

HITT Marking Devices

National Stencil & Sign

Rubber Stamps R Us



2019

JRS Sign Supply Catalog



Sign Frames & Holders // Laser & Rotary Engraving Materials
Braille & ADA Supplies // Badge Accessories // Sign Supplies

www.HittMarking.com



Holders & Frames

JRS has become the industry leader in the manufacturing of sign frames and holders in the U.S.A. We have developed a standard which ensures the highest quality products and complete customer satisfaction. Producing our wide range of products solely in America, we are proud to give our customers exactly what they want. We will make our quality frames and holders to any customized specifications asked for in a timely process.

In this section you find a wide assortment of standard sizes for our desk holders, corridor brackets, wall holders, desk bases and extrusions.

You can also view our popular selection of custom frames with a wide variety of options including lenses, dividers and anodized colors.

All JRS Holders & Frames:
**MADE WITH PRIDE,
MADE IN THE USA**



Desk Holders

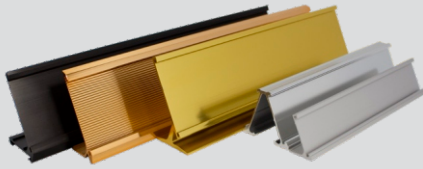

JRS desk holders are made from a premium aluminum billet and are available in multiple styles and sizes. Holders for desks, counters, walls and doors enhance the signs that serve you daily.

PRODUCT DETAILS

Material: Aluminum
 Polished Colors: Polished Silver, Polished Rose Gold, Polished Yellow Gold
 Satin Colors: Satin Silver, Satin Rose Gold, Satin Yellow Gold, Arch Bronze
 Other Colors: Matte Black, Raw Aluminum
 Additional Info: Custom Lengths up to 39" available

Traditional Desk Holder

Part Number	Insert Height	Material Thickness	Standard Lengths			
85	.75"	1/16"	4"	6"	8"	10"
25	1"	1/16"	6"	7"	8"	10"
54	1.25"	1/16"	6"	8"	10"	
70	1.5"	1/16"	7.5"	8"	10"	
19	1.5"	1/8"	7.5"	8"	10"	
14	1.625"	1/16"	7.5"	8"	10"	
48	2"	1/16"	8"	10"	12"	
11	2"	1/8"	6"	8"	10"	12"
483	2"	3/32"	8"	10"	12"	
16	3.25"	1/8"	10"	12"		



Traditional Desk Holder

Ribbed Desk Holder



Ribbed Desk Holders

Part Number	Insert Height	Material Thickness	Standard Lengths		
59	2"	1/16"	8"	10"	12"

Ribbed desk holders hold a 2 inch by 1/16 inch thick material and provide a professional and elegant solution for desk nameplates and directional signage with a thicker beveled border compared to the traditional desk holder.

Raised Desk Holder

Part Number	Insert Height	Material Thickness	Standard Lengths		
31	1.5"	1/16"	8"	9"	10"
30	2"	1/16"	8"	10"	

Raised desk holders are like traditional desk holders but have a fixed base which elevates the holder of the table.

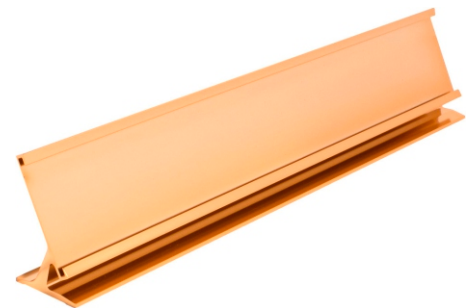

Raised Desk Holder

Colors portrayed are for reference only and are similar but not exact matches to the actual material colors. Contact us for samples to color match materials. Custom colors may have extended lead times.

Desk Holders



PRODUCT DETAILS

Material: Aluminum
 Polished Colors: Polished Silver, Polished Rose Gold, Polished Yellow Gold
 Satin Colors: Satin Silver, Satin Rose Gold, Satin Yellow Gold, Arch Bronze
 Other Colors: Matte Black, Raw Aluminum
 Additional Info: Custom Lengths up to 39" available

JRS desk holders are made from a premium aluminum billet and are available in multiple styles and sizes. Holders for desks, counters, walls and doors enhance the signs that serve you daily.



Flip Desk Holders

Flip Desk Holder

Part Number	Insert Height A	Insert Height B	Material Thickness	Standard Lengths	
60	2"	1.5"	1/16"	8"	10"

Two slot lip holders are perfect for quickly changing the message by flipping the holder to display the plate on the underside.

Double Sided Tent Desk Holder

Part Number	Insert Height A	Insert Height B	Material Thickness	Standard Lengths		
71	1.25"	1.25"	1/16"	6"	8"	10"
33	2"	2"	1/16"	8"	10"	

Double sided tent holders are perfect for quickly changing the message by rotating the holder to display the plate on the backside.



Double Sided Tent Holders



2-Slot Desk Holders

2-Slot Desk Holder

Part Number	Top Slot Height	Bottom Height	Material Thickness	Standard Lengths			
23	2"	1.5"	1/16"	8"	9"	10"	12"
61	1"	1.25"	1/16"	8"	10"		

2-Slot desk holders are like traditional desk holders but have two slots stacked.

Desk Holder with Pens

Part Number	Insert Height	Material Thickness	Standard Lengths	
34	2"	1/16"	8"	10"

Desk holders with pens are like traditional desk holders but have two pen holders and a slot for business cards. Only available in Polished Rose Gold and Polished Silver.



Desk Holder w/ Pens

Colors portrayed are for reference only and are similar but not exact matches to the actual material colors. Contact us for samples to color match materials. Custom colors may have extended lead times.

Desk Bases

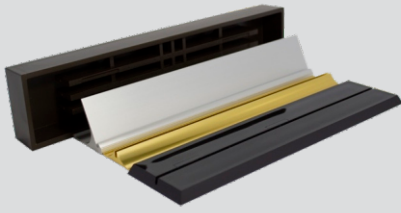

Desk and counter bases are designed to support both small and large signs by having a single base slot and no top channel. JRS desk bases are available in multiple styles and come in both plastic and aluminum.

PRODUCT DETAILS

Material: Aluminum
 Polished Colors: Polished Silver, Polished Rose Gold, Polished Yellow Gold
 Satin Colors: Satin Silver, Satin Rose Gold, Satin Yellow Gold, Arch Bronze
 Other Colors: Matte Black, Raw Aluminum
 Additional Info: Custom Lengths up to 39" available

Traditional Desk Base

Part Number	Base Depth	Material Thickness	Max. Sign Height	Standard Lengths				
15	3/4"	1/16"	2"	6"	7.5"	8"	10"	12"
50	15/16"	1/16"	3"	6"	8"	10"		
97	1-7/16"	1/16"	7"	8"	10"	12"		
17	1-3/32"	1/8"	4"	8"	10"	12"		
55	2-3/16"	1/8"	8"	8"	10"	12"		



Traditional Desk Base

Business Card Desk Base



Business Card Desk Base

Part Number	Base Depth	Material Thickness	Max. Sign Height	Standard Length
40	1.25"	1/16"	3"	3.75"

Business card desk bases have a slot for a nameplate or message and a slot for storing business cards.

Vertical Desk Base

Part Number	Base Depth	Material Thickness	Max. Sign Height	Standard Lengths		
35	1.25"	1/16"	6"	6"	8"	10"
42	1.25"	1/8"	6"	6"	8"	10"
22	2.5"	1/8"	12"	6"	8"	10"
39	1.25"	3/32"	6"	6"	8"	10"

Vertical desk bases allow the nameplate or message to be mounted vertically and also allows the sign to be rotated displaying a message on the backside.



Vertical Desk Base

Colors portrayed are for reference only and are similar but not exact matches to the actual material colors. Contact us for samples to color match materials. Custom colors may have extended lead times.

Desk Bases



PRODUCT DETAILS

Material: Aluminum
 Polished Colors: Polished Silver, Polished Rose Gold, Polished Yellow Gold
 Satin Colors: Satin Silver, Satin Rose Gold, Satin Yellow Gold, Arch Bronze
 Other Colors: Matte Black, Raw Aluminum
 Additional Info: Custom Lengths up to 39" available

Desk and counter bases are designed to support both small and large signs by having a single base slot and no top channel. JRS desk bases are available in multiple styles and come in both plastic and aluminum.

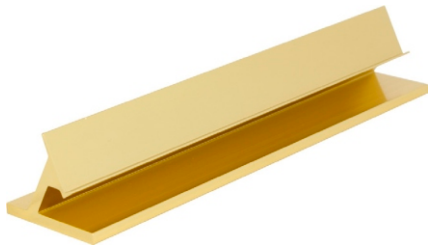

Raised Desk Base

Raised Desk Base

Part Number	Base Depth	Shelf Depth	Max. Sign Height	Standard Lengths	
111	1-3/8"	1/8"	4"	6"	9"

Raised desk bases have a fixed base which elevates the holder of the table.

Low Profile Desk Base

Part Number	Base Depth	Material Thickness	Max. Sign Height	Standard Lengths	
74	1.5"	1/8"	5"	6"	9"

Low profile desk bases provide a streamline alternative to the traditional desk holders.



Low Profile Desk Base



Vertical Grip Desk Base

Vertical Grip Desk Base

Part Number	Base Depth	Material Thickness	Max. Sign Height	Standard Lengths		
73	2"	1/8"	12"	6"	9"	12"

Vertical grip desk bases allow the nameplate or message to be mounted vertically and also allows the sign to be rotated displaying a message on the backside. These desk bases also include a special grip to lock in the material.

Desk Bases

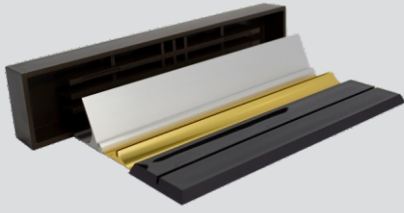

Desk and counter bases are designed to support both small and large signs by having a single base slot and no top channel.

Desk Bars are designed as a simple architectural nameplate holder or counter sign.

PRODUCT DETAILS

Material: Plastic
 P100 Colors: Black, Clear
 Desk Bar Colors: Almond, Arch Brown, Black, Brown, Medium Gray, Pewter, White
 P220 Colors: Black

Plastic Desk Base

Part Number	Base Depth	Material Thickness	Max. Sign Height	Standard Lengths
P100	2"	1/16"	6"	8" 10"

Acrylic desk bases are a low profile plastic alternative to the aluminum holders. Available in black and clear only. Slot Depth of 1/8".



Plastic Desk Bases



Plastic Desk Bars

Plastic Desk Bar

Part Number	Corner Style	Inside Dimensions
7029	5/16" Radius	1-3/4" x 9-1/8"
8029	Square	1-3/4" x 9-1/8"

Available Colors						
Almond	Arch Brown	Black	Brown	Medium Gray	Pewter	White

Desk Bars are designed as a simple architectural nameplate holder or counter sign. Comes with a 1" thick base and supports 1/16" and 1/8" thick materials. Lenses can be custom ordered in a .060" thick Matte/Clear material.

Universal Plastic Desk Base

Part Number	Base Depth	Base Height	Width
P220	1-1/8"	1-1/8"	2-5/16"

The JRS P220 Plastic Desk Base is perfect for attaching to a lat plate to quickly create a great looking desk signage. Requires adhesive to mount. Available in black only.



P220 Desk Base

Wall Holders



PRODUCT DETAILS

Material: Aluminum
 Polished Colors: Polished Silver, Polished Rose Gold, Polished Yellow Gold
 Satin Colors: Satin Silver, Satin Rose Gold, Satin Yellow Gold, Arch Bronze
 Other Colors: Matte Black, Raw Aluminum
 Additional Info: Custom Lengths up to 39" available

JRS wall holders are made from a premium aluminum billet and are available in multiple styles and sizes. Holders for desks, counters, walls and doors enhance the signs that serve you daily.

Mounting holes are standard for all inserts with heights between 1-1/4" – 4" and lengths 4" – 24". Custom holes can be requested.

Traditional Wall Holder

Part Number	Insert Height	Material Thickness	Standard Lengths					
86	.5"	1/16"	4"	6"	8"	10"	12"	39"
100	.625"	1/16"	4"	6"	8"	10"	12"	39"
44	.75"	1/16"	4"	6"	8"	10"	12"	39"
28	1"	1/16"	4"	6"	8"	10"	12"	39"
47	1.25"	1/16"	4"	6"	8"	10"	12"	39"
29	1.5"	1/16"	4"	6"	8"	10"	12"	39"
46	1.625"	1/16"	4"	6"	8"	10"	12"	39"
87	1.75"	1/16"	4"	6"	8"	10"	12"	39"
36	2"	1/16"	4"	6"	8"	10"	12"	39"
89	2.5"	1/16"	4"	6"	8"	10"	12"	39"
37	3"	1/16"	4"	6"	8"	10"	12"	39"
49	4"	1/16"	4"	6"	8"	10"	12"	39"
206	4-13/16"	1/16"		6"	8"	10"		39"
95	1.5"	1/8"	4"	6"	8"	10"	12"	39"
88	1.75"	1/8"	4"	6"	8"	10"	12"	39"
94	2"	1/8"	4"	6"	8"	10"	12"	39"
90	2.5"	1/8"	4"	6"	8"	10"	12"	39"
52	3"	1/8"	4"	6"	8"	10"	12"	39"
51	4"	1/8"	4"	6"	8"	10"	12"	39"
363	2"	3/32"	4"	6"	8"	10"	12"	39"



#36 Silver 10"



#52 Black 12"



#86 Polished Rose Gold 12"

Wall Holders



JRS wall holders are made from a premium aluminum billet and are available in multiple styles and sizes. Holders for desks, counters, walls and doors enhance the signs that serve you daily.

PRODUCT DETAILS

Material: Aluminum
 Polished Colors: Polished Silver, Polished Rose Gold, Polished Yellow Gold
 Satin Colors: Satin Silver, Satin Rose Gold, Satin Yellow Gold, Arch Bronze
 Other Colors: Matte Black, Raw Aluminum
 Additional Info: Custom Lengths up to 39" available

Ribbed Wall Holder

Part Number	Insert Height	Material Thickness	Standard Lengths					
56	1"	1/16"	4"	6"	8"	10"	12"	39"
57	1.5"	1/16"	6"	8"	10"	39"		
58	2"	1/16"	8"	10"	12"	39"		



Ribbed Wall Holder

Ribbed wall holders provide a thicker beveled border compared to the traditional aluminum holder.

Directory Wall Holder



Directory Wall Holders

Part Number	Insert Height	Material Thickness	Standard Length			
114	.75"	1/16"	6"	8"	10"	39"
103	1"	1/16"	6"	8"	10"	39"
116	1.5"	1/16"	6"	8"	10"	39"
117	2"	1/16"	6"	8"	10"	39"
118	3"	1/16"	6"	8"	10"	39"

Directory wall holders can be stacked with other single channel or multiple channel wall holders to provide a directory style layout.

2-Slot Wall Holder

Part Number	Insert Height A	Insert Height B	Material Thickness	Standard Lengths			
110	.75"	.75"	1/16"	6"	8"	10"	39"
108	.75"	1.25"	1/16"	6"	8"	10"	39"
104	1"	1"	1/16"	6"	8"	10"	39"
107	1"	1.5"	1/16"	6"	8"	10"	39"
115	1"	2"	1/16"	6"	8"	10"	39"

2-Slot wall holders can be used for directory signs and can be stacked with other single channel or multiple channel wall holders to provide additional directory slots.

Directory 2-Slot and 3-Slot wall holders can be used in Euro Frame System and Flex Frames.



2-Slot Wall Holder

Wall Holders



PRODUCT DETAILS

Material: Aluminum
 Polished Colors: Polished Silver, Polished Rose Gold, Polished Yellow Gold
 Satin Colors: Satin Silver, Satin Rose Gold, Satin Yellow Gold, Arch Bronze
 Other Colors: Matte Black, Raw Aluminum
 Additional Info: Custom Lengths up to 39" available

JRS wall holders are made from a premium aluminum billet and are available in multiple styles and sizes. Holders for desks, counters, walls and doors enhance the signs that serve you daily.

Mounting holes are standard for all inserts with heights between 1-1/4" – 4" and lengths 4" – 24".



3-Slot Wall Holders

3-Slot Wall Holder

Part Number	Insert Height	Material Thickness	Standard Lengths			
109	.75"	1/16"	6"	8"	10"	39"
106	1"	1/16"	6"	8"	10"	39"
112	1.5"	1/16"	6"	8"	10"	39"

3-Slot wall holders can be used for directory signs and can be stacked with other single channel or multiple channel wall holders to provide additional directory slots.

Directory 2-Slot and 3-Slot wall holders can be used in Euro Frame System and Flex Frames.

6-Slot Wall Holder

Part Number	Insert Height	Material Thickness	Standard Lengths			
202	.5"	1/16"	6"	8"	10"	39"

6-Slot wall holders can be used for directory signs and can be stacked with other single channel or multiple channel wall holders to provide additional directory slots.



6-Slot Wall Holders



7-Slot Wall Holders

7-Slot Wall Holder

Part Number	Insert Height	Material Thickness	Standard Lengths			
203	.625"	1/16"	6"	8"	10"	39"

7-Slot wall holders can be used for directory signs and can be stacked with other single channel or multiple channel wall holders to provide additional directory slots. Each slot in the 7-Slot Directory Wall Holder is 5/8" high.

Corridor Brackets



Corridor brackets are designed to make corridor wayfinding signage simple. Holders for desks, counters, walls and doors enhance the signs that serve you daily.

PRODUCT DETAILS

Material: Aluminum
 Polished Colors: Polished Silver, Polished Rose Gold, Polished Yellow Gold
 Satin Colors: Satin Silver, Satin Rose Gold, Satin Yellow Gold, Arch Bronze
 Other Colors: Matte Black, Raw Aluminum
 Additional Info: Custom Lengths up to 39" available

Corridor Bracket

Part Number	Base Width	Material Thickness	Standard Lengths													
			2"	3"	4"	5"	6"	8"	10"	12"	39"					
38	2.5"	1/8"														

Corridor brackets are designed to make corridor wayfinding signage simple. Includes screws to hold 1/8" thick materials.



Corridor Bracket



Combo Ceiling Brackets

Combo Ceiling Bracket

Part Number	Base Width	Material Thickness	Standard Length									
			2"	4"	6"	8"	9"	12"	39"			
72	2.125"	1/8"										

Combo ceiling bracket is perfect for both corridor and ceiling mounted signage. Comes with a #73 grip holder with a #94 mounting bracket which allows mounting screws to be concealed.

Mounting Bracket

Part Number	Base Width	Standard Lengths						
		2"	4"	6"	8"	12"	39"	
294	2.125"							

The 294 bracket is for both corridor and ceiling mounted signage. Comes with a #94 mounting bracket which allows mounting screws to be concealed, and a #200 universal mount.



Mounting Bracket

Universal Mount

Part Number	Base Width	Standard Length		
		6"	9"	12"
200	2"			



Universal Mount

Colors portrayed are for reference only and are similar but not exact matches to the actual material colors. Contact us for samples to color match materials. Custom colors may have extended lead times.



PRODUCT DETAILS

Material: Aluminum
 Polished Colors: Polished Silver, Polished Rose Gold, Polished Yellow Gold
 Satin Colors: Satin Silver, Satin Rose Gold, Satin Yellow Gold, Arch Bronze
 Other Colors: Matte Black, Raw Aluminum
 Additional Info: Custom Lengths up to 39" available

JRS Extrusions can be used to build your own custom mounting solution, use multiple extrusion to create custom sized slots, directory frames, or wayfinding signage. All extrusions are available in a bright polished or satin brushed anodized aluminum finish and come in 39" lengths.



J Slot Extrusion

J Slot Extrusion

Part Number	Material Thickness	Extrusion Height	Extrusion Depth	Standard Length
75	1/16"	3/8"	3/16"	39"
83	1/8"	1/2"	1/4"	39"

T Divider Extrusion

Part Number	Material Thickness	Extrusion Width	Extrusion Depth	Standard Length
76	1/16"	11/16"	3/16"	39"
84	1/8"	7/8"	1/4"	39"

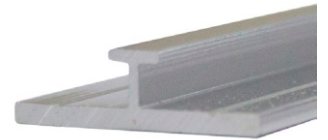

T Divider Extrusion

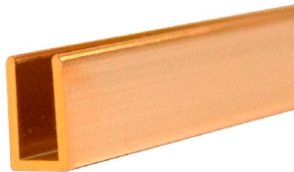

Cap Extrusion

Cap Extrusion

Part Number	Material Thickness	Extrusion Height	Extrusion Depth	Standard Length
27	1/8"	3/8"	3/16"	39"

2-Slot J Channel Extrusion

Part Number	Material Thickness	Extrusion Height	Extrusion Depth	Standard Length
78	1/16"	13/16"	1/4"	39"



2-Slot J Channel Extrusion

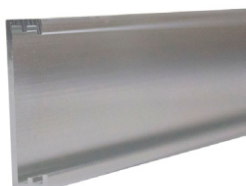

2-Slot Slider Extrusion

2-Slot Slider Extrusion

Part Number	Slot Height	Material Thickness	Extrusion Height	Extrusion Depth	Standard Lengths
77	1"	1/16"	1-1/8"	1/4"	39"

Environmentals



In our continuing effort to be a steward for the environment, we are introducing our Environmentals line of holders. Manufactured to our exacting standards for workmanship and quality from a special recycled aluminum billet that is an Environmentally Preferred Product, the Environmentals will help us as we strive to provide sustainable product solutions for your signage needs while caring for the future as well.

PRODUCT DETAILS

Material: Recycled Aluminum
 Standard Colors: Satin Yellow Gold, Satin Silver, Matte Black, Raw Aluminum
 Additional Info: Custom Lengths up to 39" available

Corridor Bracket

Part Number	Base Width	Material Thickness	Standard Lengths												
			2"	3"	4"	5"	6"	8"	10"	12"	39"				
E38	2.5"	1/8"													

Corridor brackets are designed to make corridor wayfinding signage simple. Includes screws to hold 1/8" thick materials. Screws are available in rose gold, silver and black only.



Environmental Corridor Bracket



Environmental Wall Holder

Wall Holder

Part Number	Insert Height	Material Thickness	Standard Lengths							
			4"	6"	8"	10"	12"	39"		
E28	1"	1/16"								
E29	1-1/2"	1/16"								
E36	2"	1/16"								
E37	3"	1/16"								
E49	4"	1/16"								

Mounting holes are standard for all inserts with heights between 1-1/4" – 4" and lengths 4" – 24". Custom holes can be requested.

Desk Holder

Part Number	Insert Height	Material Thickness	Standard Lengths			
			6"	7"	8"	10"
E25	1"	1/16"				
E70	1-1/2"	1/16"				
E48	2"	1/16"				



Environmental Desk Holders

Vista Clara

PRODUCT DETAILS

Material: Aluminum
 Features: 3 Anodized Finishes
 Supports Paper Insert
 3/16" Thick Acrylic Lens
 Additional Info: Not For Use Outdoors

Sleek and contemporary with a traditional appeal. Vista Clara offers a simple, yet effective solution for your identification and point of sale requirements. Each unit consists of an aluminum profile of high quality material along with a custom 3/16" thick acrylic lens bevel cut to sit flush with surface of holder.



Ordering Instructions

Choose from the options below to build your custom architectural aluminum frames. Required information includes: Frame style, length, and color.

Frame Style

VC1 (1")	VC4 (2")
VC2 (2")	VC5 (3")
VC3 (3")	

Length

VC2 and VC4 minimum length is 3-1/2".
 VC1, VC3 and VC5 minimum length is 4".

Maximum length is 39".



Vista Clara

Additional Features

Mounting Holes	No (Standard)
	Yes (Upcharge)

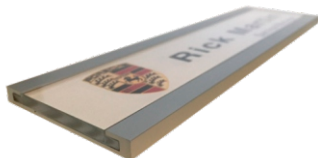
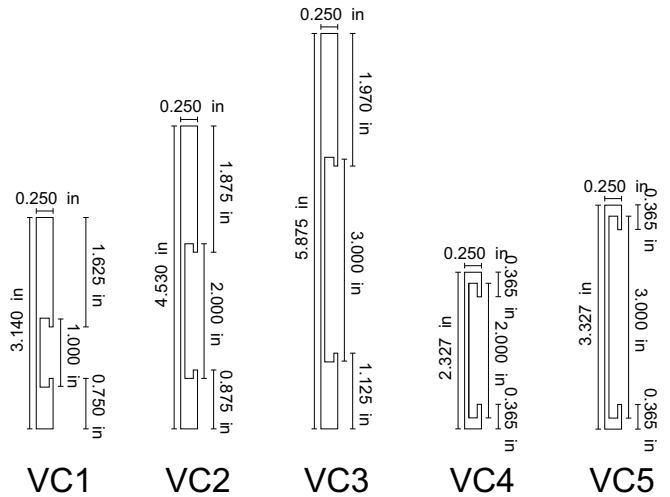

Anodized Colors

Satin Yellow Gold	Satin Silver	Matte Black
-------------------	--------------	-------------

All frames are made to order and NOT returnable. Please note when ordering, ALL frames are built using INSIDE Dimensions. Colors portrayed are for reference only and are similar but not exact matches to the actual material colors. Contact us for samples to color match materials.

Architectural Aluminum Frames

Our architectural aluminum frames are the perfect addition to any office wall, door, counter or ceiling. Architectural aluminum frames provide a simple, yet elegant frame solution to any signage. All frames are custom fabricated to your desired specifications from a continuous aluminum extrusion.

PRODUCT DETAILS

Material: Aluminum
 Features: 8 Anodized Finishes
 1/16" or 1/8" Wall Thickness
 Radius or Square Corners
 Wall, Ceiling, Counter, Desk
 Frame Styles
 Additional Info: Dividers Optional
 Custom Frames Available
 Not For Use Outdoors



Ordering Instructions

Choose from the options below to build your custom architectural aluminum frames. Required information includes: Frame style, inside dimensions, corner style, color, wall thickness, and depth.

Frame Styles

Wall / Door	Desk
Counter (Single Sided)	Counter (Double Sided)
Corridor (Single Sided)	Corridor (Double Sided)
Ceiling (Single Sided)	Ceiling (Double Sided)



Wall / Door Frame



Desk Frame

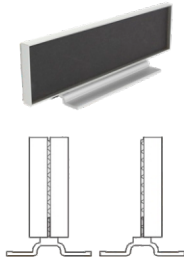

Counter Frame



Corridor Frame

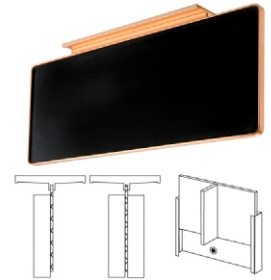

Ceiling Frame

Inside Dimensions

Minimum frame size is 2" x 4"

Desk - Maximum height of 4"

Counter & Ceiling - Maximum height of 10"

Corridor - Maximum extension from wall of 12"

Frames over 100 perimeter inches will be considered custom and will need to be quoted before fabrication.

Corners

Square Corners or Radius Corners



Anodized Colors

Polished Rose Gold

Satin Rose Gold

Polished Yellow Gold

Satin Yellow Gold

Polished Silver

Satin Silver

Matte Black

Arch Bronze

Powder coated colors are available, please contact us for more information.

All frames are made to order and NOT returnable. Please note when ordering, ALL frames are built using INSIDE Dimensions. Custom shaped aluminum frames are available. Examples include circles, triangles, ovals, and domed frames. Please call for more information or to request a quote. Colors portrayed are for reference only and are similar but not exact matches to the actual material colors. Contact us for samples to color match materials.

Architectural Aluminum Frames



PRODUCT DETAILS

Material: Aluminum
 Features: 8 Anodized Finishes
 1/16" or 1/8" Wall Thickness
 Radius or Square Corners
 Wall, Ceiling, Counter, Desk
 Frame Styles
 Additional Info: Dividers Optional
 Custom Frames Available
 Not For Use Outdoors

Our architectural aluminum frames are the perfect addition to any office wall, door, counter or ceiling. Architectural aluminum frames provide a simple, yet elegant frame solution to any signage. All frames are custom fabricated to your desired specifications from a continuous aluminum extrusion.

Wall Thickness & Frame Depth

Wall Thickness	Outside Frame Depth	Inside Frame Depth
1/16"	3/8"	3/16"
1/16"	1/2"	5/16"
1/16"	1/2"	3/16"
1/8"	1/2"	5/16"
1/8"	1/2"	3/16"

1/8" Wall Thickness

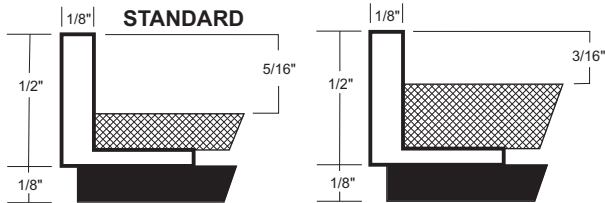

1/16" Wall Thickness

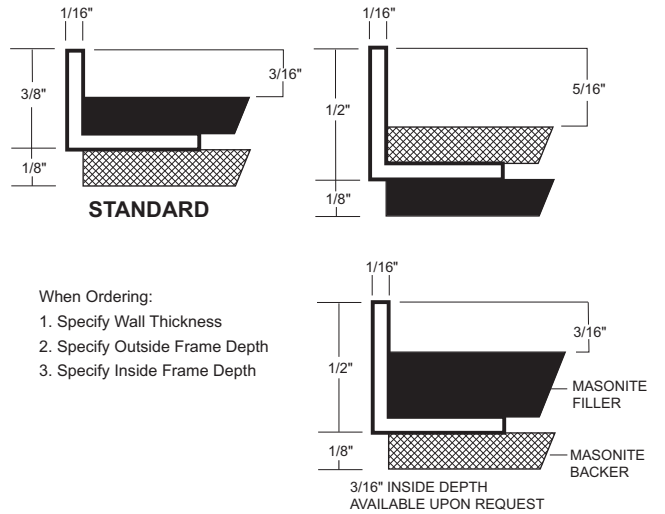

When Ordering:
 1. Specify Wall Thickness
 2. Specify Outside Frame Depth
 3. Specify Inside Frame Depth

Optional: Dividers

Frame drawings must be provided for divided frames showing inside dimension of each frame segment. Frame Backer Required.

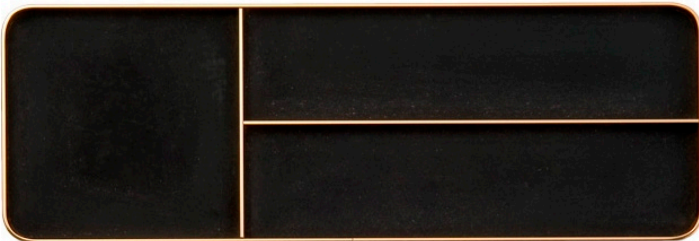

Additional Features

Frame Backer*	Masonite (Standard) Plastic (Upcharge) None
Inside Filler	Masonite (Standard) Plastic (Upcharge)
Mounting Holes	No (Standard) Yes
Metal Inside †	No (Standard) Yes (Upcharge)

* Counter, Corridor, Desk and Ceiling frames do not come with masonite backer. Plastic Only.
 † Black paper laminated steel for magnetic inserts.

Custom Shapes

Custom shaped aluminum frames are available. Examples include circles, triangles, ovals, and domed frames. Please call for more information or a quote.



All frames are made to order and NOT returnable. Please note when ordering, ALL frames are built using INSIDE Dimensions. Custom shaped aluminum frames are available. Examples include circles, triangles, ovals, and domed frames. Please call for more information or to request a quote. Colors portrayed are for reference only and are similar but not exact matches to the actual material colors. Contact us for samples to color match materials.

Architectural Aluminum Frames



Our architectural aluminum frames are the perfect addition to any office wall, door, counter or ceiling. Architectural aluminum frames provide a simple, yet elegant frame solution to any signage. All frames are custom fabricated to your desired specifications from a continuous aluminum extrusion.

PRODUCT DETAILS

Material: Aluminum
 Features: 8 Anodized Finishes
 1/16" or 1/8" Wall Thickness
 Radius or Square Corners
 Wall, Ceiling, Counter, Desk
 Frame Styles
 Additional Info: Dividers Optional
 Custom Frames Available
 Not For Use Outdoors

Architectural Aluminum Frames Part Numbers

Frame Style	Wall Thickness	Corners	Part Number
Wall / Door	1/16"	Square	240
Wall / Door	1/16"	Radius	340
Wall / Door	1/8"	Square	540
Wall / Door	1/8"	Radius	640

Frame Style	Wall Thickness	Corners	Part Number
Desk	1/16"	Square	211
Desk	1/16"	Radius	311
Desk	1/8"	Square	511
Desk	1/8"	Radius	611

Frame Style	Sides	Wall Thickness	Corners	Part Number
Counter	Single	1/16"	Square	221
Counter	Double	1/16"	Square	222
Counter	Single	1/16"	Radius	321
Counter	Double	1/16"	Radius	322
Counter	Single	1/8"	Square	521
Counter	Double	1/8"	Square	522
Counter	Single	1/8"	Radius	621
Counter	Double	1/8"	Radius	622

Frame Style	Sides	Wall Thickness	Corners	Part Number
Corridor	Single	1/16"	Square	261
Corridor	Double	1/16"	Square	262
Corridor	Single	1/16"	Radius	361
Corridor	Double	1/16"	Radius	362
Corridor	Single	1/8"	Square	561
Corridor	Double	1/8"	Square	562
Corridor	Single	1/8"	Radius	661
Corridor	Double	1/8"	Radius	662

Frame Style	Sides	Wall Thickness	Corners	Part Number
Ceiling	Single	1/16"	Square	271
Ceiling	Double	1/16"	Square	272
Ceiling	Single	1/16"	Radius	371
Ceiling	Double	1/16"	Radius	372
Ceiling	Single	1/8"	Square	571
Ceiling	Double	1/8"	Square	572
Ceiling	Single	1/8"	Radius	671
Ceiling	Double	1/8"	Radius	672

All frames are made to order and NOT returnable. Please note when ordering, ALL frames are built using INSIDE Dimensions. Custom shaped aluminum frames are available. Examples include circles, triangles, ovals, and domed frames. Please call for more information or to request a quote. Colors portrayed are for reference only and are similar but not exact matches to the actual material colors. Contact us for samples to color match materials.

Mini-Directory & Changeable Message Frames



PRODUCT DETAILS

Material: Aluminum
 Features: 8 Anodized Finishes
 1/16" or 1/8" Wall Thickness
 Radius or Square Corners
 Additional Info: Not For Use Outdoors
 Custom Sizes Available

Provide simple to read directories with these pre-formatted Mini-Directory frames.

Unique changeable message frames are perfect for quick status updates and identification.

Mini-Directory Ordering Instructions

Choose from the options below to build your custom mini-directory frame. Required information includes: Frame size, wall thickness, corner style, and color.

Frame Size	Wall Thickness	Corners	Part Number
6" x 6"	1/16"	Square	242-66
6" x 6"	1/16"	Radius	342-66
6" x 6"	1/8"	Square	542-66
6" x 6"	1/8"	Radius	642-66
8" x 8"	1/16"	Square	242-88
8" x 8"	1/16"	Radius	342-88
8" x 8"	1/8"	Square	542-88
8" x 8"	1/8"	Radius	642-88

6" x 6" Mini-Directory
 Features a one piece magnetic backed extrusion with six 1/2" x 6" slots for easy plate changes.

8" x 8" Mini-Directory
 Features a one piece magnetic backed extrusion with seven 5/8" x 8" slots for easy plate changes.

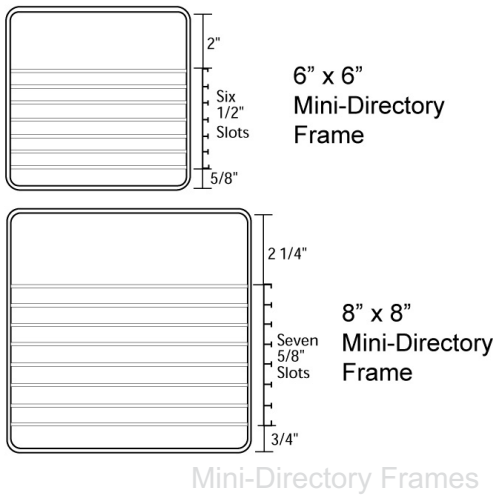

Changeable Message Ordering Instructions

Choose from the options below to build your custom changeable message frame. Required information includes: Frame size, wall thickness, corner style, and color.

Frame Size	Wall Thickness	Corners	Part Number
6" x 6"	1/16"	Square	241-66
6" x 6"	1/16"	Radius	341-66
6" x 6"	1/8"	Square	541-66
6" x 6"	1/8"	Radius	641-66
8" x 8"	1/16"	Square	241-88
8" x 8"	1/16"	Radius	341-88
8" x 8"	1/8"	Square	541-88
8" x 8"	1/8"	Radius	641-88
2" x 13"	1/16"	Square	244-23
2" x 13"	1/16"	Radius	344-23
2" x 13"	1/8"	Square	544-23
2" x 13"	1/8"	Radius	644-23

6" x 6" Changeable Message Frame
 Contains a 1" x 6" extrusion for a 1/16" message plate and a secondary 1/16" slot for a 1" x 3" cover plate to display alternating messages.

8" x 8" Changeable Message Frame
 Contains a 1" x 8" extrusion for a 1/16" message plate and a secondary 1/16" slot for a 1" x 4" cover plate to display alternating messages.

2" x 13" Changeable Message Frame
 Designed for 2" x 10" message plate to slide right to left to expose alternating messages on each side.

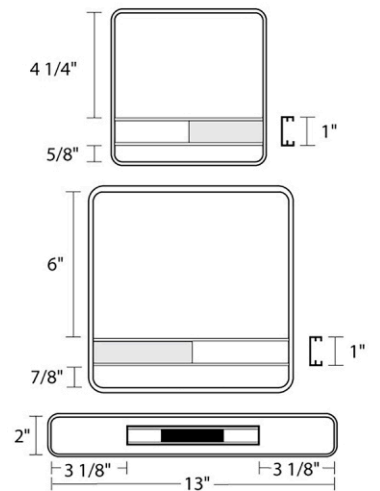

Changeable Message Frames

Anodized Colors

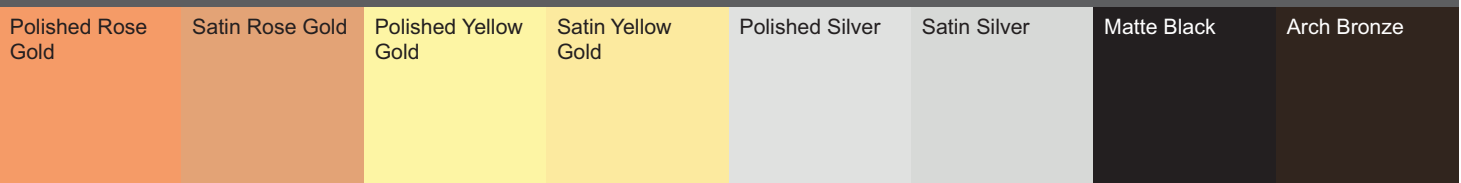

All frames are made to order and NOT returnable. Please note when ordering, ALL frames are built using INSIDE Dimensions. Colors portrayed are for reference only and are similar but not exact matches to the actual material colors. Contact us for samples to color match materials.



Heavy Architectural Frames

Heavy Architectural Frames are perfect for a deep bold presence on any desk or counter. Fabricated from a single heavy 1/8" thick wall extrusion with either a 1-1/4" or 1-3/4" outside depth and a 5/16" inside depth.

PRODUCT DETAILS

Material: Aluminum
 Features: 8 Anodized Finishes
 1-3/4" or 1-1/4" Frame Thickness
 5/16" Inside Depth
 Single or Double Sided
 1/8" Wall Thickness
 Additional Info: Not For Use Outdoors

Heavy Architectural Ordering Instructions

Choose from the options below to build your custom changeable message frame. Required information includes: Frame thickness, sides, inside dimensions, and color.

Frame Thickness	Sides	Inside Depth	Part Number
1-3/4"	Single-Sided	5/16"	932S
1-3/4"	Double-Sided	5/16"	932D
1-1/4"	Single-Sided	5/16"	942S
1-1/4"	Double-Sided	5/16"	942D



Heavy Architectural Aluminum Frame

Inside Dimensions

Minimum frame height is 2"
 Maximum perimeter is 70"



1-1/4" Thick Frame



1-3/4" Thick Frame



Front View

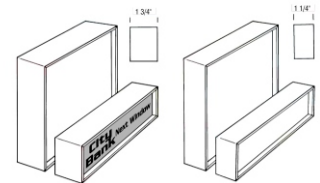

Frame Thickness

Anodized Colors

Polished Rose Gold	Satin Rose Gold	Polished Yellow Gold	Satin Yellow Gold	Polished Silver	Satin Silver	Matte Black	Arch Bronze
--------------------	-----------------	----------------------	-------------------	-----------------	--------------	-------------	-------------

All frames are made to order and NOT returnable. Please note when ordering, ALL frames are built using INSIDE Dimensions. Colors portrayed are for reference only and are similar but not exact matches to the actual material colors. Contact us for samples to color match materials.

Aluminum Frames with Lenses



PRODUCT DETAILS

- Material: Aluminum
 Features: 8 Anodized Finishes
 .060" Matte/Clear Lens
 7/16" Outside Depth
 1/8" Wall Thickness
 Paper to 1/8" Material
 Additional Info: Dividers Optional
 Not For Use Outdoors
 Lens Included in Pricing

Matte clear acrylic based lenses are laser cut to snap in and out of anodized aluminum frames, round or square cornered.

Made of a semi-flexible acrylic material with tabs that snap into a small channel in the frame extrusion.

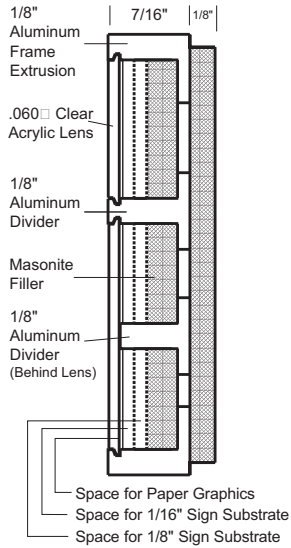

Aluminum Frame with Lenses

Ordering Instructions

Choose from the options below to build your custom architectural aluminum frames. Required information includes: Frame style, inside depth, inside dimensions, corner style, and color.

Frame Style	Corners	Wall Thickness	Part Number
Wall / Door	Square	1/8"	140
Wall / Door	Radius	1/8"	940
Desk	Square	1/8"	141
Desk	Radius	1/8"	941

Aluminum frames with lense feature a .060" Matte/Clear lens, a 7/16" outside frame depth, 1/8" thick masonite backer and 1/8" wall thickness.

Lenses can be screen printed and have tactile or Braille mounted to them while exposing a paper graphic.

Inside Depth (Material Thickness)

Paper	1/32"
1/16"	1/8"

Inside Dimensions

Minimum frame size is 2" x 4"
Desk - Max Height 4"
 Max lens size is 200 sq. in.

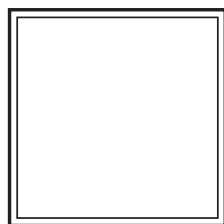
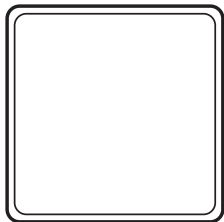

Corners

Square Corners or Radius Corners



All frames are made to order and NOT returnable. Please note when ordering, ALL frames are built using INSIDE Dimensions. Colors portrayed are for reference only and are similar but not exact matches to the actual material colors. Contact us for samples to color match materials.

Aluminum Frames with Lenses



Matte clear acrylic based lenses are laser cut to snap in and out of anodized aluminum frames, round or square cornered.

Made of a semi-flexible acrylic material with tabs that snap into a small channel in the frame extrusion.

PRODUCT DETAILS

Material: Aluminum
 Features: 8 Anodized Finishes
 .060" Matte/Clear Lens
 7/16" Outside Depth
 1/8" Wall Thickness
 Paper to 1/8" Material
 Additional Info: Dividers Optional
 Not For Use Outdoors
 Lens Included in Pricing

Optional: Dividers

Frame drawings must be provided for divided frames showing inside dimension of each frame segment.



Additional Features

Frame Backer	Masonite (Standard) Plastic (Upcharge) None
Inside Filler	Masonite (Standard) Plastic (Upcharge)
Mounting Holes	No (Standard) Yes (Upcharge)

Anodized Colors

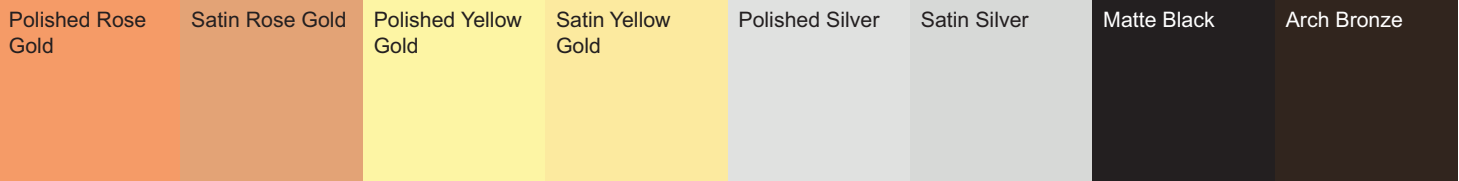

All frames are made to order and NOT returnable. Please note when ordering, ALL frames are built using INSIDE Dimensions. Colors portrayed are for reference only and are similar but not exact matches to the actual material colors. Contact us for samples to color match materials.

Premier Plus Frames



PRODUCT DETAILS

Material: Aluminum
 Features: 8 Anodized Finishes
 Supports up to 1/4" Material
 1/2" Outside Depth
 Bevel, Radius, Boxed, and
 1/4" Frame Styles
 Additional Info: Dividers Optional
 Not For Use Outdoors

Precision mitered from an extrusion of premium alloy in four professional styles: Beveled, Quarter Round, Boxed, and Quarter Inch Solid, makes this sign system a top of the line favorite.

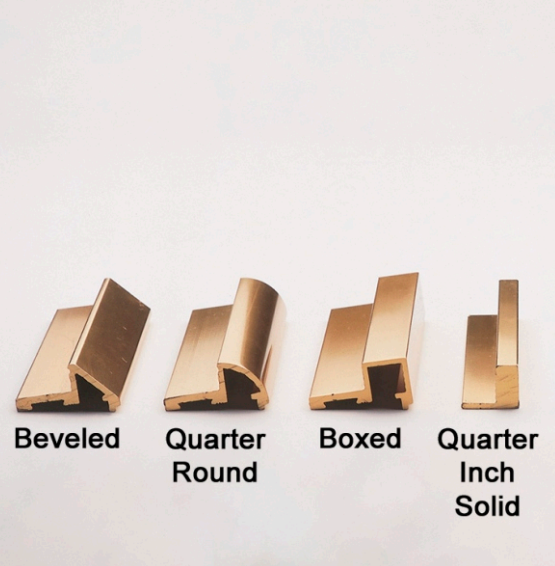

Beveled **Quarter Round** **Boxed** **Quarter Inch Solid**

Premier Plus Frame Styles

Ordering Instructions

Choose from the options below to build your custom architectural aluminum frames. Required information includes: Frame style, inside depth, inside dimensions, and color.

Frame Styles

Bevel (Style 2020)	Radius (Style 2030)
Boxed (Style 2040)	Solid (Style 2050)

Inside Dimensions

Minimum frame size is 2" x 4"
 Maximum frame size is 36" x 36"

Inside Depth

Paper Thin	3/16"
5/16"	

Paper Thin inside depth is for use with a .060" Matte/Clear lens.

Optional: Lens

.060" Matte/Clear Lens

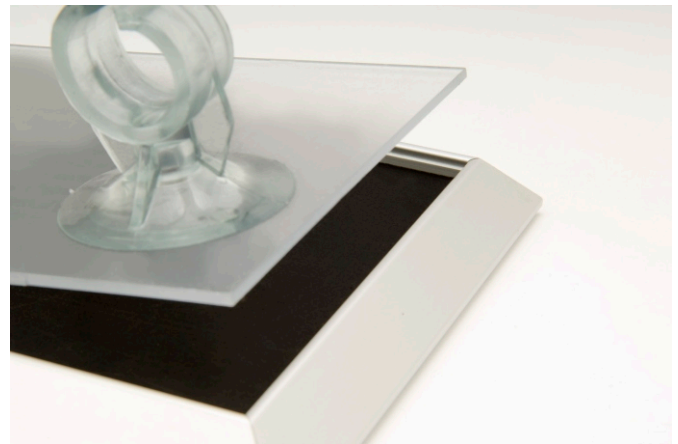

Premier Plus Frame with Lens

Anodized Colors



Powder coated colors are available for frames without a lens, please contact us for more information.

All frames are made to order and NOT returnable. Please note when ordering, ALL frames are built using INSIDE Dimensions. Colors portrayed are for reference only and are similar but not exact matches to the actual material colors. Contact us for samples to color match materials.

Premier Plus Frames



Precision mitered from an extrusion of premium alloy in four professional styles: Beveled, Quarter Round, Boxed, and Quarter Inch Solid, makes this sign system a top of the line favorite.

PRODUCT DETAILS

Material: Aluminum
 Features: 8 Anodized Finishes
 Supports up to 1/4" Material
 1/2" Outside Depth
 Bevel, Radius, Boxed, and 1/4" Frame Styles
 Additional Info: Dividers Optional
 Not For Use Outdoors

Optional: Dividers

1/8" Divider Thickness 1/4" Divider Thickness

Minimum divider length is 2".
 1/8" dividers are standard on all frames except 1/4" solid frame style.
 1/4" dividers are standard on 1/4" solid frame style.

Frame drawings must be provided for divided frames showing inside dimension of each frame segment.



Premier Plus Beveled Frame with Divider

Additional Features

Frame Backer	Masonite (Standard) Plastic (Upcharge)
Inside Filler	Masonite (Standard) Plastic (Upcharge)
Mounting Holes	No (Standard) Yes (Upcharge)
Metal Inside*	No (Standard) Yes (Upcharge)

* Metal Inside for magnetic changeable signage.

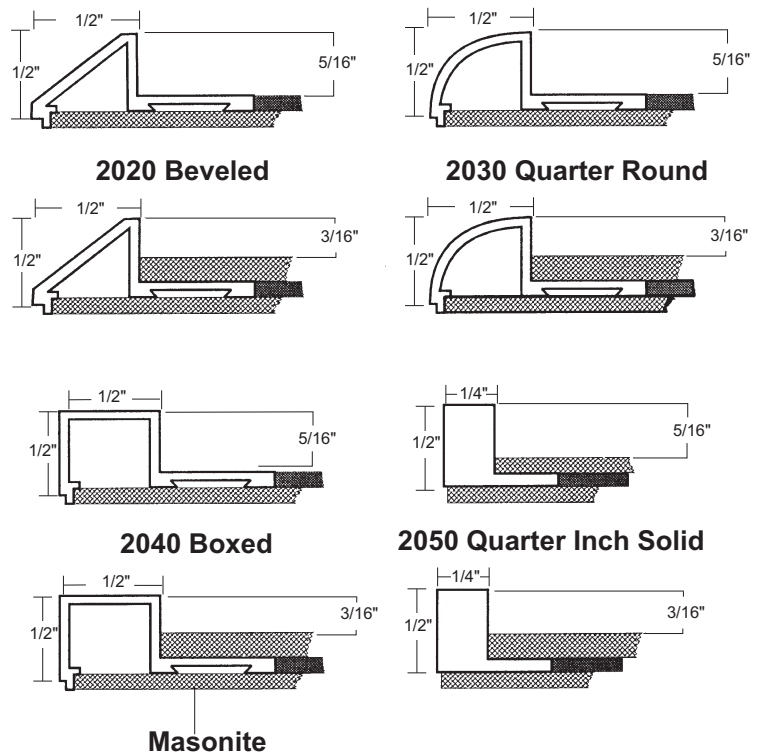

Premier Plus Frame Styles

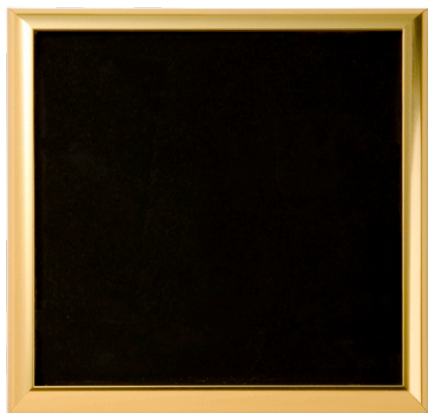

Premier Plus Quarter Round Frame

All frames are made to order and NOT returnable. Please note when ordering, ALL frames are built using INSIDE Dimensions. Colors portrayed are for reference only and are similar but not exact matches to the actual material colors. Contact us for samples to color match materials.

Premier Frames



PRODUCT DETAILS

Material: Aluminum
 Features: 8 Anodized Finishes
 Supports 1/16" Material
 1/2" Outside Depth
 Bevel, Radius, Boxed Frame
 Additional Info: Not For Use Outdoors

Precision mitered from an extrusion of premium alloy in three professional styles: Beveled, Radiused, and Boxed makes this sign system a top of the line favorite. Each style has several features that make professional signs simple.

Ordering Instructions

Choose from the options below to build your custom architectural aluminum frames. Required information includes: Frame style, inside dimensions, and color.

Frame Styles

Bevel (Style 1020)

Radius (Style 1030)

Box (Style 1040)

A trough 1/2" wide runs the entire inside perimeter of each frame which accommodates adhesive-backed 3M DUAL LOCK™ so that a tamper-resistant plate snaps in and out with the use of a suction cup.

Inside Dimensions

Minimum frame size is 2" h x 4" w
 Maximum frame size is 36" x 36"

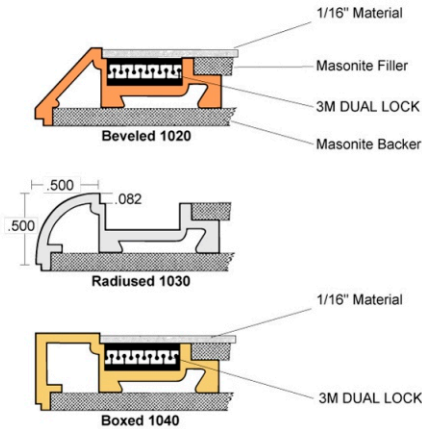

Premier Frames

Additional Features

Frame Backer	Masonite (Standard) Plastic (Upcharge)
Inside Filler	Masonite (Standard) Plastic (Upcharge)
Mounting Holes	No (Standard) Yes (Upcharge)
Metal Inside	No (Standard) Yes (Upcharge)
3M DUAL LOCK™	Page 57 (Upcharge)

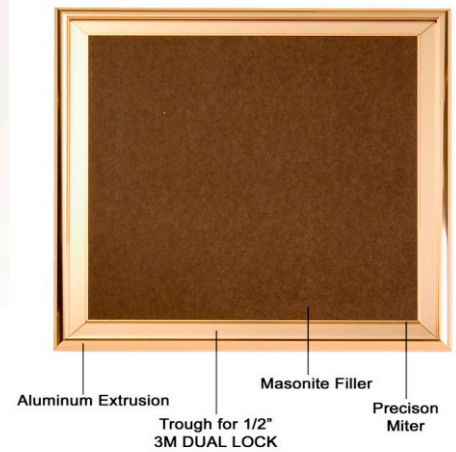

Anodized Colors

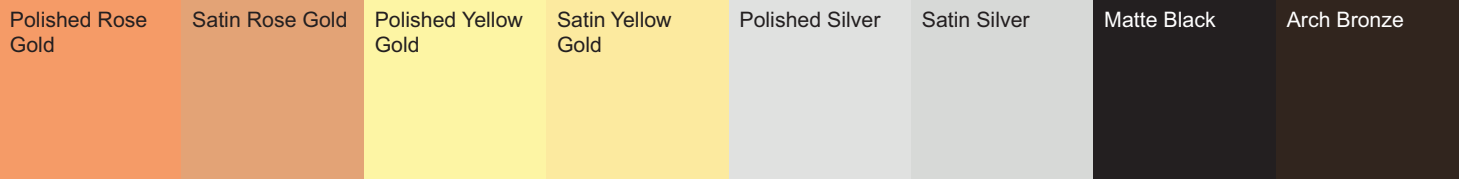

All frames are made to order and NOT returnable. Please note when ordering, ALL frames are built using INSIDE Dimensions. Colors portrayed are for reference only and are similar but not exact matches to the actual material colors. Contact us for samples to color match materials.

Curves Sign System



Innovative and cost effective. Curves adds a whole new dimension to sign frames. Curves has many applications including personnel signs, room identification and direction wayfinding signs. Curves can be mounted to a wall or partition, hung from the ceiling with fixed bracket or wire, lag mounted or used as a desk signholder.

PRODUCT DETAILS

Material: Aluminum
 Features: 8 Anodized Finishes
 Tamper Resistant
 Up to 1/16" Material
 Lens Option Available
 Additional Info: Custom Sizes Available
 Not For Use Outdoors
 Includes End Cap and Screws
 Extra Charge for Assembly

Ordering Instructions

Choose from the options below to build your custom architectural aluminum frames. Required information includes: Frame style, frame color, end cap color, end cap size, and frame length.

Frame Styles

Wall/Door Mount	Desk
Flag Mount (Single Sided)	Flag Mount (Double Sided)
Hanging Ceiling Mount (Single Sided)	Hanging Ceiling Mount (Double Sided)
Flush Ceiling Mount (Single Sided)	Flush Ceiling Mount (Double Sided)

End Cap Size

2-1/2" (Style 229)	4" (Style 230)
6" (Style 231)	8" (Style 232)
8.5" (Style 233)	9"
10"	11"
12"	

Length

Maximum frame length 39".
Flag Mount - Max Length 12".

The arc is based on the end cap. Highest point of the arc is in the middle of the end cap.

The low points of the arc are on the length sides. For Ceiling Mounts, the brackets/mounts are placed on the length dimensions. Please specify endcap placement on Flag Mount frames.



Curve Sign System

End Cap Color

Black (Plastic)	Gray (Plastic)
Satin Silver Aluminum (Upcharge)	Black Aluminum (Upcharge)

Black end caps are standard.

Additional Features

Mounting Holes	No (Standard)
	Yes (Upcharge)
Acrylic Lens*	No (Standard)
	Yes (Upcharge)

* For paper inserts



Curve End Cap



Curve Desk Frame

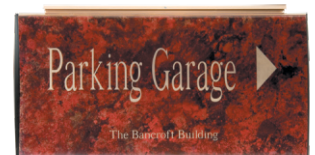

Flush Ceiling Mount

Anodized Colors

Polished Rose Gold	Satin Rose Gold	Polished Yellow Gold	Satin Yellow Gold	Polished Silver	Satin Silver	Matte Black	Arch Bronze
--------------------	-----------------	----------------------	-------------------	-----------------	--------------	-------------	-------------

All frames are made to order and NOT returnable. Please note when ordering, ALL frames are built using INSIDE Dimensions. Colors portrayed are for reference only and are similar but not exact matches to the actual material colors. Contact us for samples to color match materials.

Decorative Bars & Rails

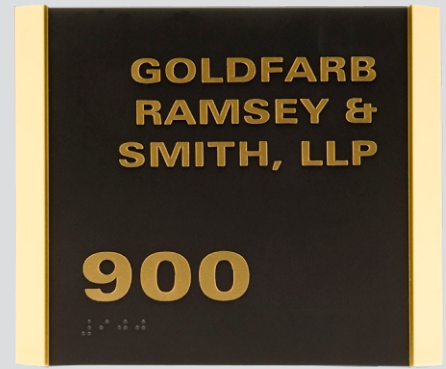

PRODUCT DETAILS

- Material: Aluminum
- Features: 4 Anodized Finishes
Up to 1/4" Thick Material
6 Frame Profiles
- Additional Info: Dividers Optional
Lens Optional
Not For Use Outdoors

Six sizes of decorative bars & rails create bold metallic borders for your signs. Options consist of bars only, 2-sided frame, and 4-sided frame. One can use equal size bars or mix two different sizes for 2-Sided frames. All four sizes can be made in to a complete four-sided frame, and all formats can snap in a matte clear lens.

Ordering Instructions

Choose from the options below to build your custom architectural aluminum frames. Required information includes: Bar/Rail style, frame style, inside dimensions, and color.



Decorative Rails

Bar / Rail Style

5/8" Bar (Style 213)	1" Bar (Style 214)
1-1/2" Bar (Style 215)	2" Bar (Style 216)
1/2" Bevel Rail (Style 208)	1/4" Quarter Round Rail (Style 217)

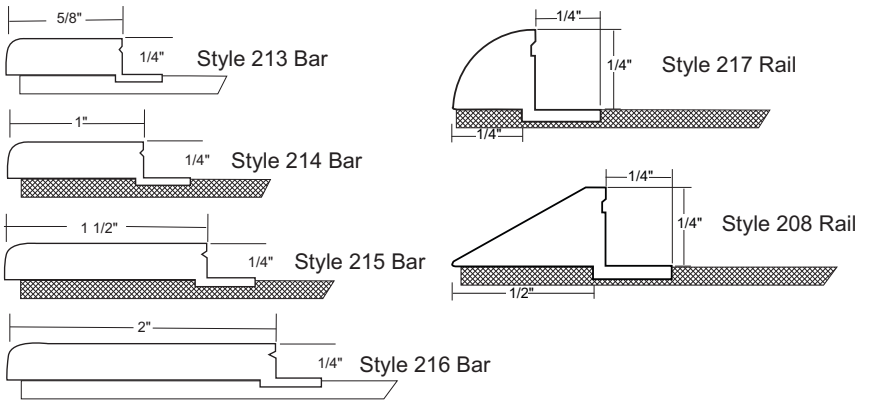

Frame Style

- Rail / Bar Only
- 2-Sided Frame
- 4-Sided Frame (Max Size 36" x 36")

Inside Dimensions

Please provide inside dimensions for frames. If ordering Rails/Bar Only, please provide only the length. 2-Sided Frames will have the rails placed on the top and bottom of the Length dimension unless otherwise specified.

Minimum frame size is 2" H x 4" L.
Maximum frame size is 39" x 39"



Anodized Colors

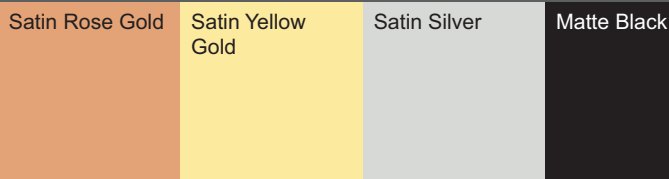

All frames are made to order and NOT returnable. Please note when ordering, ALL frames are built using INSIDE Dimensions. Colors portrayed are for reference only and are similar but not exact matches to the actual material colors. Contact us for samples to color match materials.

Decorative Bars & Rails



Six sizes of decorative bars & rails create bold metallic borders for your signs. Options consist of bars only, 2-sided frame, and 4-sided frame. One can use equal size bars or mix two different sizes for 2-Sided frames. All four sizes can be made in to a complete four-sided frame, and all formats can snap in a matte clear lens.

PRODUCT DETAILS

Material: Aluminum
 Features: 4 Anodized Finishes
 Up to 1/4" Thick Material
 6 Frame Profiles
 Additional Info: Dividers Optional
 Lens Optional
 Not For Use Outdoors

Optional: Dividers

Dividers only available for Bar Frames.

Frame drawings must be provided for divided frames showing inside dimension of each frame segment.

Dividers are not available for Bevel Rail and Quarter Round Rail.



Decorative Bar Frame with Divider

Additional Features

Frame Backer	Masonite (Standard)
	Plastic (Upcharge)
Mounting Holes	No (Standard)
	Yes (Upcharge)
Metal Inside*	No (Standard)
	Yes (Upcharge)

* Metal Inside for magnetic inserts.

Optional: Lens

.060" Matte/Clear Lens. Lens allows for paper, 1/32", 1/16", 1/8" material thicknesses.



Decorative Bar Frame with Lens

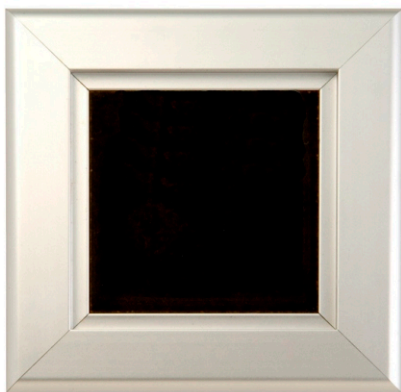

4-Sided Decorative Bar Frame

All frames are made to order and NOT returnable. Please note when ordering, ALL frames are built using INSIDE Dimensions. Colors portrayed are for reference only and are similar but not exact matches to the actual material colors. Contact us for samples to color match materials.

Euro Sign System

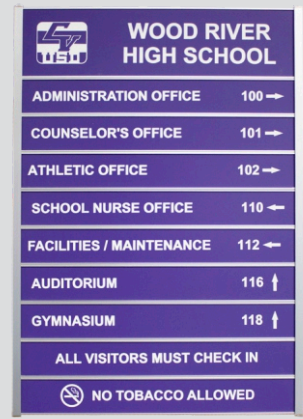

PRODUCT DETAILS

Material: Aluminum
 Features: 8 Anodized Finishes
 Supports 1/16" Thick Material
 Headers, Rows and
 Columns
 3/8" Wide Side Rails
 Additional Info: Not For Use Outdoors
 Tamper Resistant

Use as a single frame or combine the Euro Sign System with our Aluminum Holders to create tamper resistant directories, large and small. Specially designed machined screws in round or square head lock the sign assemblies in place and provide security for your signage.

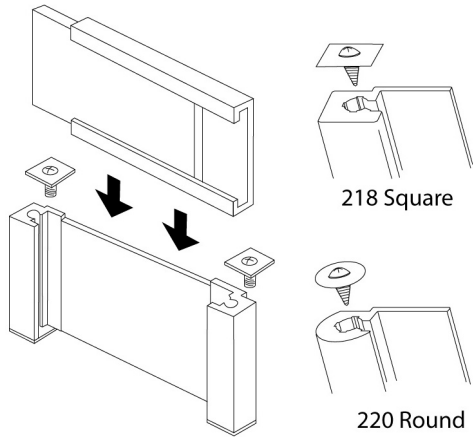

Euro Sign System

Ordering Instructions

Choose from the options below to build your custom architectural aluminum frames. Required information includes: Frame style, number of columns, number of rows, slot size, and color.

Frame Style

Square (218 Style)

Round (220 Style)

Sign assemblies are stacked to create directories which round out the Euro Sign System.

Square and round head screws are specially designed to cap of extrusions, and lock in the holder assemblies. Simply remove the top screws and slide sign assemblies out for a quick change. Screw holes are tapped for repeated use.

Screws are available in Satin Silver, Bright Rose Gold, Bright Yellow Gold, and Black.

Columns / Rows / Slot Size

Please provide number of columns, rows and slot size for frames. These options will determine overall size of frame. Headers are optional.

Frame drawings must be provided for all orders showing each holder dimension and overall inside dimension.

Minimum frame size is 2" H x 4" L.
 Maximum frame size is 39" x 39"

Refer to wall holders section to view holder insert combinations.



Euro Sign System with Round Rails

Anodized Colors

Polished Rose Gold

Satin Rose Gold

Polished Yellow Gold

Satin Yellow Gold

Polished Silver

Satin Silver

Matte Black

Arch Bronze

Euro Sign System



Use as a single frame or combine the Euro System with our Aluminum Holders to create tamper resistant directories, large and small. Specially designed machined screws in round or square head lock the sign assemblies in place and provide security for your signage.

PRODUCT DETAILS

Material:	Aluminum
Features:	8 Anodized Finishes Supports 1/16" Thick Material Headers, Rows and Columns
Additional Info:	3/8" Wide Side Rails Not For Use Outdoors Tamper Resistant

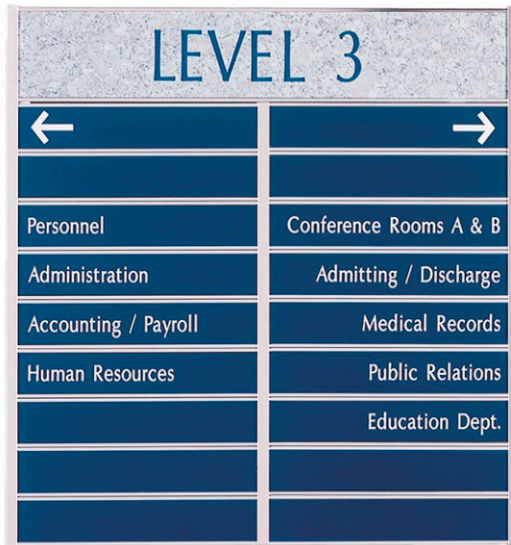

Euro Sign System with Header and 2 Columns

Optional: Header

A header can be added with a unique slot height. Length will be determined by number of columns and slot size.

Frame drawings must be provided for frames showing inside dimension of each section.

Additional Features

Frame Backer	Masonite (Standard) Plastic (Upcharge)
Mounting Holes	No (Standard) Yes (Upcharge)
Material Thickness	1/16" (Standard) 1/8" (Notched Holder - Upcharge)



Euro Sign with Square Rails

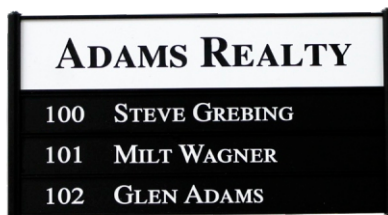

Euro Sign System



Multiple Rows and Columns

Flex Frames

HUMAN RESOURCES

CAMERON MEYER	C122
MICAELA SMITH-LAMB	C123
JESSE PELLEGRINO	C124
KYLE HANSON	C125
AUSTIN TAYLOR	C126
DAVE GRIFFITTS	C127

PRODUCT DETAILS

Material: Aluminum
 Features: 8 Anodized Finishes
 Supports up to 1/16" Material
 1/2" Outside Depth
 3/16" Square Rails
 3/16" ABS Backer
 Additional Info: Tamper Resistant
 Not For Use Outdoors

Attractive, functional and lexible, FLEX is a tamper resistant sign frame option that can be utilized for virtually any interior signage application. Square side rails with inished ends use a mix of our wall brackets that slide into the rails and are secured with a setscrew combination offering a wide range of signage options while maintaining ease of maintenance and changeability.

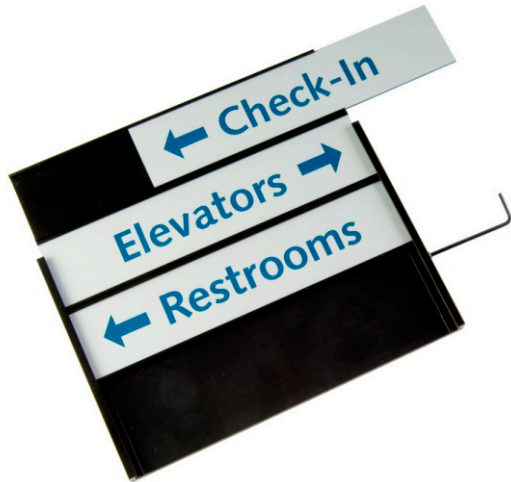

Flex Frames

Ordering Instructions

Choose from the options below to build your custom architectural aluminum frames. Required information includes: Frame style, number of rows, row height, width, and color.

Frame Style

301 Style

Dimensions

Please provide number of insert rows with and height and width of each insert. These options will determine overall size of frame.

Frame drawings must be provided for all orders showing each dimension.

Minimum total height is 2".
 Maximum height is 39".
 Minimum width is 4".
 Maximum width is 39".



Additional Features

Mounting Holes: No (Standard)
 Yes (Upcharge)

Anodized Colors

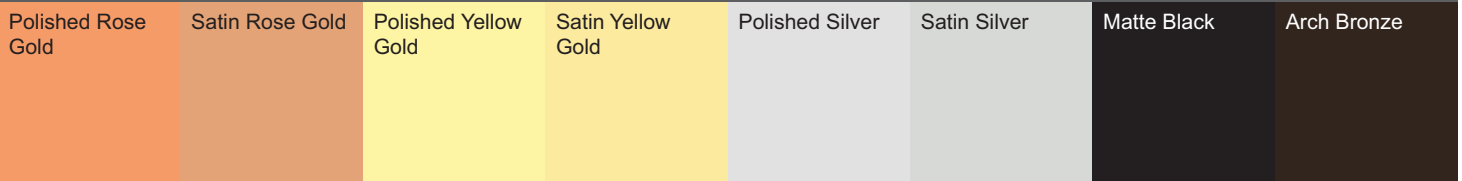

All frames are made to order and NOT returnable. Please note when ordering, ALL frames are built using INSIDE Dimensions. Colors portrayed are for reference only and are similar but not exact matches to the actual material colors. Contact us for samples to color match materials.

Coherent Window Series

Fabricated from aluminum with a styrene backer, Coherent Window Series is a simple straight-forward and economical frame system that will accommodate a variety of inserts from paper to 1/16" material. Inserts are protected by our matte-clear lens. Recommended for signage needing frequent changing.

PRODUCT DETAILS

Material: Aluminum
 Features: 8 Anodized Finishes
 Matte/Clear Lens
 Up to 1/16" Material
 1/16" Black Styrene Backer
 Additional Info: Not For Use Outdoors



Ordering Instructions

Choose from the options below to build your custom architectural aluminum frames. Required information includes: Frame style, inside dimensions, and color.

Frame Style

3575 Style

Inside Dimensions

Maximum rail length is 39".

Top and bottom square rails have a 3/8" face width and 5/16" outside depth. Side rails have a 3/32" face width.

Matte/Clear lenses are .060" thickness and are attached to the top rail for easy slide out.



Coherent Window Frame

Additional Features

Mounting Holes: No (Standard)
 Yes (Upcharge)

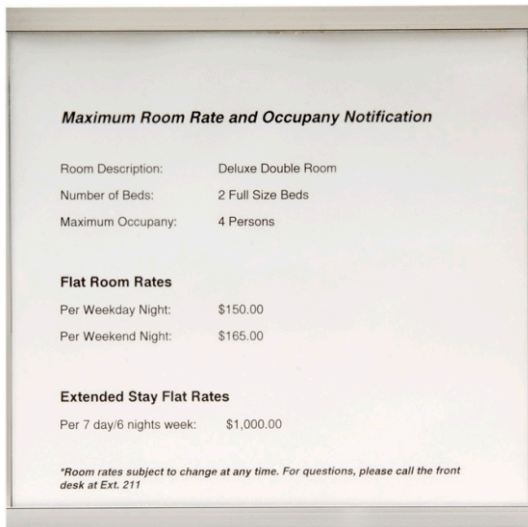

Anodized Colors

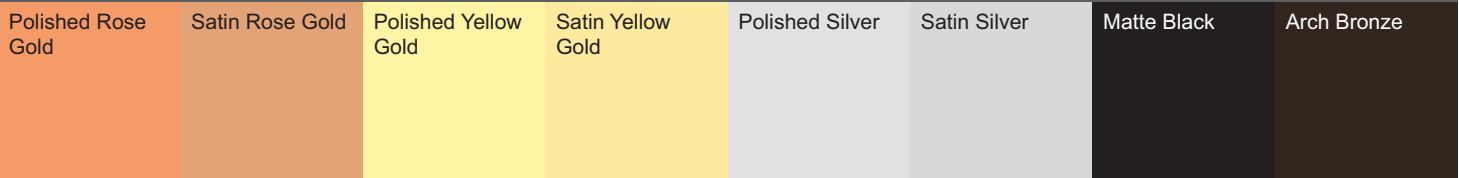

All frames are made to order and NOT returnable. Please note when ordering, ALL frames are built using INSIDE Dimensions. Colors portrayed are for reference only and are similar but not exact matches to the actual material colors. Contact us for samples to color match materials.

Xterior Outdoor Frames

PRODUCT DETAILS

Material: Aluminum
 Features: 2 Anodized Finishes
 5/8" Outside Depth
 Up to 5/16" Thick Material
 Hard Coat Finish
 Additional Info: For Use Outdoors
 Corner Angles Included

Precision mitered from a premium aluminum alloy, XTERIOR is suitable for outdoor applications. Available in two 'Hard-coat' anodized colors, Satin Yellow Gold and Satin Silver, each frame is hand assembled utilizing stamped stainless steel corner angles.



Ordering Instructions

Choose from the options below to build your custom architectural aluminum frames. Required information includes: Inside dimensions, and color.

Frame Style

3020 Style

Inside Dimensions

Minimum frame size is 3" x 3"
 Maximum frame size is 36" x 36"

Corner angles included

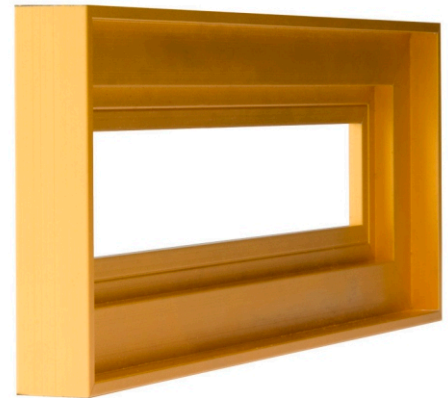

Xterior Outdoor Frame



Xterior Outdoor Frame

Additional Features

Mounting Holes	No (Standard)
	Yes (Upcharge)

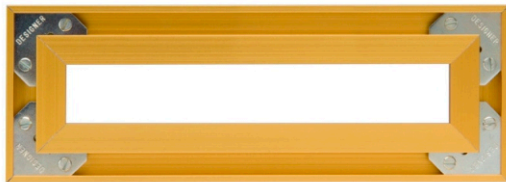

Xterior Outdoor Frame - Back View

Anodized Colors

Satin Yellow Gold	Satin Silver
-------------------	--------------



Xterior Outdoor Frame

All frames are made to order and NOT returnable. Please note when ordering, ALL frames are built using INSIDE Dimensions. Colors portrayed are for reference only and are similar but not exact matches to the actual material colors. Contact us for samples to color match materials.



EZ Signs

Create signs from any desktop computer using our E-Z Sign system. Simple user-friendly templates and within minutes you can be printing your own signs on our custom perforated sheets using your own word processing program. Perfectly suited for temporary signs, often-changed signs, informational signs or conference rooms. With the E-Z Sign system, your options only end with your imagination.

PRODUCT DETAILS

Material: Molded Plastic
 Features: 7 Color Options
 1/2" Outside Depth
 1/8" Wall Thickness
 Paper Insert
 1/8" Mounting Holes
 Downloadable Templates
 Additional Info: Not For Use Outdoors
 Additional 10-Pack Perforated Pages Available

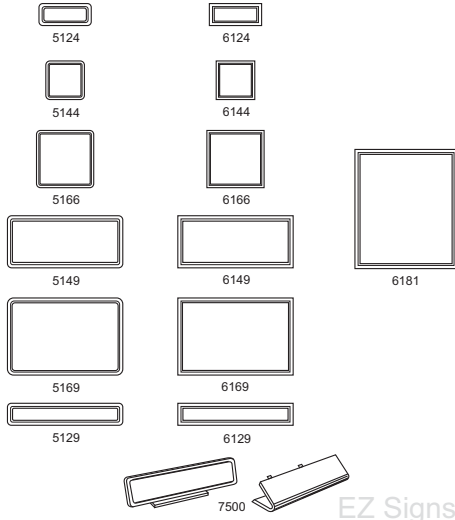

Inside Dimension	Square	Radius
1-3/4" x 4-1/8"	6124	5124
1-3/4" x 9-1/8"	6129	5129
4-1/8" x 4-1/8"	6144	5144
4-1/8" x 9-1/8"	6149	5149
6-1/8" x 6-1/8"	6166	5166
6-1/8" x 9-1/8"	6169	5169
8-1/2" x 11"	6181	

Radius frames have a 5/16" inside radius.

Each frame set includes: 1 frame with lens, 1 sheet of perforated paper, and a suction cup.

Templates can be downloaded from our website.

Optional: Desk Base

Use part number 7500 to turn 5129 & 6129 into a desk frame.



7500 Desk Base

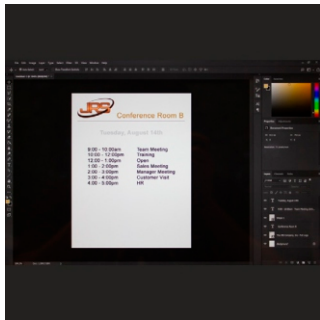

Create



Print Document



Place in Frame



Snap in Lens

Available Colors

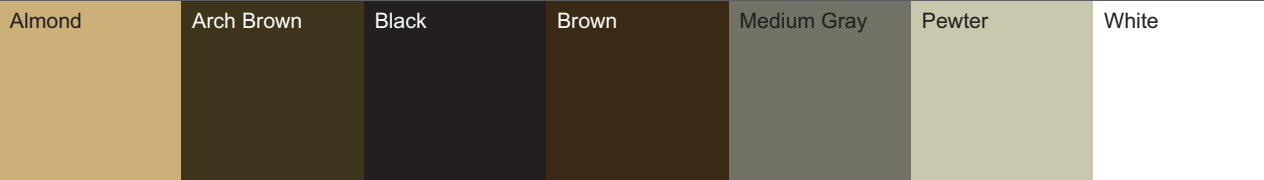

Colors portrayed are for reference only and are similar but not exact matches to the actual material colors. Contact us for samples to color match materials.

Designer Frames



PRODUCT DETAILS

- Material: Molded Plastic
 Features: 7 Color Options
 1/2" Outside Depth
 1/8" & 1/4" Wall Thickness
 Supports 1/16" & 1/8" Material
 1/8" Mounting Holes
- Additional Info: Corridor Frame Optional
 Lens Optional
 Not For Use Outdoors

Our Designer Frame System Frame System is designed for quality interior signage. Several unique features offered by this system will make designing and mounting interior signage simple! Available in square or radius corners.

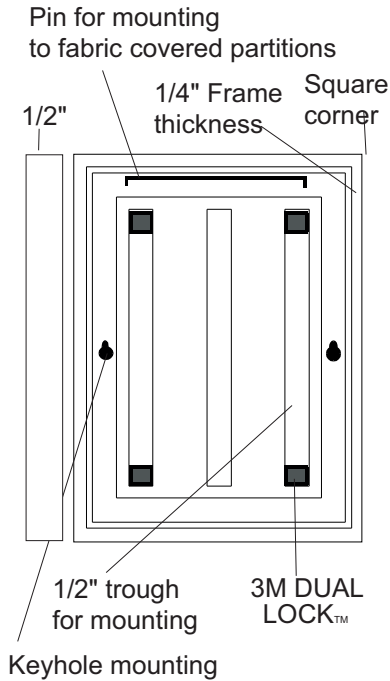

Designer Plastic Frame

Inside Dimension	Square Door/Wall	Radius Door/Wall	Square Corridor	Radius Corridor
1-7/8" x 3-7/8"	3124	9124		
1-7/8" x 7-7/8"	3128	9128		
1-7/8" x 9-7/8"	3120	9120	3220	9220
3-7/8" x 3-7/8"	3144	9144		
3-7/8" x 7-7/8"	3148	9148		
3-7/8" x 9-7/8"	3140			
3-7/8" x 11-7/8"		9142	3242	9242
5-7/8" x 5-7/8"	3166	9166	3266	9266
5-7/8" x 7-7/8"	3168			
5-7/8" x 11-7/8"		9162	3262	9262
7-7/8" x 7-7/8"	3188	9188	3288	9288
11-7/8" x 11-7/8"		9122	3222	9222

Radius frames have a 3/8" inside radius and a 1/8" wall thickness. Square frames have a 1/4" wall thickness.

Corridor frames come with a anodized matte black metal bracket.

Signage plates can be mounted with adhesive backed material or Dual-Lock™ so they are tamper resistant but still removable with a suction cup. For permanent signage use adhesive or two sided transfer tape.

Offers pin system that mounts into frame making easy hanging from fabric office partitions and cubicles. Wire pins sold separately.

Optional: Desk Base

Use part # 9000 to turn 9120, 9128, 3120, and 3128 into a desk frame.

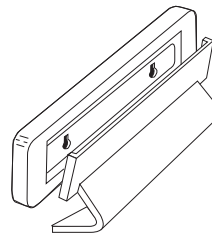

9000 Desk Base



Optional: Lens

Lenses are custom fabricated from an .060" thick Matte/Clear material.



Custom Lens



Designer Frames



Our Designer Frame System Frame System is designed for quality interior signage. Several unique features offered by this system will make designing and mounting interior signage simple!

PRODUCT DETAILS

Material: Molded Plastic
 Features: 7 Color Options
 1/2" Outside Depth
 1/8" & 1/4" Wall Thickness
 Supports 1/16" & 1/8" Material
 1/8" Mounting Holes
 Additional Info: Corridor Frame Optional
 Lens Optional
 Not For Use Outdoors



Corridor Bracket



Desk Frame



Key Hole & Wire Clip

Available Colors

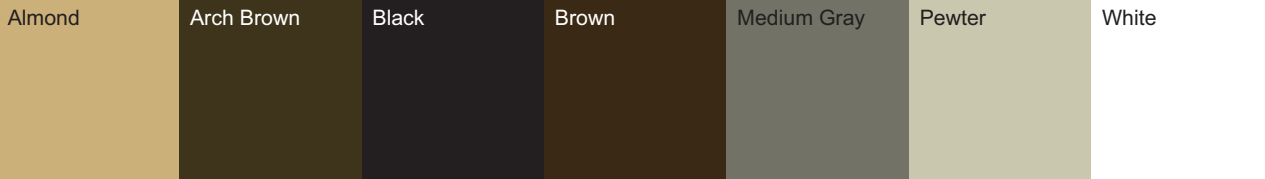

Designer Modular Frame Sections

Part Number	Section Height	Inside Length	Modular Section	Color
3112BL	2"	11-7/8"	End Section	Black Only
3113BL	2"	11-7/8"	Mid Section	Black Only

2" sections can be added together to increase the height of the frame. Sections fit together by rotating plastic tabs into plastic barrels that can be glued together or screwed together with a #2 lat head self tapping screw.

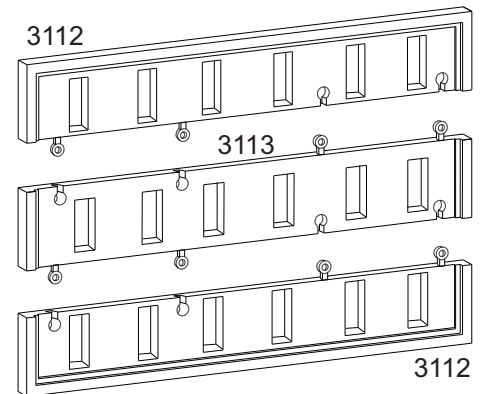

Designer Modular Frame

Colors portrayed are for reference only and are similar but not exact matches to the actual material colors. Contact us for samples to color match materials.

Architectural Plastic Frames



PRODUCT DETAILS

- Material: Molded Plastic
- Features: 7 Color Options
- 1/2" Outside Depth
- 1/8" Wall Thickness
- Supports 1/16" & 1/8" Material
- 1/8" Mounting Holes
- Additional Info: Corridor Frame Optional
- Lens Optional
- Not For Use Outdoors

Architectural Frames in Molded Plastic is a round and square corner system designed for quality interior signage. All frames have a 1/2" outside depth, 1/8" thick walls, and mounting holes for attaching to walls. Each frame is designed to accommodate all sign material from 1/16" to 1/8" thick. Frames with rounded corners have a 5/16" radius.



Architectural Plastic Frame

Inside Dimension	Square Door/Wall	Radius Door/Wall	Square Corridor	Radius Corridor	Square Desk Bar	Radius Desk Bar
1-3/4" x 4-1/8"	8124	7124				
1-3/4" x 9-1/8"	8129	7129	8329	7329	8029	7029
1-3/4" x 13-1/8"	8123	7123				
4-1/8" x 4-1/8"	8144	7144				
4-1/8" x 9-1/8"	8149	7149				
4-1/8" x 13-1/8"	8143	7143	8343	7343		
6-1/8" x 6-1/8"	8166	7166	8366	7366		
6-1/8" x 9-1/8"	8169	7169				
8-1/2" x 11"	8181					
9-1/8" x 9-1/8"	8199	7199	8399	7399		

Radius frames have a 5/16" inside radius.
 Corridor frames come with a anodized matte black metal bracket.
 Desk Bars feature a 1" thick frame

Optional: Lens

Lenses are custom fabricated from an .060" thick Matte/Clear material.



Custom Lens



Desk Bar



Corridor Bracket

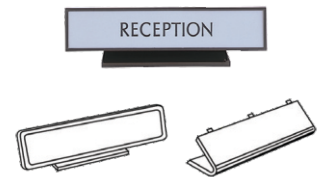

7500 Desk Base

Available Colors

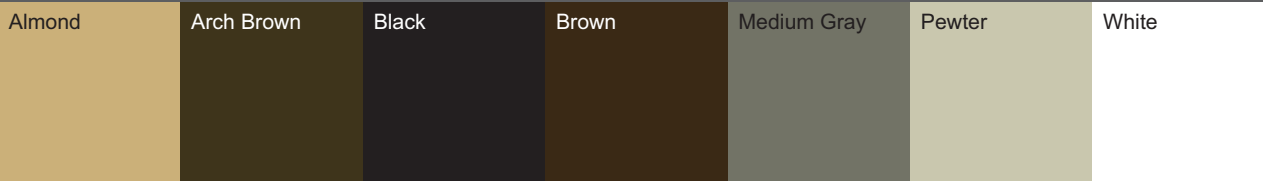

Colors portrayed are for reference only and are similar but not exact matches to the actual material colors. Contact us for samples to color match materials. Corridor frames are considered custom and not returnable.

Fixtures & Frame Supplies

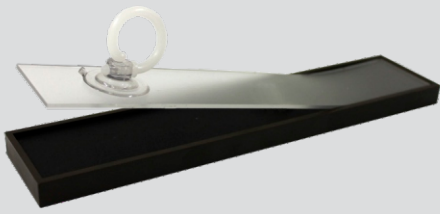

3M™ Dual-Lock™

Part Number	Name	Size	Applied Adhesive	Color
BO9400	Dense Dual-Lock™	1/2" x 12"	Yes	Black
BO9450	Wave Dual-Lock™	1/2" x 12"	Yes	Black



Adhesive backed 3M™ Wave Dual-Lock™ engages with 3M™ Dense Dual-Lock™ giving an audible snap to ensure positive locking. Dual-Lock™ is perfect for mounting signage into the JRS Designer frames and Premier Frames.

3M™ Dual-Lock™

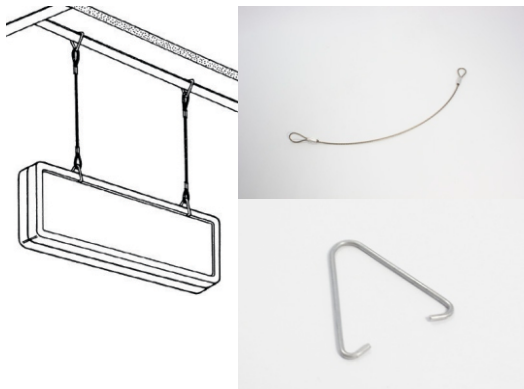

Looped End Cables & V-Clip

Looped End Cables & V-Clip

Part Number	Name	Standard Length	Wire Diameter	Loop Size	Maximum Weight
BO9310	V-Clip				25 Lbs.
BO9315	Looped End Cable	12"	1/16"	1"	30 Lbs.

JRS double-sided frames are easily suspended from T-bar ceilings by combining "V" clips and looped-ended cables.

Suction Cups

Part Number	Name	Diameter
BO9010	Suction Cup Hanger	1-3/4"
BO8000	Suction Cup	1-3/16"



Suction Cup with Hanger



Suction Cup with Removal Ring

BO9010 - Suction cup hanger has a metal hanger for hanging signs on windows and glass doors.

BO8000 - Sign panels and lenses can be easily inserted and removed using convenient suction cups with removal ring.

Prestige Stand-Ofs

Stand-Ofs create a rich inished layered look by raising your material of the surface. Our stand-ofs come in packages of four and are for use with 1/16" to 3/8" thick material. Material stud included, mounting screws not included.

PRODUCT DETAILS

Material: Aluminum
 Features: 3 Anodized Finishes
 1/2" & 3/4" Diameter Options
 Supports 1/16" to 3/8" Material
 3/4" & 1" Bar Height
 Additional Info: 4 Per Pack
 Not For Use Outdoors
 Screws Not Included



Prestige Stand-Ofs

Part Number	Diameter	Bar Height	Cap Height	Required Hole Size	Color
CA1319BL	1/2"	3/4"	5/32"	5/16"	Black
CA1319SS	1/2"	3/4"	5/32"	5/16"	Satin Silver
CA1319SYG	1/2"	3/4"	5/32"	5/16"	Satin Yellow Gold
CA1925BL	3/4"	1"	1/4"	3/8"	Black
CA1925SS	3/4"	1"	1/4"	3/8"	Satin Silver
CA1925SYG	3/4"	1"	1/4"	3/8"	Satin Yellow Gold



CA1319 stand-ofs will use a #6 screw for mounting, not included.

CA1925 stand-ofs will use a #8 screw for mounting, not included.

Prestige Stand-Ofs



Side View

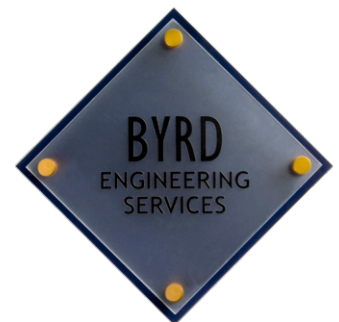

Need a custom size, American-Made stand-of? Contact us for details.

Colors portrayed are for reference only and are similar but not exact matches to the actual material colors. Contact us for samples to color match materials.

JRS carries multiple simple solutions for mounting on office cubicles and partitions.

Cubicle & Partition Mounts

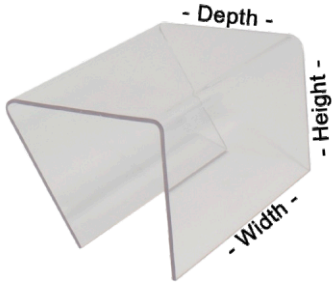

Clear Plastic Partition Hanger

Clear Plastic Partition Hanger

Part Number	Color	Depth	Height	Width
P110	Clear	2-1/8"	1-7/8"	3-1/2"

For mounting nameplates or signs over the top of office partitions. High strength adhesive or foam tape recommended for mounting to signage.

Custom acrylic sign holders and partition brackets are available in both 1/16" x 1/8" material. Please contact us for more information.

Partition Pins

Part Number	Color	Adhesive	Base Dimensions	Pin Length
JN4988	Clear	No	3/4" x 1"	1-5/8"
JN4985	Clear	Yes	3/4" x 1"	1-5/8"

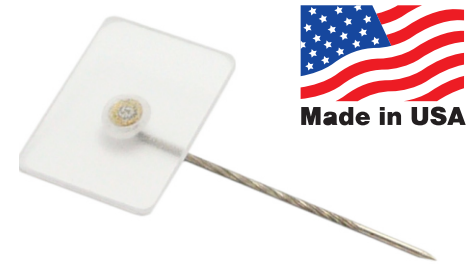

Partition Pin

Partition pins are applied to the back of signage to allow mounting to fabric office partitions.



3" Wire Clip

Wire Clips for Designer Frames

Part Number	Size
BO9100	6"
BO9200	3"

Wire clips have been designed to be used with the Designer series frames.

Insert wire clip through holes located at top of the frame. Work around bend in wire while gently applying pressure upwards. Snap wire in places between frame and small peg. Apply adhesive inside frame over wire to secure permanent wire placement.

MOUNTING

JRS stocks two popular types of adhesive one is a transfer tape, the other is a mounting tape. We also carry an engraving table mat for keeping engraving material in place.

Engraving Supplies

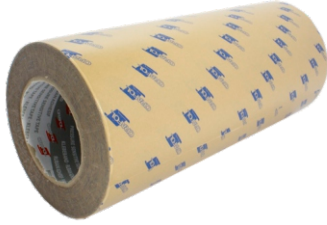
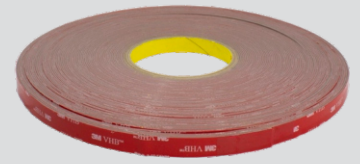

Transfer Tape

Orafol® Orabond® Transfer Tape

Part Number	Color	Size	Thickness	Adhesive Type
O1255	Clear	12" x 55yd	.002"	Acrylic

Orafol® Orabond® 1375 is perfect for bonding two sheets together and is recommended when applying ADA appliqué to a substrate.

This transfer tape consists of a highly transparent pure acrylate adhesive with an excellent resistance to ultraviolet radiation, extreme temperatures, chemicals, solvents and humidity. Its high shear transfer adhesive is extremely durable on metal, varnish and high energy surfaces.

3M™ VHB™ Mounting Tape

Part Number	Color	Size	Thickness	Adhesive Type
RP45	Gray	1/2" x 36yd	.045"	Acrylic

The 3M™ VHB™ RP45 mounting tape consists of a durable acrylic adhesive with viscoelastic properties. This provides an extraordinarily strong double sided foam tape that adheres to a broad range of substrates, including aluminum, stainless steel, galvanized steel, composites, plastics, acrylic, polycarbonate, ABS and painted or sealed wood and concrete.

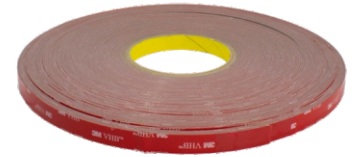

Mounting Tape



Engraving Table Hold Down Mat

Engraving Table Hold Down Mat

Part Number	Size	Color
SK2448	24" x 48"	White

Seklema table mat is a highly recommended tacky rubber mat used in engraving machines. Seklema is used to keep your engraving material held down flat and prevents movement during engraving, eliminating the need for table adhesives or vacuums. Seklema comes with a rigid plastic core and is double sided with a tacky rubber coating allowing the material to be lipped over for continued use.

Hook and Loop Fastener

Part Number	Style	Color	Size	Adhesive Type
H58BL	Hook	Black	5/8" x 25yd	Acrylic
L58BL	Loop	Black	5/8" x 25yd	Acrylic

Hook and loop fastener tape is perfect for items that need strong secure mount but will also allow for removal of signage. This tape can be applied to various surfaces and provides a strong bond. Hook and loop are pressed together to create the secure bond.



Hook and Loop Fastener

Colors portrayed are for reference only and are similar but not exact matches to the actual material colors. Contact us for samples to color match materials.

DuetsTactiles™ ADA & APPLIQUÉ



PRODUCT DETAILS

Material Type: Impact Modified Acrylic
 Usage: Outdoor/Indoor
 Finish: Matte (non-glare) Finish
 Thickness: 1/32" | 1/16" | 1/8"
 Ply: 1-Ply
 Sheet Size: 24" x 48" | 24" x 24" | 12" x 24"
 Options: Pre-Applied Adhesive Available for 1/32" Sheets
 Adhesive available for 1/16" & 1/8" Sheets (Upcharge)

ADA wayfinding is a vital segment of any sign making business, and DuetsTactiles products are the perfect solution. Choose from the broadest selection of modern colors to match any interior or exterior decor.



Thickness	Clear/Matte	Bright White	Frost	White	Warm White	Yellow	Metallic Gold	Orange	Medieval Copper	Pipestone	Red	Burgundy
1/32" *A A2	L-010-033*	L-010-303*	L-010-583*	L-010-113*	L-010-563*	L-010-143*	L-010-673*	L-010-623*	L-010-423*	L-010-533*	L-010-133*	L-010-543*
1/16"	L-010-036	L-010-306	L-010-586	L-010-116	L-010-566	L-010-146	L-010-676	L-010-626	L-010-426	L-010-536	L-010-136	L-010-546
1/8"	L-010-038	L-010-308	L-010-588	L-010-118	L-010-568	L-010-148	L-010-678	L-010-628	L-010-428	L-010-538	L-010-138	L-010-548



Thickness	Merlot	Pink	Light Blue	Periwinkle	Slate Blue	Blue	Cobalt Blue	Majestic Blue	Denim Blue	Spruce	Lagoon	Intense Teal
1/32" *A A2	L-010-523*	L-010-513*	L-010-373*	L-010-363*	L-010-493*	L-010-153*	L-010-573*	L-010-403*	L-010-353*	L-010-433*	L-010-463*	L-010-453*
1/16"	L-010-526	L-010-516	L-010-376	L-010-366	L-010-496	L-010-156	L-010-576	L-010-406	L-010-356	L-010-436	L-010-466	L-010-456
1/8"	L-010-528	L-010-518	L-010-378	L-010-368	L-010-498	L-010-158	L-010-578	L-010-408	L-010-358	L-010-438	L-010-468	L-010-458



Thickness	Mint	Spring Green	Evergreen	Bisque	Almond	Bone	Khaki	French Vanilla	Desert Sand	Putty	Latte	Taupe
1/32" *A A2	L-010-443*	L-010-173*	L-010-183*	L-010-323*	L-010-203*	L-010-313*	L-010-263*	L-010-343*	L-010-383*	L-010-603*	L-010-333*	L-010-393*
1/16"	L-010-446	L-010-176	L-010-186	L-010-326	L-010-206	L-010-316	L-010-266	L-010-346	L-010-386	L-010-606	L-010-336	L-010-396
1/8"	L-010-448	L-010-178	L-010-188	L-010-328	L-010-208	L-010-318	L-010-268	L-010-348	L-010-388	L-010-608	L-010-338	L-010-398



Thickness	Aged Bronze	Chestnut	Chocolate Brown	Light Grey	Grey	Silver	Oyster Shell	River Clay	Frosted Plum	Charcoal Grey	Graphite	Black
1/32" *A A2	L-010-593*	L-010-613*	L-010-163*	L-010-473*	L-010-653*	L-010-193*	L-010-483*	L-010-503*	L-010-413*	L-010-293*	L-010-553*	L-010-103*
1/16"	L-010-596	L-010-616	L-010-166	L-010-476	L-010-656	L-010-196	L-010-486	L-010-506	L-010-416	L-010-296	L-010-556	L-010-106
1/8"	L-010-598	L-010-618	L-010-168	L-010-478	L-010-658	L-010-198	L-010-488	L-010-508	L-010-418	L-010-298	L-010-558	L-010-108

Colors portrayed are for reference only and are similar but not exact matches to the actual material colors. Contact us for samples to color match materials. Sheet sizes are approximate.
 *-A - Indicates item with 3M™-467MP adhesive backing
 *-A2 - Indicates item with Orafol™ 1375 adhesive backing

ADA Supplies

JRS carries a variety of braille balls and braille dot drills for creating quality ADA signage.



Braille Balls

ADA Braille Balls

Part Number	Color	Size	Package Qty	Material
AB-BLACK	Black	.059"	11,000	Acrylic
AB-CLEAR	Clear	.059"	11,000	Acrylic
AB-GRAY	Gray	.059"	11,000	Acrylic
AB-WHITE	White	.059"	11,000	Acrylic
MB-STAINLESS	Stainless Steel	.059"	1,000	Stainless Steel

Produce high quality ADA-compliant signage with our ADA Braille Balls. Beads can be applied to any material which has been drilled for braille beads or raster beads.

Braille Dot Drill

Part Number	Name	Shank Diameter	Length	Material
EZH171	EZ Bit Holder	11/64"	6"	Stainless Steel
EZH250	EZ Bit Holder	1/4"	6"	Stainless Steel
EZBD171	Braille Dot Drill Insert	11/64"	1"	Solid Carbide
EZBD250	Braille Dot Drill Insert	1/4"	1"	Solid Carbide

EZ Bit holders are the quick solution to replacing damaged or worn engraving cutters at a significant cost savings to you. You can easily replace the cutter tip without the need to remove the cutter shaft or knob. Includes allen wrench.

EZ Bit Braille Dot Drill Inserts are used for creating ADA braille holes needed for ADA braille beads. For use with the EZ Bit Holders.



EZ Bit Holder and Dot Drill Insert



The Hitt Companies, Inc. Divisions



HITT Marking Devices
www.HittMarking.com



Rubber Stamps R Us
www.RubberStampsRus.com



National Stencil and Sign
www.NationalStencil.com

3231 W. MacArthur Blvd. - Santa Ana, CA 92704 - Ph. 714-979-1405