

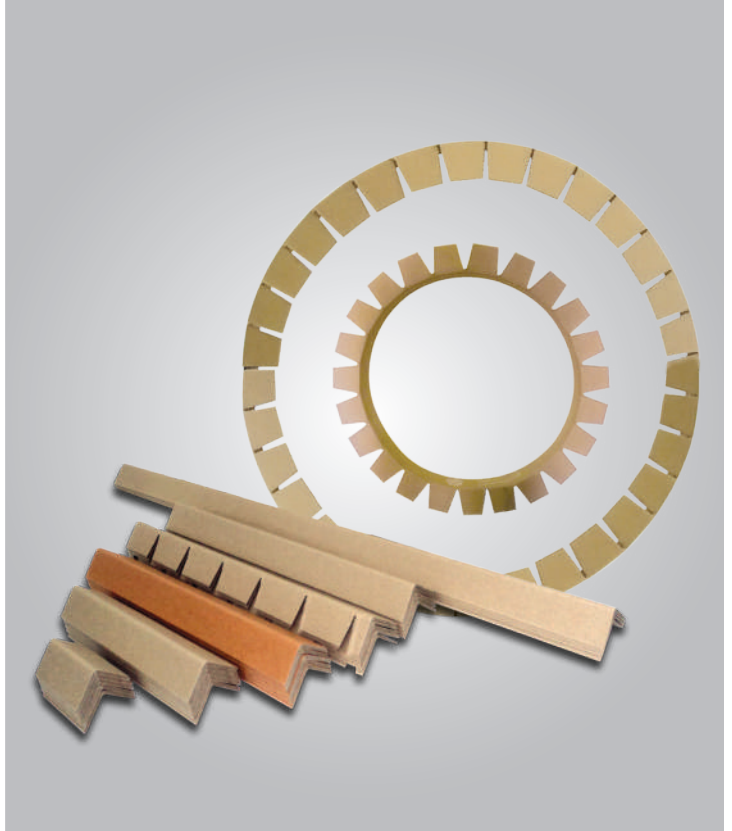

شركة الفصول للتجارة والصناعة الدولية  
SEASON INTERNATIONAL TRADING & INDUSTRIES CO.



**TOTAL PACKAGING SOLUTION**





## About Us:

**Season International Trading & Industries Co. (SITCO)** was established in August 2000. **SITCO** joined Almoayed International Group in 2002.

**SITCO** specializes in providing industrial packaging materials & supplier equipment, baling & compacting machines and transport-securing solutions by means of strapping with manual systems as well as full automated strapping mechanisms.

At **SITCO** our customer satisfaction is always our prominent goal where we continuously aim to exceed our customer's expectations via innovation.

The customers experience is thought through from the pre-sales phase and it is followed through with the highest level of after sales services. Our highly qualified maintenance and service engineers have been extensively trained locally and internationally to handle all your installation or maintenance requirements around the clock.

Our services extend from the Kingdom of Bahrain and throughout the Kingdom of Saudi Arabia, while reaching to the Sultanate of Oman; making **SITCO** a prominently unique trading company in its various sectors of operation.

With over eighteen years of experience and a team of dedicated professionals, **SITCO** has managed to comprehend the ever-changing market demands. Our team of specialists strives to fulfill varied requirements of our clients by providing them with complete end-to-end solutions that go beyond the basic product requirements.

## نبذة عن الشركة :

تأسست شركة الفصول للتجارة و الصناعة الدولية ( سبتكو ) في شهر أغسطس من عام ٢٠٠٠ م وانضمت لمجموعة المؤيد العالمية في عام ٢٠٠٢ م .

سبتكو، شركة متخصصة في توفير مواد التغليف للأغراض الصناعية إضافة على ما توفره من مستلزمات للموردين، و معدات وأدوات التغليف الآمن والرص أو الترزيم بالضغط، و هي متخصصة في تقديم حلول النقل الآمن من خلال الربط بين الأنظمة اليدوية، و آليات الربط الآلي الكاملة.

نحن في سبتكو معنيون بتحقيق أقصى حالات الرضا لكافة عملائنا، وهذا هو أبرز أهدافنا حيث أننا نتطلع إلى تجاوز توقعات عملائنا عبر الابتكار على الدوام .

نضع رغبات عملائنا، واحتياجاتهم على رأس أولوياتنا، و نوليها جَل اهتمامنا بدءاً من مرحلة ما قبل البيع مشفوعاً بأعلى مستوى من خدمات ما بعد البيع. ولأجل الوفاء بهذا الإلتزام فقد تم إخضاع مهندسي الصيانة، والخدمة من ذوي الأهلية العالية العاملين لدينا لبرامج تدريب محلية، و دولية لتمكينهم من التعامل مع جميع متطلبات الصيانة على مدار الساعة.

خدماتنا تمتد عبر مملكة البحرين وتشمل جميع أنحاء المملكة العربية السعودية، وصولاً إلى سلطنة عمان. الأمر الذي يجعلنا نقدم خدمات فريدة من نوعها بشكل بارز في مختلف قطاعات عملنا.







وبفضل خبرة تراكمية تزيد عن ثمانية عشر عاماً، وفريق من المهنيين المتفانين، تمكنت الشركة من فهم مطالب واحتياجات السوق المتغيرة باستمرار. لذا يسعى فريقنا من ذوي الاختصاص جاهداً لتلبية كافة احتياجات عملائنا مع تنوعها من خلال تزويدهم بحلول متكاملة من البداية إلى النهاية تتجاوز متطلبات المنتج الأساسية.

# ADHESIVE TAPES

SITCO is the manufacturer and distributor of the best & the most reliable brand of adhesive tapes in the GCC & the Middle East Region

With wide selection of Adhesive products to choose from, SITCO provides best solution for Home, Office & Industrial demands

## Advanced Features

- |  |  |
|--|--|
| <b>1</b>  Printing  | <b>4</b>  Bubble-Free |
| <b>2</b>  Low VOC   | <b>5</b>  Easy-Tear   |
| <b>3</b>  Low-Noise | <b>6</b>  Super Clear |

## OPP TAPES

OPP Adhesive Tapes are made of bi-axially oriented polypropylene (BOPP) film coated with acrylic emulsion adhesive

### Acrylic Emulsion Adhesive Tapes

- Transparent
- Carton sealing purpose

### Solvent Rubber OPP Tape

- Manual Carton Sealing
- Recommend for automatic carton sealing machine use
- Adhesive on uneven surfaces due to excellent power
- Refrigeration use suitable (Application at room temperature above 10°C)
- Temperature resistance after application
- Suitable for use on most types of recyclable cartons, due to special adhesive compound

### Hybrid Adhesive Strong Bond Tape

- Best alternative to solvent rubber OPP Tape
- Bond well to corrugated box & Plastic materials
- Temperature resistant to extreme heat and cold environment



### Crystal Clear OPP

- Crystal clear, Stick better
- Carton Sealing

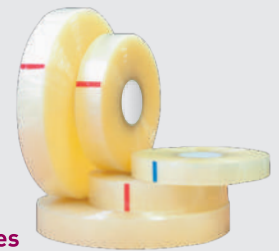

### BOPP Tapes

- Recommended for Automatic carton sealing machine use
- Sealing & General packing use

## MASKING TAPES

These Masking Tapes are resin impregnated crepe paper coated with latex rubber adhesive with high stable adhesion and superior heat resistant.

The tapes are 100% disposable and environmental friendly

### Masking Tapes

- Economical grade
- Light duty masking, bundling, holding, splicing & labelling for home, school & industry.

### Auto Grade Masking Tapes

- Industrial Grade
- Residential construction, carpet fixing, splicing, bundling, tabbing & non-critical painting application.



### Painter Masking Tapes

- For professional painting job



## INDUSTRIAL TAPES



### Cloth Duct Tape

Cloth duct tape is based on a tearable fabric and a natural rubber adhesive in synthetic rubber adhesive. It is a very strong often used for carpet, packaging, especially waterproof requirement. Different colours are available

- For carton sealed, carpet seamed, pipeline wrapping, connections, waterproof, binding and sealing
- Permanent interior and exterior hole covering.



### Brown Tape

- Acrylic Emulsion Adhesive
- Carton Sealing Purpose
- Light brown and Dark brown available

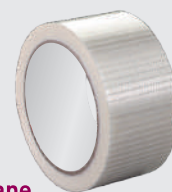

### Cross Filament Tape

This tape is made of an electrical grade polyester film backing reinforced with scrim glass filaments and coated with a thermosetting rubber pressure sensitive adhesive

- provides excellent tensile strength, edge tear resistance and electrical characteristics
- Designed for insulation in dry-type transformers, motor winding and end-turn wire-hold applications and more



### Aluminium Foil Tape

- Air Conditioning ducting
- Duct sealing & joining for refrigerator & excellent barrier to vapour
- Roofing application: Flashing joints & insulation

# ADHESIVE TAPES

## Double Sided Tapes

Double sided tapes are light-weight PP film or tissue paper coated with strong adhesive on both sides separated by release liner

### DOUBLE SIDED TISSUE TAPE ACRYLIC SOLVENT ADHESIVE

Double sided tissue tape is coated with strong acrylic adhesive on both sides of non-woven tissue carrier. It bonds well to most surfaces & materials for splicing applications

- Excellent durability and widely adhesion to many surfaces
- For bonding all kinds of rubbers, foam & fabrics
- Applied by hand or with laminating equipment



### DOUBLE SIDED TISSUE TAPE HOT MELT ADHESIVE

Double sided tissue tape is coated with strong acrylic adhesive on both sides of non-woven tissue carrier.

- For punching, Name plates bonding and film switches fixing
- For evaporator in refrigerator, symbols, badges & bonding between foam and rubber
- For household electronic appliances and electronic apparatus



### DOUBLE SIDED ACRYLIC FOAM TAPE

Double sided acrylic foam adhesive tape coated with high tack acrylic adhesive on both sides.

- For bonding all kinds of substrates, e.g. many metal, plastic & painted materials
- Join material & replace mechanical fasteners.
- For many interior & exterior industry applications.



### DOUBLE SIDED POLYETHYLENE FOAM TAPE

Coated with high tack acrylic adhesive on both sides. PE paper liner and PE film liner for different demands.

- For furniture, mirror, functional trims & decorative panels etc.
- Excellent dimensional stability for die-cutting.



### DOUBLE SIDED POLYESTER FILM TAPE

Double sided high temperature Polyester tape has excellent bonding and very aggressive adhesion and provides reliable sticking effect even though under rigorous outside force & temperature.

- Suitable for kinds of name plates & film switches mounting & fixing
- For dimensional stability & improved handling with ease of die cutting and laminating.
- Adhesion to plastic & Foam, attach gaskets and LED lens on cellular phones and pagers



## INDUSTRIAL TAPES

Industrial tapes are versatile and are used on wide variety of purpose from ducting, sealing, markings & framing.

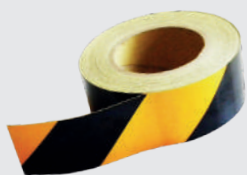

### Line Tapes

- Hazard Tapes (2 coloured tapes)
- For identifying or marking hazards & dangerous areas

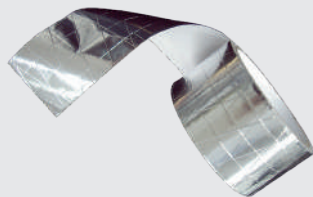

### Reinforced Aluminium Tapes

- Aluminium foil reinforced with non-woven, puncture resistant, tear resistant, acrylic adhesive, 5.0 mil backing thickness



### Kraft Tapes

- Sealing & General packing use
- Best for cold or humid conditions
- Silk screening or picture framing



### PVC Black Pipe Wrapping Tape

- PVC tape helps prevent corrosion and can be used with metal pipe or conduit in pressure-sensitive applications

## CORDSTRAP POLYESTER STRAPPING

Cordstrap polyester strapping is specifically designed for quick and easy bundling, unitizing and palletizing of a wide variety of cargo.

Cordstrap polyester strapping solutions provide safe and cost-effective ways to secure cargo and prevent transport damage.

Cordstrap polyester strapping has many advantages over conventional, manually applied strapping products such as plastic strapping (Polypropylene, Extruded Polyester & PET), steel strapping and metal banding.

### Benefits of cordstrap polyester strapping



AS STRONG AS STEEL



SAFE FOR USER & RECEIVER



PREVENTS PRODUCT DAMAGE



EASY TO USE

## COMPOSITE STRAPPING AND BUCKLES

Known as 'synthetic steel', Cordstrap composite (CC) strapping is the latest development in strapping technology. Manufactured from high tenacity polyester yarns embedded in a polymer coating, CC strapping is available in a wide variety of widths and strengths.

### Benefits :

- Strength of up to 1800 daN / 4050 lbf
- Re-tensionable
- Non abrasive – will not damage products in transit
- Germanischer Lloyd certified
- Available Width 13mm - 32mm



## CORDSTRAP BUCKLES

Cordstrap strapping buckles provide the strongest and most consistent joint in the industry.

### Benefits :

- Most consistent closure method in the industry
- Joint efficiency of up to 90%
- Manufactured from high quality steel wire
- Self locking
- Available in different sizes and strengths



## STRAPPING DISPENSERS

The dispensers can be used with all Cordstrap Composite Strapping products.

### Benefits :

- Available in mobile and static versions
- Strap can be placed on the dispenser easily and quickly
- Highly durable
- Ergonomic design



## PALLET NEEDLE

Suitable for strap widths: 13 mm - 40 mm / 1.2" - 1.58"

### Benefits :

- Quicker and easier strapping of cargo on pallets
- Strap can be easily fed under pallet
- Easy to work with light weight

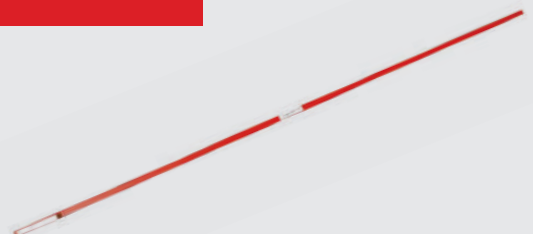

## Cordstrap Tensioners

Cordstrap is polyester composite strapping and buckle solutions provide a high quality, strong solution to securing products. They are easy to use and can be consistently applied with our high-quality, low-maintenance tensioner tool range.

### MANUAL STRAPPING TENSIONERS

Our manual tensioners allows tension to be applied to a cargo securing system in an easy, fast and ergonomic manner, with the highest pre-tension in the market.

#### Benefits :

- High quality steel body
- High durability
- Light weight
- Highest pre-tension in the market
- Hardened steel parts
- Low initial cost
- Easy to use



### CBT 35 BATTERY OPERATED TENSIONER

Ergonomically designed to be easy to handle, powerful and reliable, the CBT 35 Battery Operated Tensioner combined with Cordstrap composite polyester strapping is the perfect answer to your cargo strapping requirements.

#### Benefits :

- Strong tension force-up to 800 daN
- Lightweight with ergonomic one-handed design
- Adjustable tension force and larger power button
- Available in different sizes and strengths
- Powerful
- Reliable
- Easy to use



### PNEUMATIC TENSIONER

Pneumatic strapping tools allow an extreme amount of tension to be applied to a strap with minimal effort.

#### Benefits :

- Push button operation
- Highest pre-tension in the market
- Conforms to CE standard
- Ergonomic design
- Light weight



## CORDSTRAP EDGE PROTECTORS

### CORDSTRAP CARGO EDGE PROTECTORS

Cordstrap cargo edge protection products protect shipped goods and are an integral part of bundling and palletizing cargo.

The right edge protection product depends on variables such as the application and type of polyester strap or lash used.

Your local Cordstrap Cargo Securing Specialist will be happy to advise you on the correct edge protection product for your needs.

#### Benefits :

- Fast and easy to apply
- Cost effective
- Protects both cargo and strap from damage to ensure optimal security
- Available in a wide variety of types, sizes and material including cardboard and plastic



# CORDSTRAP



## Cordstrap Lashing

Cordstrap lashing is the most effective way to secure cargo for international shipping wherever it may be, on any transport unit—containers, flat racks, railcars or ships. Cordstrap lashing eliminates incidents and damage to your cargo.

Safe, cost-effective and time-efficient, Cordstrap is AAR approved and GL certified polyester lashing solutions will safely secure cargo—whatever the conditions, whatever the application, in a CTU compliant manner.

Cordstrap is now introducing breakthrough new solutions specifically designed to secure both heavy and light loads in containers as easily and effectively as possible.

## COMPOSITE LASHING

Known as 'synthetic steel', Cordstrap composite (CC) lashing is the latest development in lashing technology. Manufactured from high tenacity polyester yarns embedded in a polymer coating, CC lashing is available in a wide variety of widths and strengths.



## CORDLASH WOVEN LASHING

Cordlash polyester lashing solutions have many advantages over conventional lashing products. They are safe, cost- and time-effective and easy to apply & eliminate cargo damage.

### Features :

- System breaking strengths of up to 20 tons
- Dynamic Cargo Securing Solutions keep cargo still, even when it is on the move
- Modular solutions for safe, cost-effective shipping
- Comprehensive range of accessories for tailor-made solutions



## CORDSTRAP LASHING BUCKLE

Cordstrap lashing buckles are manufactured from high quality steel and are available in different sizes and strengths. They can be used with Cordlash composite and woven lashing.

### Benefits :

- Joint efficiencies of up to 90%
- Non lip
- Tensioned with easy to use Cordstrap tooling
- All lash/buckle combinations individually tested and certified by Germanischer Lloyd



## DESICCANTS

### Benefits of Cordstrap Desiccants include:

- Provide over 40 days of moisture control and protection
- Protect containerized cargo from moisture damage
- Non drip, even when completely saturated
- Easy to apply and safe to use
- Absorption Capacity : 200% - 250% (w/w)
- Test Conditions : 30° C and 80% RH
- Compliant with : EU Directive 2009/251/EC



## ANTI-SLIP MATS

### Benefits of Cordstrap Anti-slip Mats include:

- Enable quicker, easier and faster cargo securing
- Friction coefficient of minimum 0.8 $\mu$
- Conform to latest EN and DIN standards
- Manufactured from 100% recyclable materials
- Quick and easy to apply



## DUNNAGE BAGS

Superior dunnage bags, manufactured by Cordstrap

### BENEFITS OF CORDSTRAP DUNNAGE BAGS



COST-EFFECTIVE

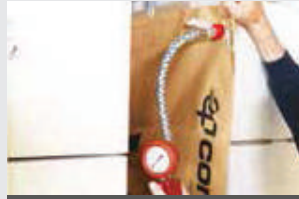

FAST TO APPLY



PREVENTS DAMAGE



USER-FRIENDLY



MOISTURE RESISTANT



SAFE FOR USER & RECEIVER



TESTED AND CERTIFIED



PUNCTURE RESISTANCE

## POLYPROPYLENE PAPER LAMINATED BAGS

Benefits of Polypropylene Paper Laminated Dunnage Bags include:

- Good level of puncture resistance
- Good level of moisture resistance
- Quicker and easier securing in containers, railcars and ships – ease of use
- AAR Approved
- Equipped with standard valve



## CONTAINER CARGO SECURING

### CORDSTRAP CORNERLASH

Secure up to 30 tons in a container

- CornerLash is an innovation that secures heavy loads (up to 30 tons) in containers as easily and effectively as possible.
- Whether securing drums, IBC's or for instance carton boxes or bags in 20ft. or 40 ft. containers, the CornerLash solution ensures cargo is secured in the safest and most efficient way possible.

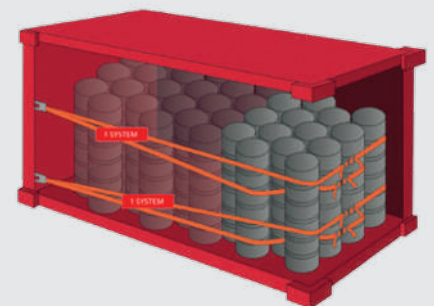

### CORDSTRAP ANCHORLASH

Secure up to 11 tons in a container

- AnchorLash has been specifically designed to secure light loads (up to 11 tons) in containers as easily and effectively as possible.
- Suitable for many types of light loads, including carton boxes, plastic drums, cans and other soft packaging – in both 20 ft and 40 ft containers – the AnchorLash solution ensures cargo is secured in the safest and most efficient way possible.

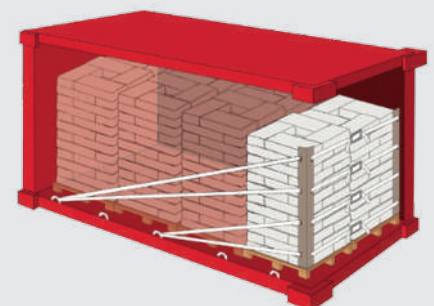



## DISPOSABLE ITEMS

### COCKTAIL NAPKIN

- 23cm X 23cm
- 2 Ply, 50 Sheets per pack
- Packing 36 Packs X 50 Sheets or Packing 50 Sheets X 20 packs
- Quality : made from 100% virgin pulp

### TABLE NAPKIN

- 33cm X 33cm
- 2 Ply, 50 Sheets per pack
- Packing 50 sheets X 40 packs
- Quality : made from 100% virgin pulp

### DINNER NAPKIN

- 40cm x 40cm
- 2 Ply, 50 Sheets per pack
- Packing 50 Sheets X 36 Packs



### FACIAL TISSUE

- 2 Ply X 100 Sheets per box
- Size : 190mm X 180mm
- Packing : 36 Box per carton



### INTER FOLD HAND TOWEL

- 1 Ply, 150 Sheets per packet
- Size : 250mm X 200mm or 200mm X 225mm
- Packing : 1 X 24 packets



### TOWELLING /MAXI ROLLS

- Size : 19cm X 300 m
- 2 Ply /1 Ply X 1kg (1000 grams per roll)
- Packing 1 X 6 rolls per carton



### TOILET ROLL - PLAIN/EMBOSSED

- 2 Ply X 300 Sheets
- 100mm X 105mm (width)
- 10 Rolls X 10 Bundles
- 2 Ply X 250 Sheets
- Packing 4 Rolls X 12 Pcs



### AUTO CUT ROLLS

- 1 Ply, 38 GSM
- 17cm Diameter, 20 cm height
- Weight per roll : 1.2 Kgs
- Packing : 6 Rolls per bundle



### CLINICAL ROLLS (DISPOSABLE HOSPITAL PAPER BED ROLL)

- 2 Ply, 50cm X 40m Pkg per roll
- Packing 1 X 12 Rolls



## MAXI ROLL DISPENSER



## AUTOCUT DISPENSER



## INTERFOLD HAND TOWEL DISPENSER

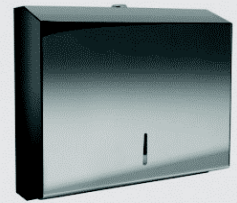

## CONE CUP & CONE CUP DISPENSER



## 7.OZ PAPER CUP WITH HANDLE



## PORTION CUPS



## NON WOVEN WIPES

- Size : 279mm x 330mm
- Color : Green
- Size : 85 pcs x 20 pkts
- Size : 43cm x 43cm
- Color : Blue, Green, Pink & Yellow
- Packing : 25 pcs x 16 pkts



## SALAD CONTAINER 1800CC

- Material : Polyethylene Terephthalate (PET)
- Color : Transparent
- Odour : Odourless
- Size : 22.8 X 17.8 X 9cm
- Packing : 50 Pcs per Pack X 4 Packs per Ctn
- 200 Pcs per Ctn



## PET FRUIT CONTAINER

- Container volume 250 GR
- Length : 12.50cm/4.92in
- Width : 9.50cm / 3.74in
- Height : 7.50cm / 2.95in
- Box Per Tube 110
- Tubes per Case 9
- 990 Pcs per Box

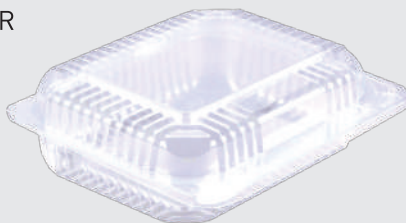

## SINGLE BLACK COMPARTMENT

- Clear Lid
- Material : PP/OPS
- Size : 238mm X 203mm X 38 mm
- Qty : 250 Pcs per Ctn



## DOUBLE COMPARTMENT

- Clear Lid
- Size : 238mm X 203mm X 38 mm
- Qty : 250 Pcs per Ctn



## PAPER HANDLE BAG

- Paper Handle Bag 40 X 28 X 15
- Brown Kraft - Large
- Paper Block Bottom Bag 31 X 15.5 X 10
- Brown Kraft - Medium
- Paper Block Bottom Bag 24.5 X 12.5 X 7.5
- Brown Kraft - Small
- Other printed & Plain Bags



## ZIPPER SANDWICH BAG

- 50 Bags X 24 Pkts Per Ctn



## CUTLERY

	Pcs / Bag	Pcs / Box
Disposable Fork	50 / 20	1000
Disposable Knife	50 / 20	1000
Disposable Spoon	50 / 20	1000



## FLEXIBLE STRAW

- 500 Pcs x 20 Pkts
- 6mm or 7 mm x 240 mm
- 630 x 430 x 530 mm



## FLEXIBLE STRAW BLACK INDIVIDUALLY PAPER WRAPPED

- Length : 17.5cm
- Inner Dia - 3mm
- 1000 Pcs Per Ctn



## PAPER WRAPPED TOOTH PICK

- 1000 Pcs x 12 Pkts
- 340 x 195 x 190 mm



## WOODEN COFFEE STIRRER

- Size : 19mm X 6mm X 1.5mm
- Packing : 1000 pcs X 14 Bags



## VINYL POWDERED GLOVES

- 230mm, Smooth/Embossed Inside, Clear, No Flavour Non Sterile (FG/SFG), Gnrl formulation
- Carton Size : 345x258x235mm
- Inner : 225x125x65mm
- Available Sizes : Small, Medium, Large & XL

## VINYL POWDER FREE POLYMER GLOVES

- 230mm, Smooth/Embossed inside, Clear, No Flavour Non Sterile (FG/SFG), Gnrl Formulation
- Packing : 100 Pcs/Inner X 10 Inners per Ctn
- Carton Size : 345x258x235mm
- Inner : 225x125x65mm
- Available Sizes : Small, Medium, Large & XL



## LATEX GLOVES

- Latex Powder Free Online Single Chlorinated Glove
- 240mm, Palm Textured/Embossed Outside, Natural No Flavour
- Non Sterile (FG/SFG), Gnrl Formulation
- Packing : 100 Pcs/Inner, 10 Inners Per Ctn
- Carton : 360 X 245 X 210mm
- Inner : 200 X 120 X 170mm
- Available Sizes in Powdered & Powder Free Small, Medium & Large



## THERMOPLASTIC ELASTOMER GLOVES (NON-STERILE)



- TPE (thermoplastic elastomer), powder free, non sterile
- favorable alternative to vinyl gloves
- excellent fit on hand and fingertips
- very soft and skin friendly
- good tactile sensation
- especially appropriate for contact with greasy and oily food

## HDPE GLOVES



## MOP CAP 18"

- Available Color : White, Blue & Black



## PE OVERSLEEVES

- Material : PE
- Machine Made
- Size : 20cm W X 40cm L; tolerance 1cm
- Color - Blue
- Weight : 2.5 gram Per Piece
- Packing : 10/Pieces/roll, 100 Pieces/Bag 2000 Pieces (1000 Pairs)/Carton



## CPE SHOE COVER

### 3 Grams

- Machine Made.
- 3 grams/Piece
- Color : Blue
- Size : 15cm X 39cm
- Packing 10pcs Per Roll, 100 Pcs Per Bag, 2000 Pcs per Ctn

### 6 Grams

- Material : CPE
- Manual Made, Color - Blue
- Size : 15cm Height X 40 cm of Length
- Weight : 6 Gram Per Piece,
- Tolerance : 0.5 gram
- Packing : 10 Pieces/Roll, 100 Pieces/Bag, 2000 Pcs/Ctn



## DISPOSABLE COVERALLS WHITE

- Durable & breathable fabric.
- Over 99% Protects from particles larger than 1 Micron
- Triple Stitched Seams protect against tearing.
- Silicon Free
- Elastic Wrist & Ankles
- Generous sizing with extended zip for increased comfort.

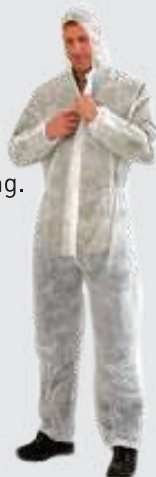

## BEARD NET

- 1000 Pcs/Ctn
- Single Elastic
- 14 Gsm



# EDGE PROTECTION SOLUTION



شركة سيزن ليد ادج للصناعات الورقية ذ.م.م.  
SEASON LEAD EDGE PAPER INDUSTRIES CO. W.L.L

## Cornerboard is an Excellent Product for Package Protection

Damage caused during transport and handling is a problem for manufacturers and distributors. This is why a number of producers and packaging experts have chosen Cornerboard protection as a solution.

## ECONOMY AND COST SAVINGS

By using Cornerboard, we aim to offer the customer a measurable advantage.



## FLEXIBLE PROTECTION

Specifically designed for product protection of different shapes. Provides safety and prevents damages during storage or transit.

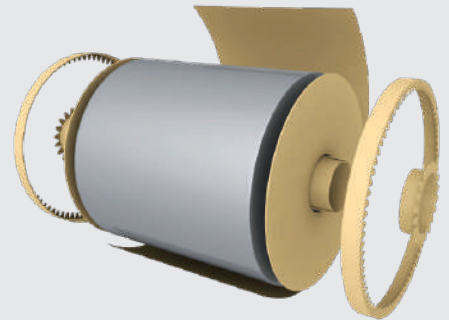

## RAW MATERIAL

The standard Cornerboard is manufactured by laminating several layers of strong paperboard into a rigid right angle. Our packaging solution with Cornerboard

- Replaces expensive packaging material
- Saves work and material
- Is environmentally friendly
- Is suitable for food packaging and can be sent all over the world without any need of extra treatment, such as the fumigation required for wooden material
- Allows optimise transportation space by multiple - stacking
- Strengthens package and minimizes transport damage

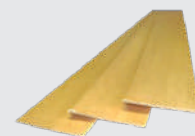

# EDGE PROTECTION SOLUTION



شركة سيزن ليد ادج للصناعات الورقية ذ.م.م  
SEASON LEAD EDGE PAPER INDUSTRIES CO. W.L.L

## PALLETIZATION & VERTICAL PROTECTION

Cornerboard stabilises the pallets and provides protection during transport and warehousing.

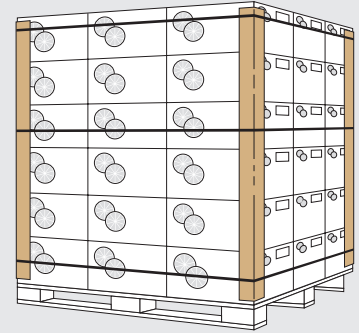

## STRENGTHENING PACKAGING UNITS

The strength of a single package can be improved by reinforcing boxes internally with Cornerboard.



## STACKING STRENGTH

Choosing the right Cornerboard for strengthening units will enable you to optimise space by multiple stacking.



## STRAPPING PROTECTION

Protecting edge against strapping damage.

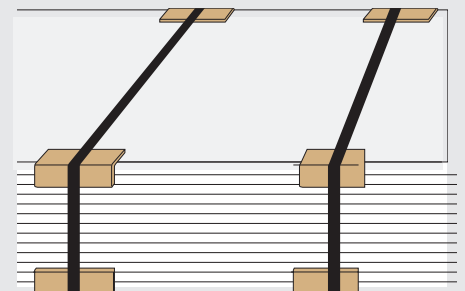

## WRAP-AROUND CORNERBOARD

The flexible wrap-around Corner Board is easy to use for inside or outside protection of reels/rolls.



# EDGE PROTECTION SOLUTION



شركة سيزن ليد ادج للصناعات الورقية ذ.م.م  
SEASON LEAD EDGE PAPER INDUSTRIES CO. W.L.L

## CORNERBOARD SIZES

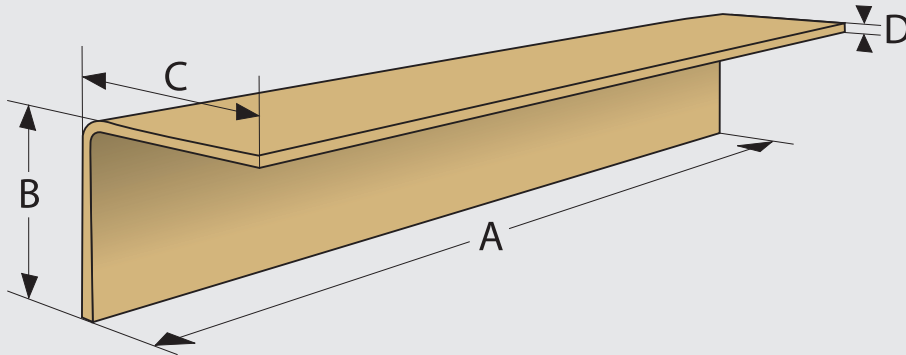

- A. CB Length
- B. Leg Length
- C. Leg Length
- D. Thickness

### Qualities

Corner Board can be delivered in a variety of surfaces are available in brown, white color & golden yellow or printed.

### Cold Lamination (Bio)

Laminated with a glue under high pressure. The selected raw materials are all of high quality and 100% recyclable. An excellent protection against moisture and dampness. Made of high quality recycled kraft board which is cold laminated at high pressure to form a profile element, that offers superb stability even when there are major fluctuations in moisture levels. Environmentally- friendly and recyclable.

### Options

- Self-adhesive Peel & Stick Corner Boards
- Wrap-around Corner Boards for round objects
- Corner boards with soft foam

### Printing

Company names, logos and advertisements can easily be printed during the manufacturing process.

### Standard Dimensions

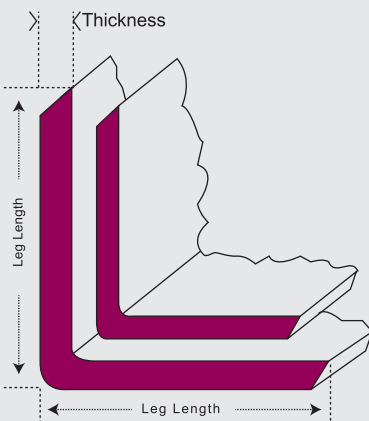

### Thickness

2.0 mm
2.5 mm
3.0 mm
3.5 mm
4.0 mm
4.5 mm
5.0 mm
6.0 mm
7.0 mm
8.0 mm

### Leg Length

30 x 30 mm
35 x 35 mm
40 x 40 mm
45 x 45 mm
60 x 60 mm
75 x 75 mm
85 x 85 mm

### Length

CornerBoard Length will be as per Customer requirement.



Special Products : Unequal leg lengths  
Printed CornerBoard & Poly coated CornerBoard  
Quick Stick CornerBoard

# EDGE PROTECTION SOLUTION



شركة سيزن ليد ايج للصناعات الورقية ذ.م.م  
SEASON LEAD EDGE PAPER INDUSTRIES CO. W.L.L

## CORNERBOARD

Protection, stability and stacking strength

Small lengths of Corner Board which can be applied under steel or plastic strap so that the strap does not cut into the product or the carton when it is tensioned.



## PROTECTION OF EDGES

Cornerboard protect and support products during any handling operations.

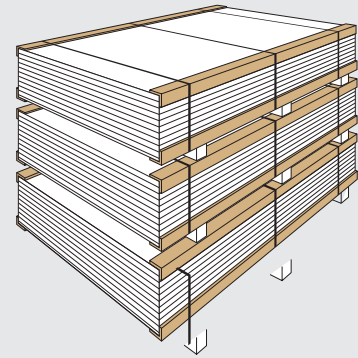

## INNER/OUTER DIAMETER PROTECTORS

Inner/outer diameter protectors protects the edges of circular reel from edge damages



## SELF-ADHESIVE

The use of self-adhesive Cornerboard improves handling by keeping Cornerboard in place before final strapping is applied.

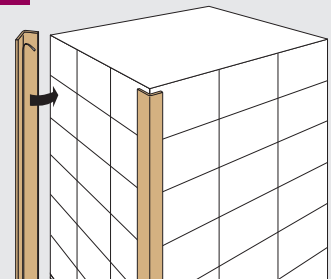

Sustainable packaging is your contribution to the environment



P.O. Box 886, Manama, Kingdom of Bahrain



+973-17 704647



+973-17 704648



info@season-leadedge.com



www.season-leadedge.com



FROMM develops and produces a wide variety of systems for unitizing and palletising goods for transport: strapping machines and systems, pallet stretch wrapping machines, the patented pillow system.

## FROMM STRAPPING TOOLS

### PNEUMATIC PLASTIC STRAPPING TOOLS

P355

**Strapping Qualities:**

- Polypropylene (PP) and Polyester (PET)

**Strapping Dimensions:**

Width= 10.0-16.0mm / 3/8- 5/8"

Thickness= 0.40 - 1.05mm / .016 - .041"

**Average Seal Strength:** approx. 75% of strap breaking strength

**Type of Seal:** Friction weld sealing

**Strap tension:** 400 - 2100N / 90 - 470lbs (adjustable)



P356

**Strapping Qualities:**

- Polyester (PET)

**Strapping Dimensions:**

Width= 16.0-19.0mm / 5/8- 3/4"

Thickness= 0.40 - 1.35mm / .016 - .053"

**Average Seal Strength:** approx. 75% of strap breaking strength (depending on strap quality)

**Type of Seal:** Friction weld sealing

**Tension:** 800 - 3700N / 180 - 830lbs (adjustable)



### BATTERY PLASTIC STRAPPING TOOLS

P328

**Strapping qualities:**

Polyester (PET) and Polypropylene (PP) plain and embossed

**Strapping dimensions:**

width 12.0 – 16.0 mm

Thickness 0.40 – 1.05 mm / .016 – .041"

**Type of seal:** Friction weld sealing

**Average seal strength:** approx. 75% (depending on strap quality)

**Tension force:** 250 – 2600 N / 56 – 585 lbs (adjustable)

**Tension speed:** 67 – 124 mm/s / 2.6 – 4.9 inch/s



P329

**Strapping Qualities:**

- Polypropylene (PP) and Polyester (PET) • Plain and Embossed

**Strapping Dimensions:**

Width= 16.0-19.0mm / 5/8- 3/4"

Thickness= 0.65 - 1.35mm / .026 - .053"

**Average Seal Strength:** Up to 75% (depending on strap quality)

**Type of Seal:** Friction weld sealing

**Strap tension:** 500 - 4000N / 112- 900lbs (adjustable)

**Power supply:** Battery 18 VDC / 4.0 Ah Li-Ion

P331

**Strapping Qualities:**

- Polyester (PET) • Plain and Embossed

**Strapping Dimensions:**

Width= 19.0-32.0mm / 3/4- 1 1/4"

Thickness= 0.60 - 1.53mm / .024 - .060"

**Average Seal Strength:** Up to 75% (depending on strap quality)

**Strap tension:** 1200 - 7000N / 270- 1575lbs (adjustable)

**Power supply:** Li-Ion 36 VDC / 2.5 or 4.0 Ah



## FROMM STRAPPING TOOLS

### PNEUMATIC SEAL LESS COMBINATION STEEL STRAPPING TOOL - A380

**Strapping qualities:** Uniflex and Ultraflex max. 1100 N/mm<sup>2</sup> / 160'000 psi  
**Strapping dimensions:**  
**Width :** 12.7 – 25.0 mm / 1/2 – 1”  
**Thickness :** 0.50 – 1.00 mm / .020 – .040”  
**Weight :** 17.4 and 18.4 kg / 38.4 and 40.6 lbs with suspension  
**Average seal strength :** Approx. 80 %  
**Strap tension :** The tool is available for different stages of strap tension  
**Suspensions (Optional) :** Suspension bracket for standard application is supplied with the tool. Four different suspension brackets are available



### MANUAL SEALLESS STEEL STRAPPING TOOL – A333

**Strapping qualities:** Uniflex regular duty max. 850 N/mm<sup>2</sup> / 123'000 psi  
**Strapping dimensions:**  
**Width :** 12.7 – 20.0 mm / 1/2 – 3/4”  
**Thickness :** 0.38 – 0.58 mm / .015 – .023”  
**Weight :** 3.9 kg / 8.6 lbs Normal version 4.3 kg / 9.5 lbs TW version  
**Average seal strength:** Approx. 80 %  
**TW-version available:** Torque wrench tensioning system  
**Suspension (Optional):** Bolt and grip ball for horizontal applications; have to be ordered separately  
**Suspension bracket for vertical applications;** has to be ordered separately



### MANUAL PUSHER TYPE STEEL STRAPPING TOOL

#### Characteristics A301 – Manual tensioner for flat objects

**Strapping qualities:** Uniflex and Ultraflex max. 1100 N/mm<sup>2</sup> / 160'000 psi  
**Strapping dimensions:**  
**Width :** 19.0 – 32.0 mm / 3/4 – 1 1/4”  
**Thickness :** 0.63 – 1.00 mm / .025 – .040”  
**Weight :** 3.5 kg / 7.7 lbs  
**Seals :** Semi open or overlap seals,  
**Sealing:** With separate manual sealer model A412



#### Characteristics A412 – Manual sealer

**Strapping qualities:** Uniflex and Ultraflex max. 1100 N/mm<sup>2</sup> / 160'000 psi  
**Strapping dimensions:**  
**Width :** 19.0 – 32.0 mm / 3/4 – 1 1/4”  
**Thickness :** 0.63 – 1.00 mm / .025 – .040”  
**Weight :** 3.4 kg / 7.4 lbs  
**Average seal strength:** approx. 75% Seals: Semi open or overlap seals, see chart  
**Type of joint:** Double notch up cut joint  
**Tensioning:** With separate tensioner model A301

### MANUAL PLASTIC PET STRAPPING TOOLS

#### P404

**Width :** 15-16 mm  
**Thickness :** 05-09 mm



#### P403

**Width :** 11-13 mm  
**Thickness :** 04-09 mm



## AUTOMATIC & SEMI-AUTOMATIC TABLE STRAPPING MACHINE AND AIR PAD MACHINE

### AUTOMATIC STRAPPING MACHINE

#### PM308

Strap Qualities:

- Polypropylene (PP)

**Strap Dimensions:** Width 8.0-15.5 x Thickness 0.55-0.70 mm

**Strap Tension:** 100-700 N (adjustable)

**Sealing Method:** Heat Welding

**Power Supply:** 230V / 50 Hz, 1 phase

**Power Consumption:** 1.2 kWh

**Strapping Seed:** 2.2 sec./cycle (27 cycles/min) approx.

**Dimensions:**

Length: 1430 mm

Width: 620 mm

Table Height: 810 mm

Weight: 220 kg Machine Weight

**Standard Arch Size:** 850 x 600 mm

**Temp. of working environment:** 5 ~ 40°C



### SEMI-AUTOMATIC STRAPPING MACHINE

#### PM206

Strap Qualities:

- Polypropylene (PP)

**Strap Dimensions:**

**Width:** 6.0-15.5 mm

**Thickness:** 0.50-0.75 mm

**Strap Tension adjustable:** 150-450 N

**Sealing method:** Heat Welding

**Power Supply:** 230V / 50 Hz

**Power Consumption:** 0.25 kWh

**Strapping speed:** 2.5sec./cycle (approx. 24 strapping cycles/min.)

**Dimensions:**

Length: 902 mm

Width: 586 mm

**Table Height:** 760-930 mm (adjustable)

**Weight:** 85Kg

**Strap core inned diameter:** 200/230/280 mm (interchangeable)

**Temp. of working environment:** 5 ~ 40°C



### AIR PAD MACHINES

#### AP100

- User friendly and easy to operate
- Easy roll change and short start up time
- Ergonomic, integration with mobile bin
- Stand alone hopper
- Highly reliable and low maintenance

Pad Sizes: 200 x 135 mm / 200 x 200 mm

Film Width: 200 mm, 400 mm

Film Thickness: from 20 to 35 my

Film Quality: PE

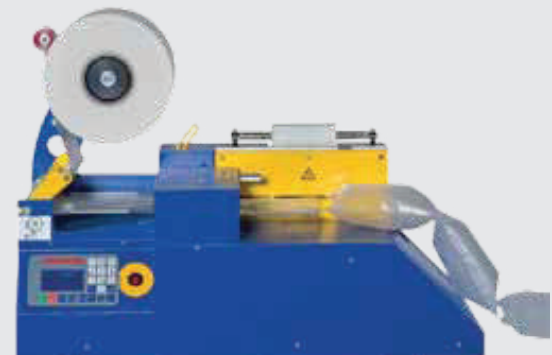

## FILM WRAPPING MACHINE & AIR PAD MACHINES

### AUTOMATIC ORBITAL FILM WRAPPING MACHINE

#### FV350-90 Automatic Inline Orbital Wrapping Machine

Code : FV350/90

The Fromm FV350-90 Automatic Inline Orbital Wrapping Machine is an automated system to stretch wrap long products such as pipes, tubes and rods. This fully automatic programmable machine with a 900mm diameter ring, when combined with conveyors, and safety systems is the ideal solution for small process lines.

Extremely low maintenance, the Fromm FV range is exceptionally easy to install & operate - Plug and play, no fuss. All equipment is supported by our on-site mobile service team and spare parts if needed are readily available. Optional extra's include - Top presser, side rollers, driven conveyors, automatic driven rollers, short product bridge.

#### FV350

- CE Certified
- Proven quality with competitive price
- Easy operation, simple maintenance
- Double film reel dispenser
- Ring protection
- Adjustable stretch film tension
- Automatic film cutter and clamp

#### Technical Data

Ring Diameters: 50/90/125/160/200/250 cm

Standard Film quality: 23 μm

Film Quality: 17,23 or 30

Film reel dimensions: 100,170, 250 mm

Ring Speed: 50 rpm to 350 rpm

Speed inverter/ PLC: Fuji / Omron

Power Supply: 230V / 50/60 Hz

Power Consumption: 0.40-1.66 kWh

Line Speed: up to 30m/min



### VERTICAL STRETCH WRAPPING SYSTEM

#### Simple solutions for wrapping pallets

FROMM stretch wrappers are extremely user-friendly and can be used in every situation. The programs are very easy to operate and extremely flexible.

All the Stretch Wrapping Machines are designed to cope with a high workload. The use of carefully selected components keeps maintenance to a minimum.

#### Strapping systems for all needs

The current range of products includes more than 40 basic models of strapping tools (pneumatic, electric and manual) and semi-automatic and fully automatic strapping systems.

#### Securing products around the world

FROMM manufactures a complete line of packaging products and equipment for unitizing and palletizing industrial loads. Customers throughout the world rely on the innovative products developed by FROMM to secure goods.

The current product range includes strapping tools and systems, stretch wrapping machines and the patented Airpad machine that produces protective packaging and void fill material.



**FS400**

## STRETCH WRAPPING MACHINES

### FS3XX Series Budget Stretch Wrapping Machines

#### Machine Features

- Adjustable Speed Turntable
- Adjustable bottom wraps
- Adjustable Speed carriage
- Adjustable top wraps

#### Machine Specifications

- Space saving machine with diagonal hinged mast (FROMM patent)
- Turntable Height: 75 mm
- Turntable Diameter: 01.500 mm
- Max. Loading Capacity: 01.500 mm Turntable: 1350 kg
- Turntable Diameter: 01.650 mm
- Turntable Diameter: 01.800 mm
- Loading Capacity: 0.1650 mm and 0.1800 mm turntable: 2.000 kg
- Horse shoe turntable: 0.1650 mm
- Max loading capacity: 01.650 mm
- Horse shoe turntable 0.1650 mm: 1250 kg
- Gearbox / Chian tension reducer (FROMM Patent)
- Column 2200 mm- Pallet height 2100 mm + 100 mm
- Column 2500 mm- Pallet height 2400 mm + 100 mm
- Column 2800 mm- Pallet height 2700 mm + 100 mm
- Max height of film core: 500 mm
- Max diameter of film core: 250 mm
- Power Supply: 1Ph / 230 v
- Weight: 500 kg

#### Available Options

FS330/FS331/FS332/FS333



## FS360 SEMI-AUTOMATIC STRECH WRAPPING MACHINE

#### Machine Features :

- Turntable speed from 6 to 12 rpm
- Carriage speed from 2 to 4 meters/minute
- Capacity of pallets per day depends on high/low rpm, pallet height and wrapping mode
- Hours of operation 8 h/day, 5 days/week
- FS360 Sealing height maximum of 2.100mm / 82.67"
- Wrapping machine max. weight Ø1.500mm 1.500kg
- Wrapping machine max. weight Ø1.650mm 2.000kg

#### Conditions :

- Environmental temperature + 5o to +30oC
- Environment clean, dry and not corrosive

#### Electrical System :

- Power supply 1 x 230 V 50/60Hz
- Control voltage 24 V/dc
- Turntable motor 0.55kW
- Mast motor 0.18kW
- Film carriage motor 0.37kW
- Installed power 1.1kW

#### Goods on pallet :

- Pallet dimensions (Length x width) Ø1500mm 800 x 1200 x 140 / 31.5" x 47.24" x 5.51"
- Pallet dimensions (Length x width) Ø1650mm 1100 x 1200 x 140mm / 43.30" x 47.24" x 5.51"



## SELF ROTATING ROBOT MACHINES

### FR33 Series

#### FR33x Series Robot stretch Wrapping machines with C2 carriage

Self- propelled machines for wrapping stacked loads with protective LLDPE film, with one or multiple wrapping programs and various pre-stretch systems

The FROMM robot is a mobile, semi- automatic stretch wrapping machine. It is particularly suitable for customers who need to wrap a wide range of large pallets or for situations where stretch wrapping takes place in various locations. With the battery fully charged, it can wrap up to 180 Euro pallets.

#### FR330 with C2

Mechanical brake system (20 - 70% tension), Equipped with simple OP1 or sophisticated OP2 control panel.

#### Available Options

FR330/FR350/FR390/FR400



## STRETCH WRAPPING MACHINES

### FROMM Turntable

Strong rigid structure, maintenance-free chain drive and short basic length to save space,  
Start – stop soft start and return to ZERO position,  
Start wrap height bottom wraps adjustable on turntable level (bottom pallet),  
Sound level ← 80dB with cast film, anti slippery treatment ,  
Transport by means of 2 holes for forklift truck at the front side.

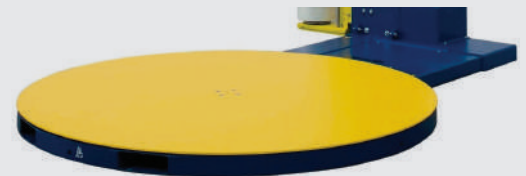

### FV205

Reliable and multifunctional semi- automatic, vertical stretch wrapping systems with mechanical film brake adjustable by means of a hand wheel. The film is applied vertically. Suitable for wrapping long products, like profiles, wood, aluminium, steel, stainless steel etc. With a wide range of Semi automatic machines starting with diameter 400 followed by 600- 1.000 and 1.400 mm.

#### Benefits:

- Attractive and competitive price level
- Minimum maintenance required
- Inside Ring Diagonal 390 mm
- Easy to operate control panel
- Automatic cutting divide for the film
- Automatic stop in zero position
- Adjustable vertical guide unit
- Acceleration & deceleration speeds controlled by inverter
- Working height 870-960 mm
- Supply complete with CE\_declaration of conformity
- Conveyors in various lengths

Standard technical specifications

Maximum diameter goods: 390 mm

Min dimensions: 30 x 30 mm (W x H)

Max Dimensions: 250 x 200 mm (W x H)

Max Weight: 25 kg per meter



**GARBAGE BAGS**

Garbage Bags are available in HDPE and LDPE in various sizes under **Lotus brand**.

Standard Sizes	
5 gallon	( HDPE )
10 gallon	( HDPE )
30 gallon	( HDPE & LDPE )
50 gallon	( HDPE & LDPE )
70 gallon	( HDPE )



Customized sizes and colours are also available.

**LDPE GARBAGE BAGS**



**FLAT GARBAGE BAG**



**BIN BAG**



**LDPE BAGS**

Available in Bottom Sealing & Side Sealing



**PP BAG**

Available in Bottom Sealing & Side Sealing



**HDPE SHOPPING BAGS**



## Balers & Waste Compactors

### World leader in compaction

Orwak is a world leader in compaction and baling solutions for solid waste material at source. Orwak has developed comprehensive range of waste compactors, baling systems and the "Brickman" briquette presses for recyclable materials that make waste management more profitable. Orwak solutions achieve ten times less to give you ten times more in order to help you realize your waste management goals in the most profitable way.

- Less transport means more money
- Less disposal means more income
- Less handling means more efficiency
- Less clutter means more space
- Less risk is more security
- Less time means more productivity
- Less mess means more hygiene
- Less trouble means more satisfaction
- Less energy means more savings
- Less pollutions more cleanliness

### Application Area

- Food Retailers
- Non-Food Retailers
- Hotels & Restaurants
- Industry
- Warehouses
- Logistic Centers

### ORWAK MULTI 5070-COMBI

#### Benefits :

- More Productive use of time.
- More Space & Order
- Less Costs, More Value
- Dual Function Unit
- User-Friendly
- Versatile
- Extendable System
- Designed for Standard Bins
- Bale Trolley

**Loading Aperture :** Width 700mm, Height 500mm

**Cycle Time :** 36 secs

**Press force :** 3 ton. 30KN

**Bale Size :** Width 700mm, Depth 500mm, Height 700mm

**Bale Weight :** Cardboard up to 50 kg.

**Plastic :** up to 80 kg

**Noise Level :** < 70 db (A)

**Protection Class :** IP55

**Operating Power :** Single Phase 230V, 50 Hz, 10 A



### ORWAK POWER 3420

#### Benefits :

- More Productive use of time.
- More Space & Order
- Less Costs, More Value
- Low-built design for easy transportation and successful installation where space is limited
- Silent operation
- User-friendly panel
- Material selector HP (cardboard) & LP (plastic)
- Bale indicator
- Bales can be secured by polyester straps or wire

**Loading Aperture :** Width: 1200 mm; Height: 520 mm

**Cycle Time :** 24 secs

**Press force :** 26 ton 260kN

**Bale Size :** Width 1200mm, Depth 800mm, Height 1150mm

**Bale Weight :** Cardboard up to 400 kg.

**Plastic :** up to 450 kg

**Noise Level :** < 65 db (A)

**Machine Weight :** 1080 KGs

**Operating Power :** 3 Phase 3 X 400 V, 50Hz





## ORWAK MULTI 9020S

**Benefits :**

- More Productive use of time. • More Space & Order
- Less Costs, More Value • High-capacity system
- Safety brake as standard • Extendable system
- Bale indicator • Efficiency

**Loading Aperture :** Width: 1100 mm; Height: 700 mm

**Cycle Time :** 35 secs

**Press force :** 20 ton 200kN

**Bale Size :** Width 1100mm, Depth 700mm, Height 800mm

**Bale Weight :** Cardboard up to 200 kg.

**Plastic :** up to 300 kg

**Noise Level :** ← 72 db (A)

**Protection Class :** IP55

**Operating Power :** 3 Phase 3 X 400 V, 50Hz



## ORWAK FLEX 5030

**Benefits :**

- More Productive use of time. • More Space & Order
- Less Costs, More Value • versatile
- High compaction ratio on the spot • User friendly
- Hygienic waste handling • Optional accessories for flexibility

**Loading Aperture :** 500mm

**Cycle Time :** 36 secs

**Press force :** 3 ton. 30kN

**Chamber Dimensions :** (Internal) width : 500mm, Height 800mm

**Noise Level :** 62 db (A)

**Protection Class :** IP55

**Operating Power :** Single phase 230V. 50Hz. 10 A



## ORWAK TOM 1040

### Waste Compaction System For Public Spaces

**TOM** saves, space and energy, and all of that saves you money. Holding up to seven times more waste than a conventional waste bin and featuring hands-free operation, **TOM** also keeps your environment tidy and hygienic.

#### Dimensions and Specifications and Specifications

Dimensions					Utilities	Capacity
Width	Depth	Height	Transport Height	Machine Weight	Power	Compaction Ratio
24"	29"	4'9" - 4'11"	5'4" inc.pallet	246lb	100-240v 50/60Hz	Up to 7:1



## AIR BUBBLE

Our product AIR BUBBLE, a laminate of two layers of embossed and flat polyethylene film, one layer is embossed into a sheet with bubbles. Another is laminated against the open side of the bubbles.

### Advantages/Characteristics:

- Use for wrapping and cushioning.
- Ideal for shipping fragile items.
- Provide maximum protection.
- Lightweight saves postage.
- Chemical and shock resistance (Antistatic).
- High degree of flexibility.
- No absorbance of humidity and moisture.
- Waterproofing.
- Easily to apply and made in pieces.
- Competitive prices compared to other packing products.



### Available Sizes

- Rolls 1.5 Mtr with different grade
- Rolls 0.75 Mtr with different grade

## EPS FOAMS

PE-Foam is very resilient and used extensively in packaging, it is directly in sheet form in varying densities, widths, thickness and colors.

### Characteristics:

- Closed cell
- Very light weight
- Non abrasive
- Easy to fabricate
- Non dusting
- Superb strength and tear resistance
- Excellent shock absorption and vibration dampening properties
- Flexibility
- Resistance to water, chemicals, solvents and grease
- CFC Free
- Very cost effective

Various packing method for electrical and electronic systems and appliances. Computers, picture frames, glass, furniture, sheet metal protection etc.

**Thickness** : 0.5mm to 20mm (Roll Form)

**Length** : As per requirement

**Density** : 25 - 50 Kg./M3



## PARQUET UNDELAY

- It extends life of wooden & laminate floorings
- It stops heat-cold transfer from and to the wooden floor
- It reduce noise transfer in multi layered buildings
- It doesn't absorb water
- It is non-poisonous and chemical resistant

Properties	Unit	Value	
Thickness	mm	2.0	3.0
Density	g/cm3	0.04	0.04
Moisture Permeability	g/cm2.24hr	0.24	0.39
Heat Dimensional Stability	%	4+	3+
		4+	3+
Water Absorption	mg/cm2	0.017	0.267



# GENERAL PACKAGING ITEMS

## BEEDS BAG

WEIGHT PER BAG 14 KGS



## THERMOCOL SHEETS

### Available Sizes

- 4" x 8" x 12mm
- 4" x 8" x 15mm
- 4" x 8" x 20mm
- 4" x 8" x 22mm
- 4" x 8" x 25mm
- 4" x 8" x 50mm
- 4" x 8" x 200mm

with the density of 14, 24, 30 and 40

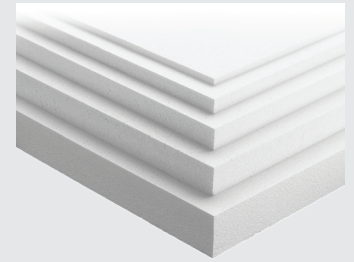

## CORRUGATED ROLLS

2 Ply Corrugated Rolls

### Available Sizes

130cm Height, 140cm Height  
155 Cm Height Etc..



## PLAIN CARTONS

Available 3 Ply & 5 Ply.

### Standard Sizes

Plain Brown Carton

18"x18"x18" (45.72 x 45.72 x 45.72 cm)

18"x18"x28" (45.72 x 45.72 x 71.2 cm)

24"x24"x24" (60.96 x 60.96 x 60.96 cm)



## PP CORRUGATED SHEETS

PP Corrugated Sheets are made from Impact Co-polymer of Polypropylene. It is an extruded hollow profile consisting of two flat walls connected by vertical ribs.

### Salient Features:

- Light Weight
- Strong
- Waterproof
- Chemical proof
- Vermin proof
- Recyclable
- Reusable
- Printable
- High Insulation
- Easy Fabrication
- Impact Resistant
- Puncture Resistant
- Tearing Resistant
- Custom Made
- Live Hinge

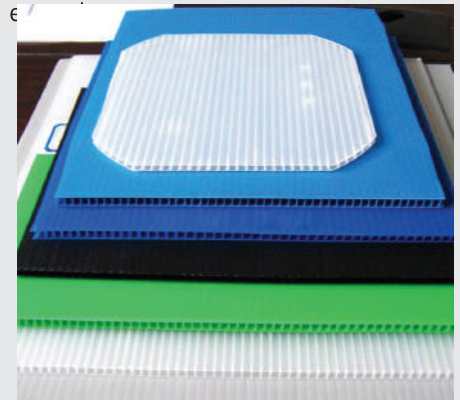

**Thickness (mm)** : 1.7mm to 10.0mm

**Standard Sizes** : 1830 X 1220mm, 2000 X 1300mm, 2440 X 1220mm, 2000 X 1000mm, 3000 X 2000mm, 1220 X 2440mm

**Standard colors** : White, Yellow, Red, Black, Green, Blue, Grey, Natural

## PAPER CORES



## IRON OXIDE



# GENERAL PACKAGING ITEMS

## TAPE DISPENSER

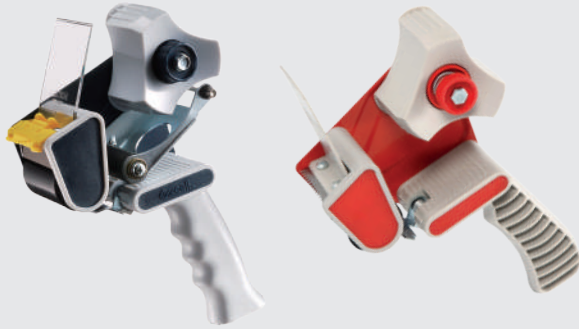

## STRETCH FILM DISPENSER



## BAG SEALERS



## HAND PALLET TROLLEY & FLAT BED TROLLEY



## THERMAL LABEL WITH RIBBON



## COTTON WASTE



## POLYTHENE SHEETS

### Commercial Grade :

- 3mtr X 12 Mtr X 80 Mic
- 3mtr X 12 Mtr X 100 Mic
- 3mtr X 12 Mtr X 125 Mic
- 3mtr X 12 Mtr X 200 Mic
- 3mtr X 12 Mtr X 250 Mic

Available with different grade and sizes



## DESSICANT BAG(DRY BAG)

- Silica Gel 20 g
- Silica Gel 50 g
- Silica Gel 100g/pack
- Silica Gel 500 g with hook
- 1kg Bag with Hook



# GENERAL PACKAGING ITEMS

## FLEXIBLE CLEAR STRIPS



Available with different grade and sizes

## PLASTIC PALLETS & CRATES



Available with different grade and sizes

## WOODEN PALLETS



Available with different grade and sizes

## UNBLEACHED INTERLEAVING KRAFT PAPER



## PVC TARPALINE



Available with different grade and sizes

## IMPLUSE SEALER



Available with different grade and sizes

## VCI PAPER

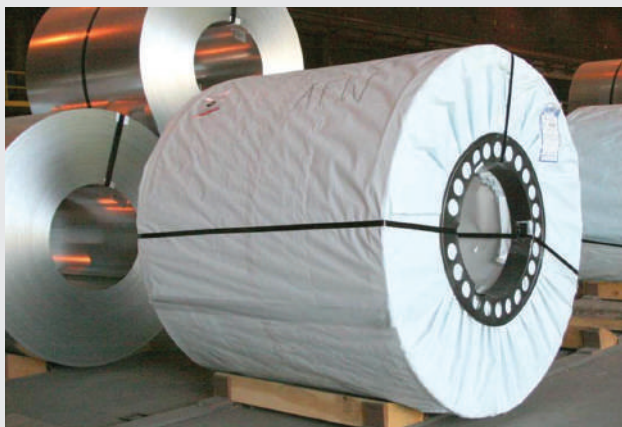

## PANREX PNEUMATIC FASTENING TOOLS

Panrex is dedicated to advanced technology through extensive research development.

Establishing a complete fastening system to mark our tools safe, convenient and easy-to-operate is our target. Through international certificate, Panrex also developed a special technique such as:

- Nail driving with safety device
- Adjustable work contacting element
- Anti-double fire mechanism, single or contact firing
- Patented driver design for durable use
- Fast-cycle rate to nail 15 nail/ second
- Powerful and easy cap release
- One-step jam clearance
- Dry-fire lock
- Unique nail guide lock and easy nail length adjustment

### PR0034P

- Type of Nail: Clipped head paper collated
- Weight: 7.74 lbs (3.52 Kg)
- Operating Pressure: 80-120 Psi (5.5-8.3 Kg / cm<sup>2</sup>)
- Fasteners Length: 50-100 mm (2" - 4")
- Magazine Angle: 31
- Tool Height: 14" (356 mm)
- Shank Dia.- .113" - .148" (2.87-3.8 mm)
- Capacity: 90 Nails



### PCN 670s

- Shank: .099"-.131" (2.5-3.3 mm)
- Collation Angle: 15" Wired Welded and sheet collated
- Operating Pressure: 70- 120 Psi (4.9-8.3 kg/ cm<sup>2</sup>)
- Head Dia: .224"-.275" (5.6-7.0 mm)
- Weight: 6.5 lbs (2.97 kg)
- Load Capacity: 150 - 300 Nails



### PR 16851S

- Gauge Size: 16GA
- Width x Thickness
- Weight: 4.8 lbs (2.18 kg)
- Operating Pressure: 80- 120 psi (5.5-8.3 kg / cm<sup>2</sup>)
- Crown Size: 7/16" (10.6-11.2 mm)
- .063" x .055" (1.6 x 1.4 mm)
- Load capacity: 147 Staples



### PCN 557S

- Shank: .083"-.092" (2.1-2.3 mm)
- Collation Angle: 15 Wire Welded and sheet collated
- Operating Pressure: 70-120 psi (4.9-8.3 kg / cm<sup>2</sup>)
- Head Dia: .189"- .224" (4.8-5.6 mm)
- Weight: 5.3 lbs (2.4 kg)
- Load Capacity: 250 - 400 Nails



### PR1850F

- Gauge Size: 18 GA
- Width x Thickness: .050" x .039" (1.25 x 1.0 mm)
- Operating Pressure: 70- 120 psi (4.9-8.3 kg/ cm<sup>2</sup>)
- Length: 5/8" - 2" (15-50 mm)
- Weight: 3.08 lbs (1.4 kg)
- Load Capacity: 100 Nails



## GENERAL ITEMS

### STAPLES

16 Gauge Galvanized Staples  
Staples- DF76136 (10,000 pcs)  
32 mm 16G, 7/16" CROWN  
1-3/16" LEG

### STAPLES F76200 (10,000 PCS)

16GA, 7/16" CROWN  
2" LEG  
Staples W1. 26m x L22mm x T1, 00mm x 5mm (K-422)



### BRADS

Available Size  
F-15, F-40 & F-50

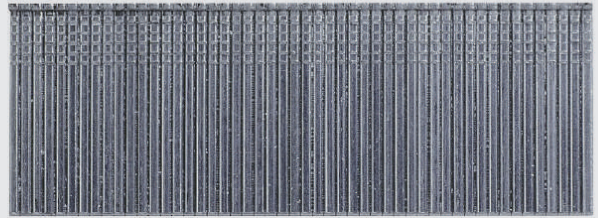

### STRIP NAIL

34 degree, Paper Collated Strip Nails with clipped head  
Available Sizes  
3.1 x 90 mm Ring Bright  
3.4 x 90 mm Smooth Bright

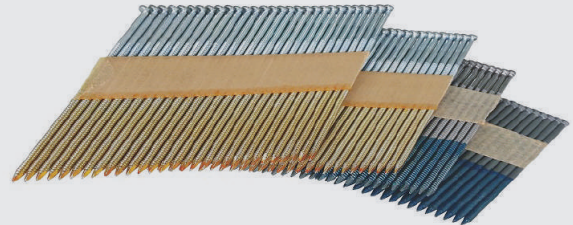

### 15 DEGREE WIRE WELDED COIL NAILS

Available Sizes  
2.5 X 57 mm (9000 pcs)  
2.5 x 45 mm (275 pcs x 30 coils)  
2.8 x 57 mm Screw Bright (250 pcs x 30 coils)

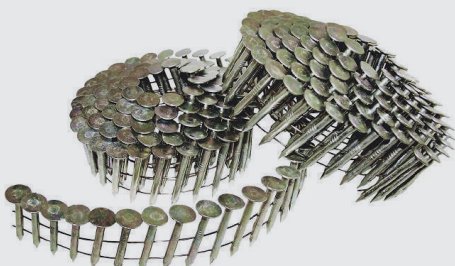

### BLACK ANNEALED WIRE

Material: Low Carbon Steel Wire



## STARSTRAP™ SUBSTITUTES STEEL STRAPPING

As a leading manufacturer of quality tools and equipment for various types of strapping products, FROMM owns three production operations for STAR Strap Polyester strapping worldwide. The facilities are in Kolleda, Germany, in Santiago, Chile and in Bangkok, Thailand

### STARstrap™

The New High Performance Polyester Strapping

Polyester strapping are characterized by a very consistent tensile strength and a very high elongation. Characteristics that are most decisive for a safe strapping method. Unlike strapping made from steel, Polyester strapping have a high elongation and absorb shocks and impacts during transportation and handling far better than steel strapping. The excellent elongation features allow the substitution of steel strapping for the same application with a Polyester strap having a lower breaking strength.



### The Modern Polyester Strapping System Offers Many Advantages

STAR Strap Polyester strapping offers excellent mechanical features such as high breaking strength, outstanding elongation and perfect tension retaining capabilities

#### These characteristics result in:

- No damage or contamination of packaged goods (corrosion-resistant).
- High shock absorption in case of impacts during transportation.
- Less pressure on edged of the package.
- Perfect and individual secured packages.
- Strap tension remains tight in cases where package may shrink during storage or transportation
- Substitution of steel strapping by STAR Strap Polyester strapping allows the use of a strap with less breaking strength.
- Reduction of material costs (up to 50 %).
- Less injury risks in case of strapping breakages.
- Easy and clean handling compared to steel strapping.

## PP STRAP

### Features :

- PP Straps are available in 5, 6, 8, 9, 10, 11, 12, 15, 16 & 18mm width and in white, various colors & Natural too with online Rotogravure printing facilities, giving excellent printing result on the strap.
- They are manufactured through the most sophisticated, hi-tech fully automatic plant giving us an edge over other manufactures.
- They perform smooth and trouble free running on fully automatic machines even at very high speed packing operations.
- Customization of the product with precise & specific requirement is also entertained.

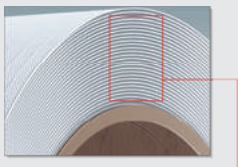

Most Precise winding for hassle-free operation



Gap free flat winding for smooth flow

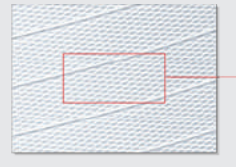

Embossed design for better aesthetics and slip-free operation

## PP BUCKLE/CLIP FOR STRAPPING BAND, SUITABLE FOR LIGHT TO HEAVY PACKING WITHOUT BANDING TOOLS

### Key Specifications/Special Features:

- Sizes: 13, 16 and 19mm
- Maximizing cost-effective production by replacing film wrapping
- Neat and clean results Material that is flame-resistant can be offered





## STEEL STRAPPING

- Steel Coil Packing
- Steel Sheet Packing
- Rectangular Bulk Packing
- Rectagonal Packing for Steel Tube
- Hexagonal for Steel Tube
- Timber Packing
- Brick Packing
- Other Heavy Weight Products Packing

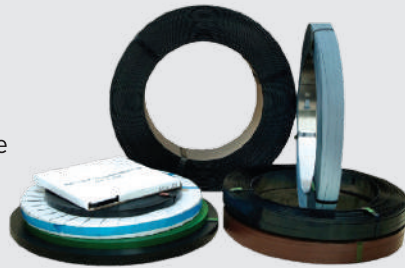

### Inner Diameter for strapping

Oscilated (Mill, Rope wound): I.D 406mm

Ribbon: I.D 300mm and 406mm

Mini Ribbon: I.D 200 mm

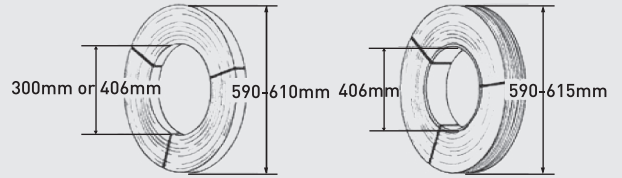

## WOUND TYPE

### • Oscilated Wound or Mill Wound

The Steel Strapping is wound in a tight uniform pattern to a coil width between 12.7mm - 19.0mm

### • Ribbon Wound (RW)

The steel Strapping is wound onto itself so that the width of the coil is the same as that of the strap.

### • Jumbo Coil

Jumbo Coil can be wound into coils that weight greater than 150kg (330lbs), Jumbo coils are available for all steel strapping types in size from 19mm to 32mm, and coil weight from 150kg (330lbs) to 450kg (1.000lbs).Jumbo coil have a standard.



Oscillated Wound (OW)



Ribbon Wound (RW)

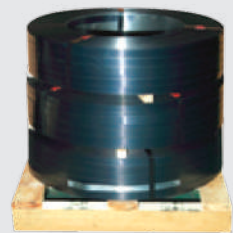

Jumbo Coil

## SNAP ON OPEN SEALS

Fast and easy to use, open seals can be placed over the strap before or after tensioning.

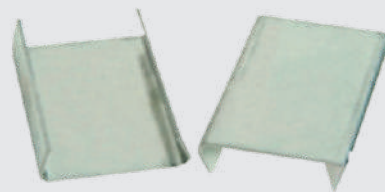
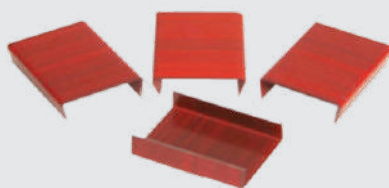

## THREAD-ON (CLOSED ) SEALS

Must be threaded over the overlapping straps ends before the tensioning tool is applied.

Generally used on bales, bundles and larger sizes of strap.

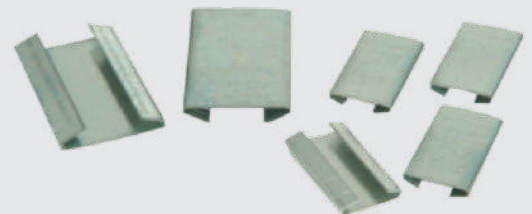

## PUSH TYPE SEALS

Used Where strap is tensioned by butting the nose of the tensioner against the seal, overlapping ends withstand the higher stress.

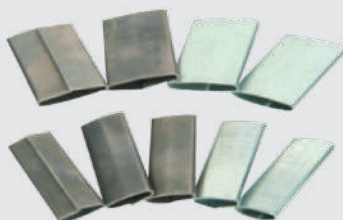

## STEEL STRAP DISPENSER



## COVERALL

**Features:**

**100 % Cotton Coverall**

- 240 GSM, Full Sleeves, WORKSTAR Brand
- Heavy Duty 2 Way Visilon Zipper

**65% + 35 % TC Coverall**

- 150 GSM, Full Sleeve

Available Colors : Light Blue, Navy Blue, Khaki, Green & Grey

- 65%+35% High Quality Long Sleeves Coveralls
- 100 % Cotton Heavy Duty Coveralls
- 100 % Cotton Coveralls with Reflectives Tapes
- 100 % Cotton Pant & Shirts with different brands.



## SURGICAL MASK / FACE MASK

**Features:**

- 3Ply, Round Ear-Loop.
- Material : SPP/MB/SPP = 18/20/25 g/m<sup>2</sup>
- Color - Blue
- Size : 9.5cm X 17.5cm
- Packing : 50 Pieces/Box  
2000 Pcs/Carton
- Carton dimension: 52 x 38 x 35cm



## DUST MASK

50 Pcs Per Box &  
20 Box Per Ctn.



## FILTER MASK

Available in

- V-230 SLV FFP3
- V-420-FFP2
- V-425-FFP2
- V-430 FFP3



## EAR MUFF



## EAR PLUG

With Cord & Without Cord



## FACE SHIELD WITH BRACKET



## MASK WITH CHEMICAL CARTRIDGE

Brief Specification: Half mask Face-piece in soft TPE material (Thermoplastic Electrometric) in grey colour. It is equipped with dual filter which ensures better breathing comfort.



## TRAFFIC CONE

Available Size :

50 cm, 75cm & 1mtr

- Rubber Base & Plastic Base



## SAFETY FENCE



# SAFETY

## SAFETY GLASS ECONOMY & EXECUTIVE

Available In Clear & Dark



## SAFETY VEST JACKET GREEN & ORANGE

Available in 2 strip & 4 strips  
Sizes : L, XL & 2XL  
Also, available in fabric & net cloth



## CARGO LASHING BELT

Size : 2" X 10 Mtrs



## COTTON GLOVES

Cotton Glove and Palm  
Dyed Knitting Cuff



Available in Bleached & Unbleached

## DOTTED GLOVES

Cotton Glove and Palm  
Dyed Knitting Cuff



## LEATHER WORK GLOVES

Cow Split Leather work Gloves  
Rubberized Cuff  
Reinforced Palm Lines  
Size : 10.5 inch



Available in :  
Light duty, Medium duty & Heavy duty

## LEATHER WELDING GLOVES

Red Cow Split Welding Gloves  
Size 16 inch available



## ALL FLEX GLOVES



## BLACK FOAM NITRILE GLOVES

### PROTECTOR



## NATURAL LATEX CHLORINATED, FLOCKED LINED



## LATEX COATED POLYAMIDE & COTTON GLOVES



## CUT RESISTANT GLOVES LEVEL 5



## SAFETY HELMET

Safety Helmet MSA Half Brim  
Avalable Colors : Blue, Green, White & Yellow



## SAFETY HELEMT STURDY WITH CHIN STRAP

Available Colors :  
Yellow, White, Blue & Green



## 3M ITEMS

### 3M™ Particulate Respirator 8511

- NIOSH approved for at least 95 percent filtration efficiency against certain non-oil based particles
- 3M™ Cool Flow™ Exhalation Valve helps reduce heat build-up inside the respirator



### 3M™ Particulate Respirator 8210

- NIOSH approved for at least 95 percent filtration efficiency against certain non-oil based particles
- Two-strap design with welded dual point attachment helps provide a secure seal



### 3M™ Particulate Respirator 8514

- Used in certain applications involving metal fumes
- Flame resistant per modified ASTM D2859 (not a substitute for a faceshield)
- Carbon filter layer reduces exposure to nuisance level odors



### 3M™ Foam Earplugs 1100 / 1110

- Smooth, dirt resistant surface provides better hygiene
- Earplugs are easy to roll down for quick and easy fitting
- Tapered design fits comfortably in earcanals
- Soft polyurethane foam is hypoallergenic



## SAFETY SHOES

### Safety Jogger X 1110

#### Features:

- Metal Free & Anti-static
- Slip resistant sole
- Heel energy absorption
- Anti-perforation steel-SJ Flex insole
- Oil & Fuel resistant sole
- Steel toe Cap/Composite toe cap
- Breathable Leather upper
- Water resistant upper



### Safety Jogger X0600

#### Features:

- Oil & Fuel resistant sole
- Steel toe Cap/Composite toe cap
- Breathable Leather upper
- Water resistant upper
- Slip resistant sole & Anti-static
- Heel energy absorption
- Anti-perforation steel-SJ Flex insole



### Safety Shoe Steps ACTIVA

#### Features:

- Shock Absorption
- Reinforced Leather
- Comfort Padding & Comfort Lining
- PU Ankle Protection & Heat Resistant Sole
- Composite Toe Cap & Anti-Slip Stability



### Safety Back Open Shoes Steps

#### Features:

- Genuine Leather
- Shock Absorption
- Foot Bed & Steel Mid Sole
- Steel Toe & Anti Slip Stability
- Rubber Padding

Available on request



### Safety Shoes Feet Guard

Low Cut & High Cut

#### Features:

- Reinforced Leather
- Comfort Padding & Comfort Lining
- PU Ankle Protection & Heat Resistant Sole
- Steel Mid Sole & Steel Toe Cap- 200J



### Safety Shoes Eurotech

Low Cut & High Cut

#### Features:

- Reinforced Leather
- Comfort Padding & Comfort Lining
- PU Ankle Protection & Heat Resistant Sole
- Steel Mid Sole & Steel Toe Cap- 200J



## SAFETY SHOES

### Safety Lace up Boot Slic 59102

**Features:**

- Six (6) inch Black lace-up safety boot with four speed lace ("D" rings).
- Barton Print buffalo leather Vamp lining non woven synthetic fabric.
- Sole of directly injected dual density Polyurethane with heel.



### Slic Safety Tie Shoe Sporty 59308

**Features:**

- Beige & grey sued leather + fabric sporty tie shoe with four rust resistance speed laces.
- Upper of suede leather and nylon fabric in quarter and collar.
- Collar/Tongue are padded with foam for extra comfort.



### Safety Shoe Slic 59351

**Features:**

- Black tie/lace with (4) eyelets safety shoe.
- Upper Barton print buffalo leather.
- Quarter & Tongue lined with cambrelle fabric with foam backed.
- Sole of direct injected dual density Polyurethane with heel.



### Safety Shoes Slic 4568

**Features:**

- Safety Shoe Slic WOL 4568
- Slip-on Black shoe.
- Upper full grain buffalo printed leather.
- Fully lined with Cambrelle to foam backed.
- Sole unit Single density PU with heel.
- Metallic Toe Caps meet ASTM & EN-12568 Standards.



### Safety Shoes Geibi

**UPPER**

- Breathable water repellent leather (S2-S3)
- Breathable leather (S1-S1P)

**LINING**

- Highly abrasion resistant, egective absorption
- odorless and relase of moisture



### Safety Boot Slic Brown 59526

**Features:**

- Six (6) inch brown lace up safety boot with six (6) rust proof eyelets.
- Upper of full grain buffalo leather.
- Quarter & Tongue lined with cambrelle fabric with foam backed.
- Vamp lining is lined with non woven fabric.



### Electrical Hazard Shoes Slic 89667

- Black tie safety shoe with four (4) rust proof coated eyelets and eye facing extended up to toe and foxing.
- Upper of black cow full grain soft printed leather.
- Fully lined with Dri-lex to foam backed.
- PU to Rubber outsole with EH Protection as per ASTM F2413-11 Standards.



Available on request

### Safety Lace Up Boot Slic 89679

- Brown lace-up boot with seven (7) round iodized eyelets and wide padded collar.
- Upper of brown cow full grain oil pull-up leather.
- Vamp lining Cambrelle to foam backed.
- PU to Rubber outsole with EH Protection as per ASTM F2413-11 Standards.



Available on request

### Gum Boots

Available in with Safety & Normal Gum Boots



### Safety Slic Welder Boot 5994

**Features:**

- Dark brown ten (10) inch pull-on Safety Boot.
- Upper made of buffalo printed leather.
- Sole of direct injected dual density polyurethane with heel.



## SHRINK FILM PVC CLING FILM & ALUMINIUM FOIL



Our line of quality PVC Shrink films offers endless possibilities for the packaging of retail and wholesale products. From general purpose to speciality, Shrink Films are engineered to perform under the most demanding circumstances.

- Applications for toys, boxes, frames, magazines, chocolates and candy boxes, cosmetics etc.
- Excellent clarity and gloss with tear resistance.
- Suitable for all kind of packaging used for manual, automatic and semi-automatic machines.
- Exceptional sealing characteristics or unbeatable product presentation.
- Films are available in single wound and center-folded.
- Well-balanced shrink performance in low tunnel temperatures and adaptability to the multiple forms of goods.

### Shrink Films:

Thickness: 12 to 30 Micron  
Width: 200 mm to 1,000 mm

### Fast Facts About POF Shrink Film

- Made of 100% recyclable materials
- Excellent clarity and glossy shelf appearance; great for consumer products where appearance is critical (toys, games, candies, books, foods, most retail items)
- Ability to shrink quickly and completely (shrinks when heated resulting in a finished good as soon as it comes out of the shrink tunnel)
- Durable, versatile, low cost
- Excellent for bundling multiple items together, like tissue boxes for example.
- Cross-linked POF is great for high-speed applications, providing added strength without compromising clarity and prevents build-up on sealing components
  
- Polyolefin is more expensive, but more durable- not as effected by temperature changes
- FDA approved for food contact
- Excellent tensile-strength and propagation-to-tear
- Pre-perforated POF is available and allows for even shrink surface, no air pockets

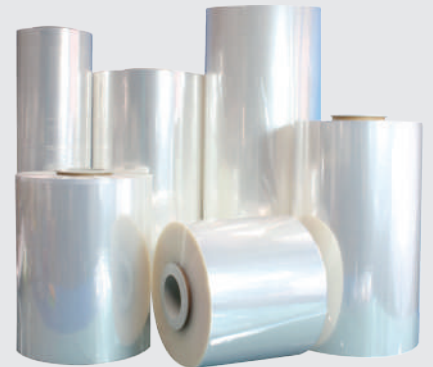

## PVC CLING FILM

PVC packaging plays a valid and valuable role in modern society. It is a versatile material, with excellent technical and commercial performance,

- Reducing food waste through protection of foodstuffs across the world providing great benefit to society.
- Wrap All keeps food, fruits and vegetables fresh & clean
- Wrap All had Excellent transparency which improves aesthetics of the product.
- Wrap All is flexible and just right to wrap around any shape and size of plates.
- Food grade material
- Excellent Stretch ratio.
- No Migration and hence does not attract dust nor deposition of the same
- Excellent weatherability



### Cling Films:

Thickness: 9 to 15 Micron  
Width: 300 mm to 450 mm

## ALUMINIUM FOIL

An early commercial use of aluminum foil

- One of the first commercial uses of aluminum foil came in 1913. Foil leg bands were used to identify racing pigeons.
- Innovative consumer product delivery
- Jiffy Pop Popcorn, released in 1959, combined a heavy-gauge foil pan and an expandable, light-gauge foil cover to deliver their "magic treat."
- Effective for energy conservation
- The "shiny" side of aluminum foil is 88 percent reflective, making it one of the best and most efficient insulators to solar heat.



## STRETCH FILMS

Stretch wrapping is a leading method for utilizing, bundling and pallet wrapping of goods. SITCO provides its customers with different stretch Wrap Packing Solutions.

- Excellent holding forces and puncture resistances for safe transportation.
- Easy handling to ensure reliable and safe packaging.
- Excellent barrier properties and moisture protection of the goods.
- High clarity for product and barcode identification.
- Several qualities available for manual and fully-automatic machine applications.

### Stretch Films:

Thickness: 20 to 50 Microns  
Width: 450 mm, 500 mm,  
750 mm & 1500 mm



## FIVE-LAYER POLYETHYLENE CAST STRETCH FILM

It is best suited for use in semi-automatic pallet wrapping machines.

### Features:

- Very good stretch capability
- High transparency and clarity
- Strong tear and puncture resistance
- Excellent barrier properties
- Robust five-layer structure

### Benefits:

- High value-in-use, most economical cost wrapping
- Easy barcode reading and visual product identification
- Protects goods from mechanical damage during shipping
- Protects goods from moisture, dirt, sand and dust
- Easy application, will not tear in the machine



## HR HAND-ROLL CAST STRETCH FILM

### Features:

- Good stretch capability
- High transparency and clarity
- Strong tear and puncture resistance
- Excellent barrier properties
- Robust five-layer structure

### Benefits:

- High value-in-use, most economical cost wrapping
- Easy barcode reading and visual product identification
- Protects goods from mechanical damage during shipping
- Protects goods from moisture, dirt, sand and dust
- Easy manual application



## MINI STRETCH FILM

### Benefits:

- Mini stretch film rolls measuring 100mm (width) x 150 metres (length)
- Made from high quality film
- Clings to itself without adhesives for a professional looking wrap
- Residue free, great for bundling small loads or as an alternative to strapping/tape



## EKH-455



**Power Supply:** 110 / 220 / 230 / 240 v., 50 / 60 hz., 1-phase  
**Max. Consumption Power:** 3.77 kw  
**Effective Power Consume:** 1.6-2.3 kw  
**Sealing Dimension:** 420 mm (d) x 550 mm (l)  
**Max. Height of Package:** 250 mm  
**Machine Dimension:** 1320 mm (l) x 820 mm (w) x 645 mm (h)  
**Max. Dimension of Film:** 600 mm x ø250 mm

## EKL-455MT



### EKL-455MT

**Power Supply:** 220 v., 60 hz., 3-phase ; 400 v., 50 hz., 3-phase  
**Max. Consumption Power:** 9 kw  
**Sealing Dimension:** 400 mm (w) x 550 mm (d)  
**Tunnel Inlet Dimension:** 400 mm (w) x 200 mm (h)  
**Max. Film Roll Dimension:** 600 mm x ø300 mm  
**Working Plate Height:** 900 mm  
**Machine Dimension:** 2570 mm (l) x 870 mm (w) 1600 mm (h)  
**Max. Packing Height:** 150 mm  
**Machine Weight:** 400 kg



## Carton Sealing Machine

### EXC-103SD

**Tape Width:** 1 1/2", 2"  
**Belt Speed:** 23 meters/minute  
**Capacity:** (L) 120 mm - (w) 110 mm  
- 500 mm (H) 120 mm - 500 mm  
**Power Supply:** 100 / 110 / 220 / 230 / 240 v,  
50 hz / 60 hz., 1-Phase  
**Power Consumption:** 450 w



### EXC-103TB



**Tape Width:** 1 1/2", 2"  
**Belt Speed:** 23 metres per minute  
**Capacity:** (L) 120 mm - (W) 150 mm - 500 mm  
(H) 120 mm - 500 mm  
**Power Supply:** 100 / 110 / 220 / 230 / 240 V.,  
50 Hz / 60 Hz., 1-Phase  
**Power Consumption:** 450 w

### EXC-138SDF Automatic Carton Sealing Machine

#### Major features

Case Flaping Closer

#### Option

3" Tape Head

infeed/outfeed Safety Guard

infeed/outfeed Roller Table

stopper (Indexer)

Tape Out Detector

cushion Side Belt

#### specification

tape Width 1 1/2", 2"

Belt Speed 23 Meters/minute

Capacity (L) 120mm ~ 610mm

(W) 110mm ~ 500mm

(H) 120mm ~ 500mm

Power Supply : 100/110/220/230/240v, 50hz/60hz, 1-phase

Power Consumption : 450w



## Contact Us:

### **SEASON INTERNATIONAL TRADING & INDUSTRIES CO. (SITCO) Bahrain**

Sitra Industrial Area,  
Entrance No. 3, Building 477,  
Road 109, Block 601  
P.O. Box 886, Manama  
Kingdom of Bahrain  
**T:** +973 (17) 704 647  
**F:** +973 (17) 704 648  
**E:** info@sitco.com.bh  
**W:** www.seasoninternational.net

### **GS PACKAGING Dammam**

Port Gate Building, Office & Showroom # 4  
Dammam / King Abdul-Aziz Port Road  
P.O. Box 10868, Dammam 31443  
Kingdom of Saudi Arabia  
**T:** +966 (13) 847 3734 / 8473735  
**F:** +966 (13) 847 3740  
**E:** info@gspackaging.net  
Sales@gspackaging.net  
**W:** www.gspackaging.net

### **GS PACKAGING Riyadh**

First Floor/Mosque Qhairy Building.  
Opp. SAPTCO. Aziziya.  
P. O. Box. 235789, Riyadh 11332.  
Kingdom of Saudi Arabia.  
**T:** +966 (11) 455 9914  
**F:** +966 (11) 438 9061  
**E:** info@gspackaging.net  
Sales@gspackaging.net  
**W:** www.gspackaging.net

### **GS PACKAGING Jeddah**

Office 202, Old Makkah Road, Kilo 3  
P.O. Box 33157, Jeddah 21448  
Kingdom of Saudi Arabia  
**T:** +966 (12) 602 0241  
**F:** +966 (12) 602 0167  
**E:** info@gspackaging.net  
Sales@gspackaging.net  
**W:** www.gspackaging.net

### **SEASON LEAD EDGE PAPER INDUSTRIES CO. W.L.L Bahrain**

Sitra Industrial Area,  
Entrance No. 3, Building 477,  
Road 109, Block 601  
P.O. Box 886, Manama  
Kingdom of Bahrain  
**T:** +973 (17) 704 647  
**F:** +973 (17) 704 648  
**E:** info@season-leadedge.com  
**W:** www.season-leadedge.com

### **SEASON INTERNATIONAL TRADING Oman**

P.O. Box 68, Rusayl  
Postal Code 135  
Sultanate of Oman  
**T:** +968 2236 7899  
**F:** +968 2236 7899  
**E:** info-oman@sitco.com.bh  
**W:** www.seasoninternational.net



SCAN TO FIND OUT MORE