

# BUILDING CODE TRAINING

---

Residential Thermal Envelope – Air Sealing

Presenters:     Joey Starr  
                  Elizabeth Karlsson

# ABOUT SOUTHFACE



*Building a Regenerative Economy, Responsible Resource Use  
& Social Equity Through a Healthy Built Environment for All*

# PRESENTERS



Joey Starr  
Education



Elizabeth Karlsson  
Technical Services



# ENERGY CODE RESOURCES

**Online educational resources are available by visiting:**

[www.southfaceonlinetraining.org](http://www.southfaceonlinetraining.org)

Technical assistance or training requests can be submitted to

**Georgia Energy Code Hotline at:** [energycodes@southface.org](mailto:energycodes@southface.org) or 404-604-3598

## **Additional Resources**

Georgia Energy Code: If you would like additional information on Georgia's current energy code, please visit the Georgia Department of Community Affairs website at: [www.dca.ga.gov/development/ConstructionCodes/programs/EnergyCodeTrainingWorkshops.asp](http://www.dca.ga.gov/development/ConstructionCodes/programs/EnergyCodeTrainingWorkshops.asp)

DOE Field Study: If you would like additional information on other DOE Field Studies and participating states, please visit the Building Energy Codes website here:

<https://www.energycodes.gov/compliance/energy-code-field-studies>

Georgia Field Study: If you would like further information regarding the Georgia Energy Code Field Study, please visit our project webpage found at: [www.seealliance.org](http://www.seealliance.org)

Tools Available: Commercial Field Guide, Pre-drywall Inspection video, webinars

<https://www.southface.org/resources/georgia-energy-code-resources/>

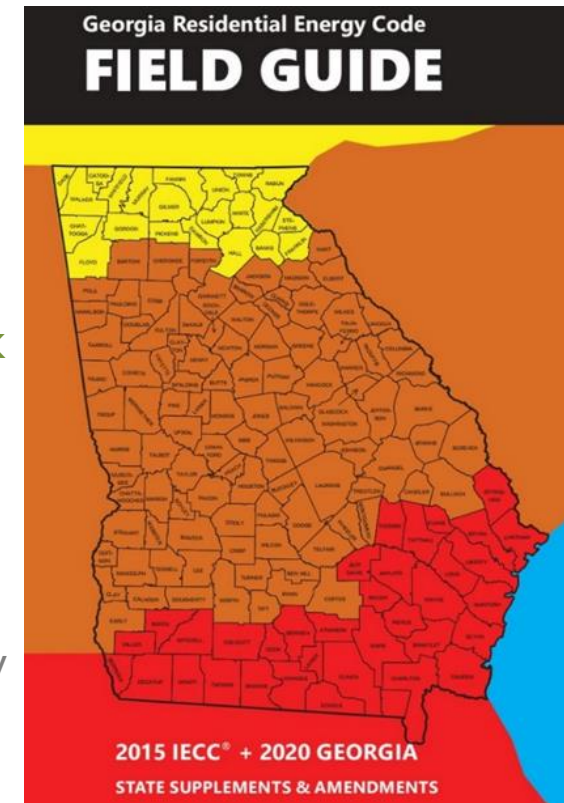

# LEARNING OBJECTIVES

---

- Understand Georgia State Minimum Standard Energy Code air barrier requirements
- Learn thermal boundary requirements of the Georgia energy code
- Identify house air sealing key points

# IMPORTANCE OF ENERGY CODES

**Saves energy** - Buildings consume 40% of energy in U.S.

**Saves money** - Energy costs continue to escalate and energy codes help keep money within local economy

## **Additional benefits:**

- Increases comfort, health and durability of homes
- Increases value of homes in local community
- Reduces liability for builders and subcontractors

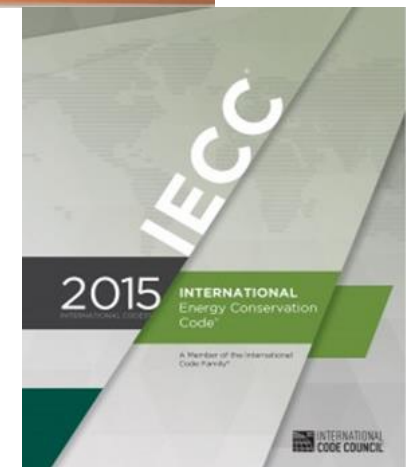
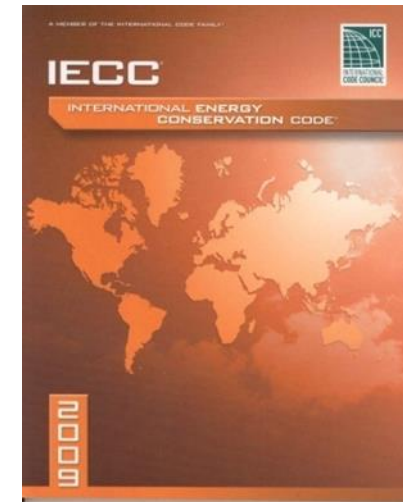

# SCOPE OF RESIDENTIAL ENERGY CODE

- Heavy focus on building thermal envelope
  - Ceilings, walls, windows, floors, foundations
  - Sets insulation levels, window U-factors and SHGC
  - **Infiltration control (Mandatory)**
    - Caulk and seal to prevent air leaks
    - Verify tight envelope with blower door AND visual inspection
- Ducts
  - No building cavities as ducts
  - Seal properly and insulate
  - Verify tight with duct pressurization test
- Hot water pipe insulation
- Lighting - high-efficacy bulbs required
- No appliance requirements

**RESIDENTIAL ENERGY EFFICIENCY**

**R-902.4 Air Leakage (Mandatory).** The building thermal envelope shall be constructed to limit air leakage in accordance with the requirements of Section R902.4.1 through R902.4.4.

**R902.4.1 Building thermal envelope.** The building thermal envelope and canopy shall comply with Sections R902.4.1.1 and R902.4.1.2. The seal up methods between the envelope and the foundation shall be in accordance with the requirements of Section R902.4.1.3.

**R902.4.1.1 Installation.** The components of the building thermal envelope shall be installed in accordance with the manufacturer's instructions and the criteria listed in Table R902.4.1.1, as applicable to the method of construction. Where required by the code official, an approved third party shall perform all components of the seal up.

**R902.4.1.2 Testing.** The building envelope seal up shall be tested and verified in accordance with the requirements of Section R902.4.1.2.1 and R902.4.1.2.2. Testing shall be conducted in accordance with ASTM E 779 or ASTM E 1827 and reported at a minimum to the code official. The test shall be conducted by the party conducting the seal up and provided to the code official. Testing shall be performed in any time after completion of all penetrations of the building thermal envelope.

**Exceptions:**

1. Doors, vestibules, entry vestibules, and exterior doors shall be tested in accordance with the manufacturer's instructions.
2. Egress and service openings shall be tested in accordance with Section R902.4.1.2.2.

**R902.4.2 Minimum fenestration U-factor and SHGC (Mandatory).** The uncoated fenestration U-factor and SHGC shall be in accordance with the requirements of Section R902.4.2.1 through R902.4.2.3. The fenestration U-factor and SHGC shall be in accordance with the requirements of Section R902.4.2.1 through R902.4.2.3.

**2018 INTERNATIONAL ENERGY CONSERVATION CODE®** R-23  
**INTERNATIONAL CODE COUNCIL**

**RESIDENTIAL ENERGY EFFICIENCY**

**TABLE R902.4.1 AIR BARRIER AND INSULATION INSTALLATION**

COMPONENT	INSULATION INSTALLATION CRITERIA
General requirements	The insulation shall be installed in accordance with the manufacturer's instructions. The insulation shall be installed in accordance with the manufacturer's instructions. The insulation shall be installed in accordance with the manufacturer's instructions.
Chimneys	The insulation shall be installed in accordance with the manufacturer's instructions. The insulation shall be installed in accordance with the manufacturer's instructions. The insulation shall be installed in accordance with the manufacturer's instructions.
Windows	The insulation shall be installed in accordance with the manufacturer's instructions. The insulation shall be installed in accordance with the manufacturer's instructions. The insulation shall be installed in accordance with the manufacturer's instructions.
Doors	The insulation shall be installed in accordance with the manufacturer's instructions. The insulation shall be installed in accordance with the manufacturer's instructions. The insulation shall be installed in accordance with the manufacturer's instructions.
Roofs	The insulation shall be installed in accordance with the manufacturer's instructions. The insulation shall be installed in accordance with the manufacturer's instructions. The insulation shall be installed in accordance with the manufacturer's instructions.
Basement walls	The insulation shall be installed in accordance with the manufacturer's instructions. The insulation shall be installed in accordance with the manufacturer's instructions. The insulation shall be installed in accordance with the manufacturer's instructions.
Attic	The insulation shall be installed in accordance with the manufacturer's instructions. The insulation shall be installed in accordance with the manufacturer's instructions. The insulation shall be installed in accordance with the manufacturer's instructions.
Garage	The insulation shall be installed in accordance with the manufacturer's instructions. The insulation shall be installed in accordance with the manufacturer's instructions. The insulation shall be installed in accordance with the manufacturer's instructions.
Basement lighting	The insulation shall be installed in accordance with the manufacturer's instructions. The insulation shall be installed in accordance with the manufacturer's instructions. The insulation shall be installed in accordance with the manufacturer's instructions.
Shower and exterior wall	The insulation shall be installed in accordance with the manufacturer's instructions. The insulation shall be installed in accordance with the manufacturer's instructions. The insulation shall be installed in accordance with the manufacturer's instructions.
Interior doors	The insulation shall be installed in accordance with the manufacturer's instructions. The insulation shall be installed in accordance with the manufacturer's instructions. The insulation shall be installed in accordance with the manufacturer's instructions.
Windows	The insulation shall be installed in accordance with the manufacturer's instructions. The insulation shall be installed in accordance with the manufacturer's instructions. The insulation shall be installed in accordance with the manufacturer's instructions.
Interior doors	The insulation shall be installed in accordance with the manufacturer's instructions. The insulation shall be installed in accordance with the manufacturer's instructions. The insulation shall be installed in accordance with the manufacturer's instructions.

**2018 INTERNATIONAL ENERGY CONSERVATION CODE®** R-24  
**INTERNATIONAL CODE COUNCIL**



# GEORGIA STATE MINIMUM STANDARD ENERGY CODE

The Georgia Department of Community Affairs (DCA) used the 2015 IECC Code to develop the new code

**Georgia Amendments for Codes Effective January 1, 2020**

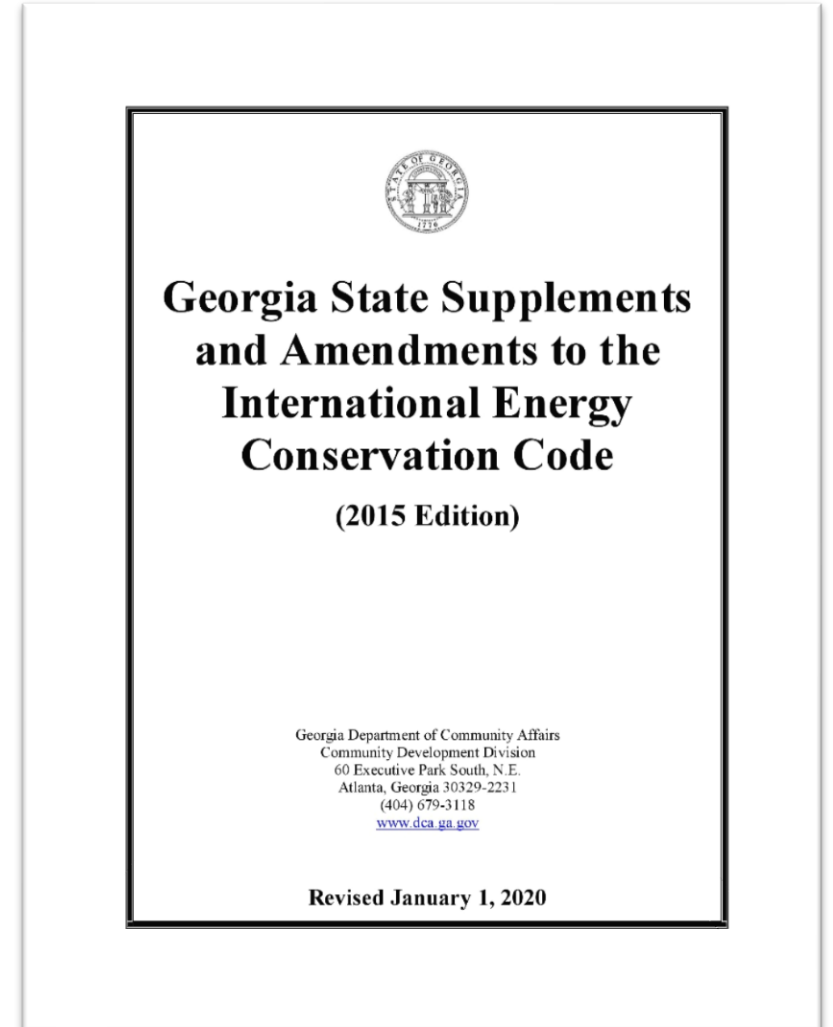



# 2015 GEORGIA RESIDENTIAL ENERGY CODE FIELD STUDY

## 8 Key Items :

- High-efficiency lighting
- **Envelope tightness (ACH50)**
- Duct leakage
- Exterior wall insulation
- Ceiling insulation
- Foundation insulation (floor / basement wall / slab)
- Window U-factor
- Window SHGC



U.S. DEPARTMENT OF  
**ENERGY** | Energy Efficiency &  
Renewable Energy

63 observations of each key item minimum

# ENVELOPE TIGHTNESS (ACH50)

Vertical red line indicates the IECC prescriptive code requirement of ~~7~~ **ACH50 5 ACH**

## Key Takeaways

Only 3 results worse than the 2009 IECC code of 73 tests conducted

The average ACH50 for all homes tested was 4.9

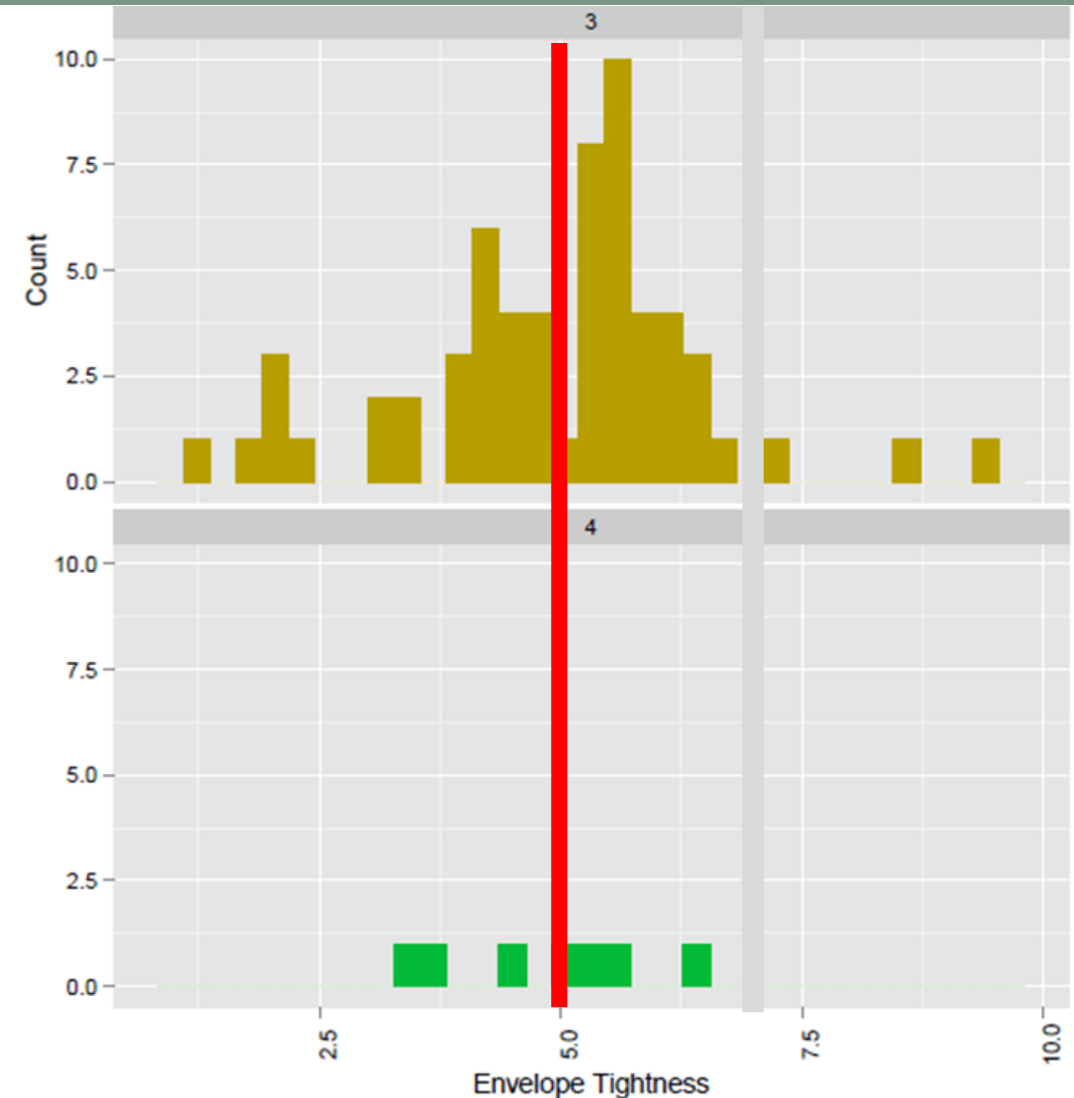

# DUCT AND ENVELOPE TIGHTNESS VERIFICATION

---

Third-party verifiers shall have one of the following minimum qualifications to conduct inspections or plan review for the energy efficiency provisions of residential buildings as defined by this code:

1. Accredited HERS Rater
2. ICC Residential Energy Inspector/Plans Examiner Certification
3. EarthCraft House Technical Advisor
4. Building Performance Institute (BPI) Analyst
5. Equivalent qualifications as approved by the local code official (Duct and Envelope Tightness Verifier)

# ENVELOPE TIGHTNESS EXAMPLE

$$ACH_{50} = \frac{CFM_{50} \times 60}{\text{Conditioned Volume}}$$

Blower Door Test: **1000 CFM<sub>50</sub>**

House Volume: **9600 ft<sup>3</sup>**

$$ACH_{50} = (1000 \times 60) / (9600)$$

$$ACH_{50} = \mathbf{6.25 \text{ FAIL}}$$

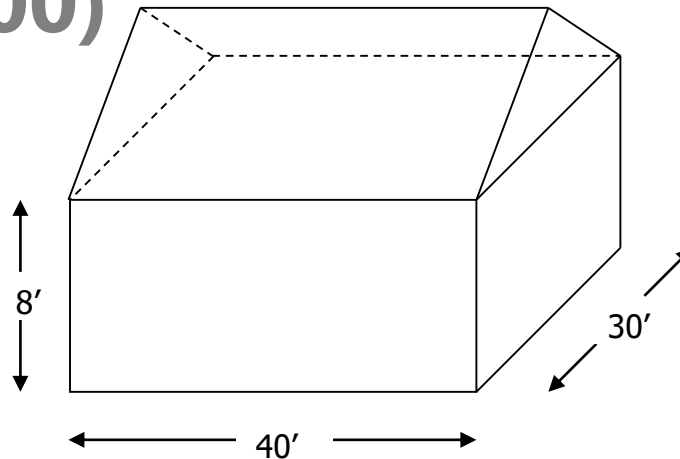

# ENVELOPE TIGHTNESS EXAMPLE

$$ACH_{50} = \frac{CFM_{50} \times 60}{\text{Conditioned Volume}}$$

Blower Door Test: **800 CFM<sub>50</sub>**

House Volume: **9600 ft<sup>3</sup>**

$$ACH_{50} = (800 \times 60) / (9600)$$

$$ACH_{50} = \mathbf{5 \text{ PASS}}$$

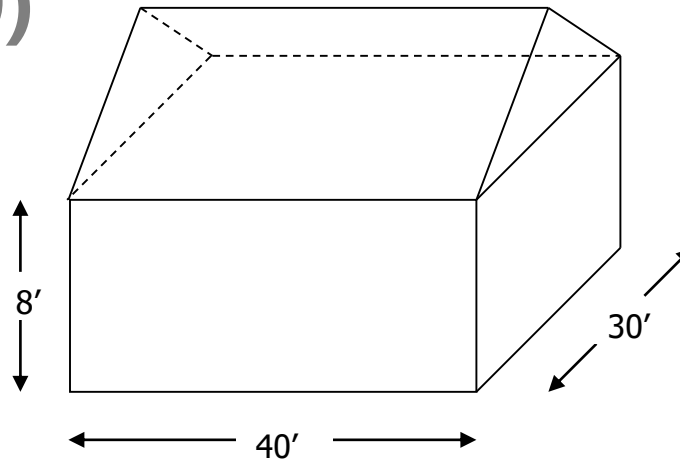



# ENVELOPE TIGHTNESS EXAMPLE

$$ACH_{50} = \frac{CFM_{50} \times 60}{\text{Conditioned Volume}}$$

Blower Door Test: **1000 CFM<sub>50</sub>**

House Volume: **12000 ft<sup>3</sup>**

$$ACH_{50} = (1000 \times 60) / (12000)$$

$$ACH_{50} = 5 \text{ PASS}$$

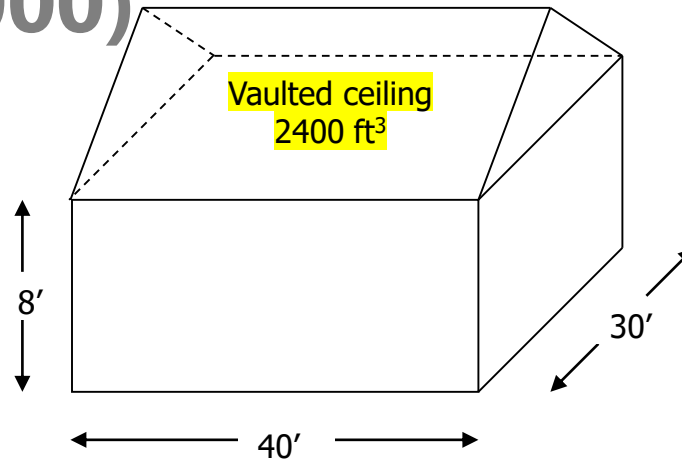

# BUILDING SCIENCE

---

Residential Building Code Training

# THE HOUSE AS A SYSTEM

A house is a system made up of interrelated parts:

- Space conditioning
- Ventilation
- Water heating & distribution
- Lighting & appliances
- The building thermal envelope

Building science represents a holistic view of a house and applies an understanding of the flow of: Heat, air and moisture

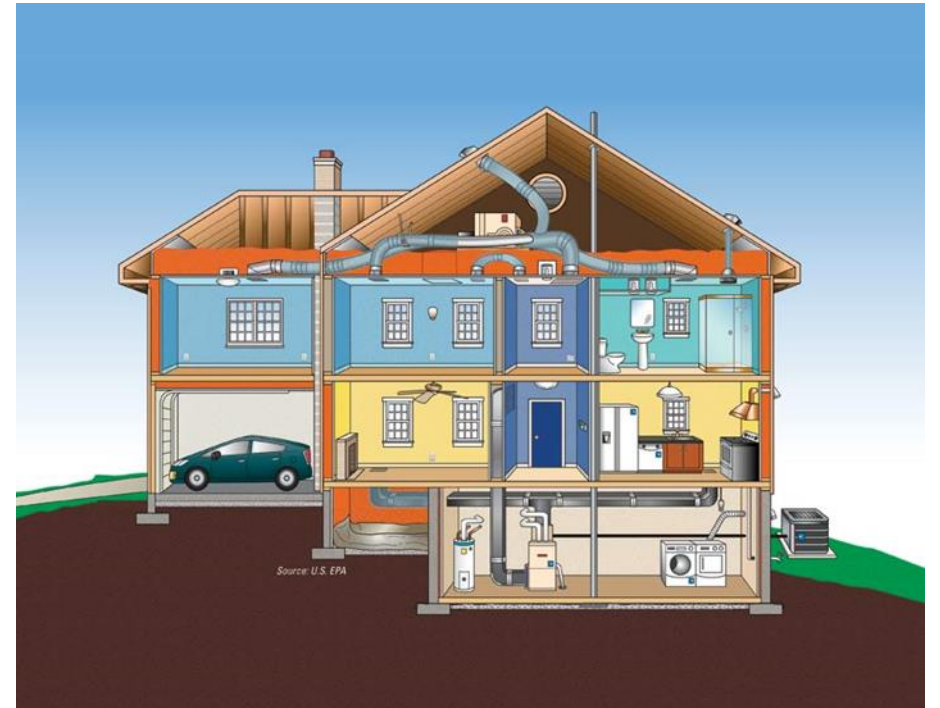

## SECTION R402 – BUILDING THERMAL ENVELOPE

The building thermal envelope is the barrier that separates conditioned space from unconditioned space.

The envelope should consist of a **continuous** thermal barrier (insulation) and an air barrier that are in contact.

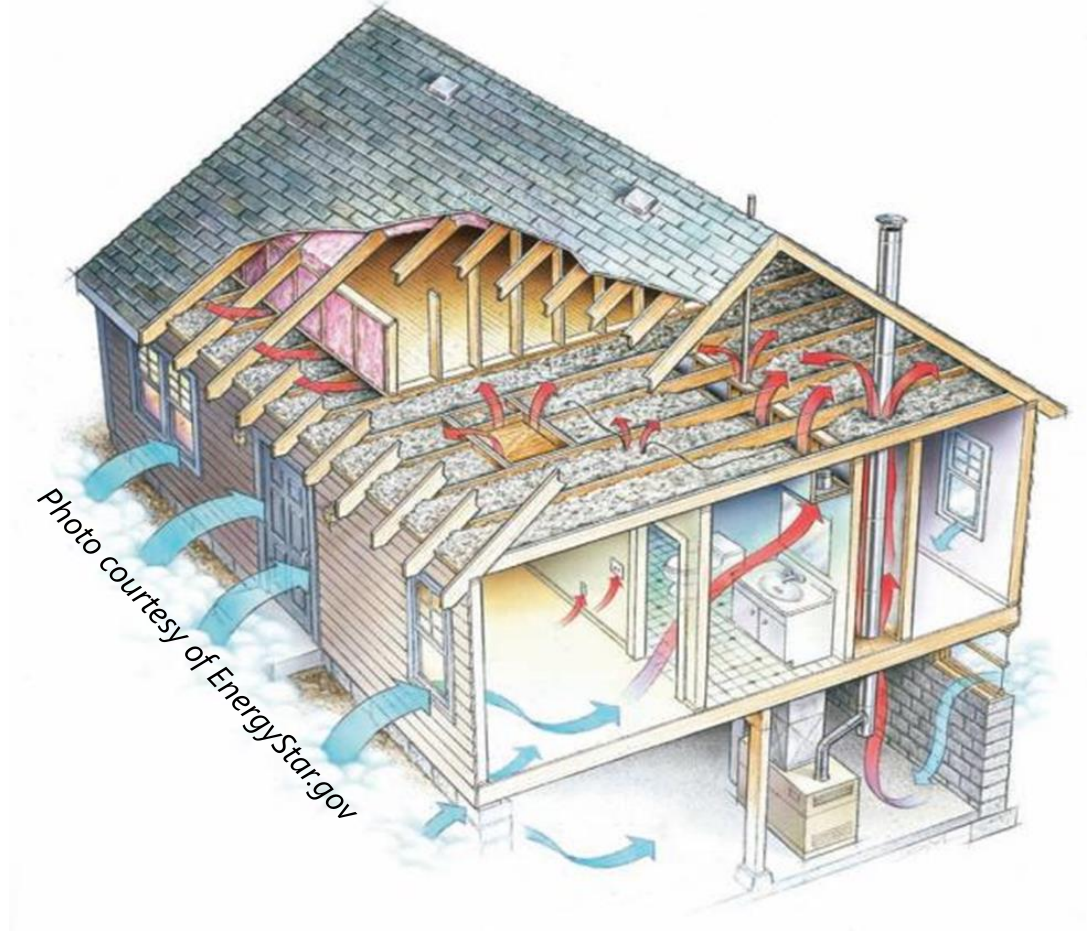



# CONDUCTION

- Heat moves through a material
- Insulation can slow down conduction
  - How well a material slows conduction is called resistance
  - Resistance is measure is R value or U value





# THERMAL BARRIER

- Limits heat flow between inside and outside.
- Easy to identify by presence of insulation.
- The location of insulation in relation to other building components is critical to its effectiveness.
- Even small areas of missing insulation are very important.
- Voids of 7% can reduce effective R-value by almost 50%.

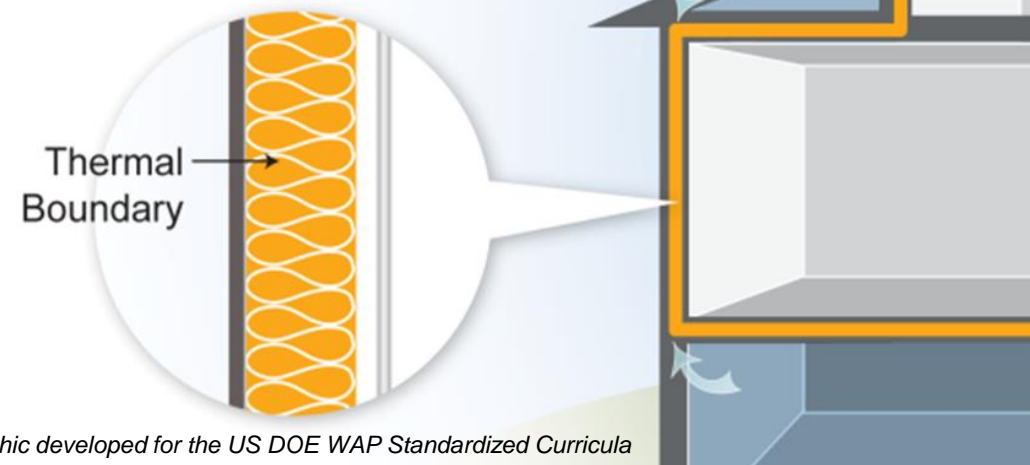

*Graphic developed for the US DOE WAP Standardized Curricula*

# CONVECTION

- Air moves from areas of higher pressure to areas of lower pressure
- Natural and man-made forces that can create pressure differences cause air to flow
- Whenever air moves out of a home, an equal amount of air enters the home

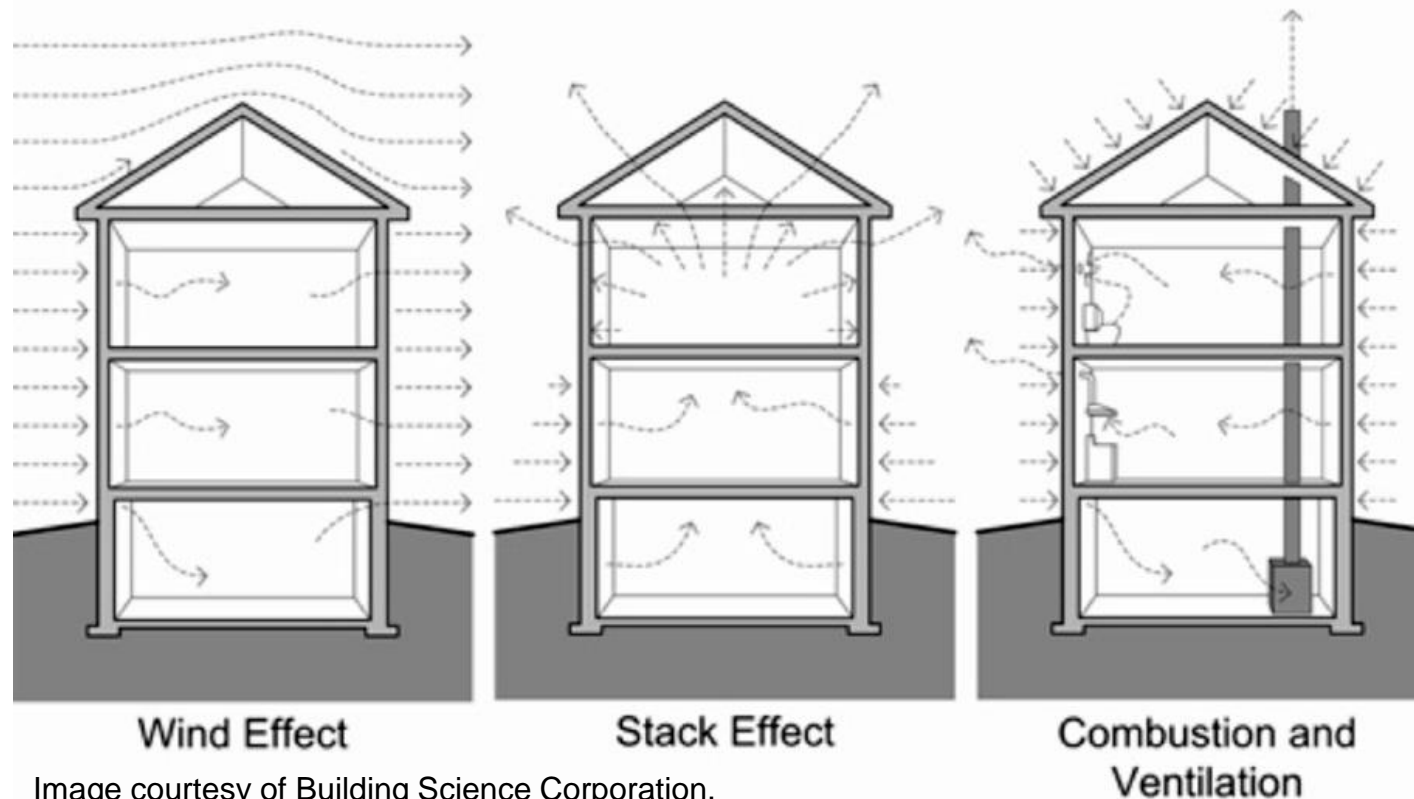
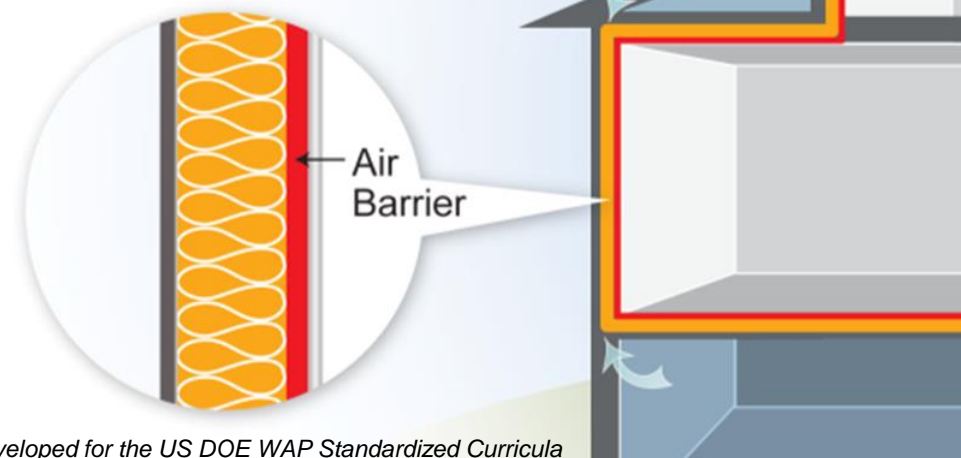

Image courtesy of Building Science Corporation,

# AIR BARRIER

- Limits airflow between inside and outside
- More difficult to identify
- Not always where you think it is
- Should be collocated with the thermal barrier
- Blower door is used to locate air barrier



*Graphic developed for the US DOE WAP Standardized Curricula*

# MOISTURE

Another reason to limit air flow in a home is to reduce moisture intrusion. Even a small hole can allow a large amount of water into the building.

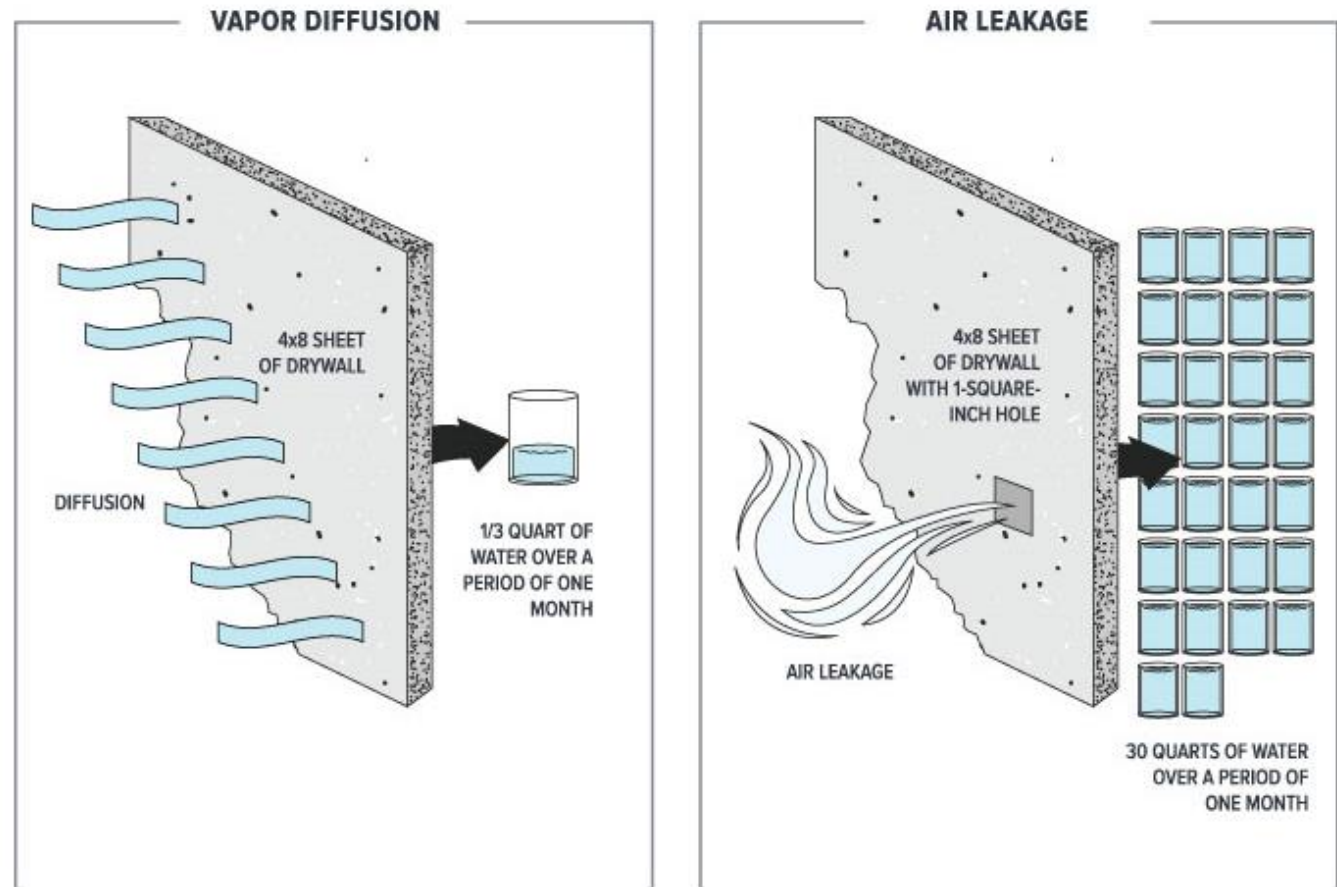

## VAPOR DIFFUSION VS. AIR LEAKAGE

INTERIOR TEMPERATURE = 70° F  
RELATIVE HUMIDITY = 40%

©CCPIA

# APPENDIX RA EXAMPLE

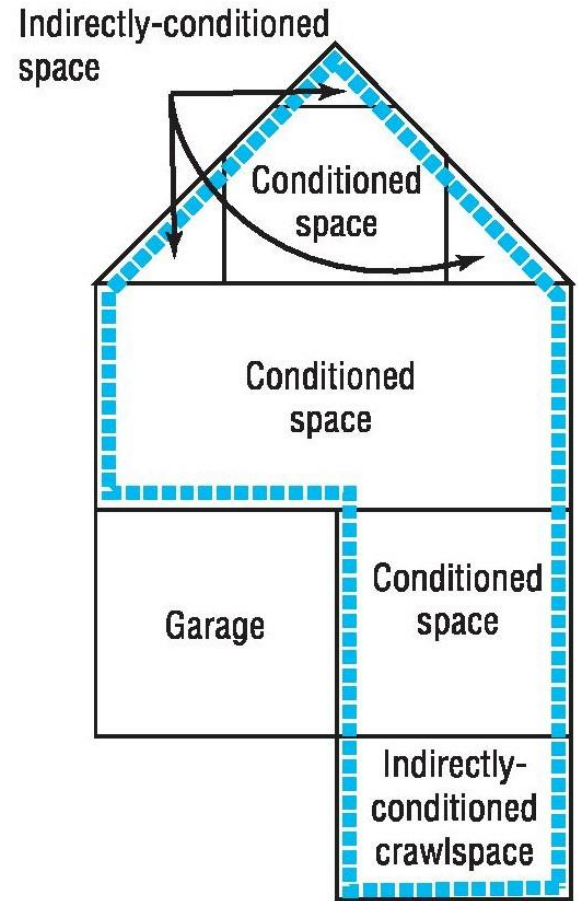
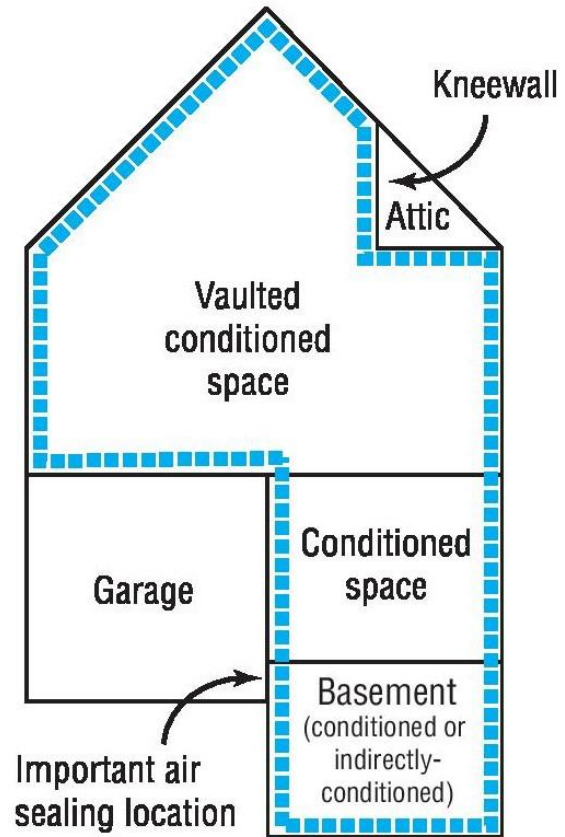
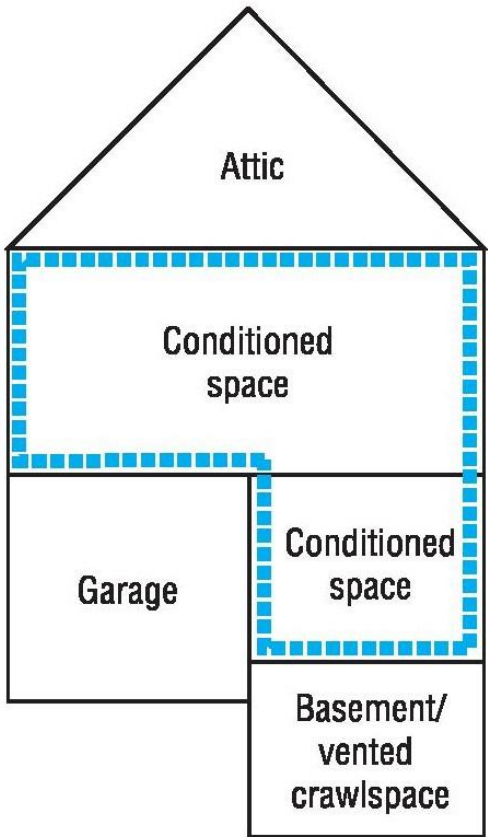

\*Although these three homes look identical from the outside, each has defined the building thermal envelope differently



## SPACE – GA DEFINITION

---

- a) **Conditioned space:** a cooled space, heated space, or indirectly conditioned space is defined as follows:
1. **Cooled space:** an enclosed space within a building that is cooled by a cooling system whose sensible output capacity exceeds 5 Btu/h·ft<sup>2</sup> of floor area.
  2. **Heated space:** an enclosed space within a building that is heated by a heating system whose output capacity relative to the floor area is greater than or equal to 5 Btu/h·ft<sup>2</sup>.
  3. **Indirectly conditioned space:**

## SPACE – GA DEFINITION (CONT.)

---

- 3. Indirectly conditioned space:** an enclosed space within a building that is not a heated space or a cooled space, containing un-insulated ducts, or containing the heating equipment or which is heated or cooled indirectly by being connected to adjacent space(s), provided that air from heated or cooled spaces is transferred (naturally or mechanically) into the space.

Unvented Attic Assemblies meeting the requirements of the IRC are an approved indirectly conditioned space.

## SPACE – GA DEFINITION (CONT.)

---

- b) Semi-heated space:** an enclosed space within a building that is heated by a heating system whose output capacity is greater than or equal to 3.4 Btu/h·ft<sup>2</sup> of floor area but is not a conditioned space.
- c) Unconditioned space:** an enclosed space within a building that is not a conditioned space or a semi-heated space. Crawl spaces, attics, and parking garages with natural or mechanical ventilation are not considered enclosed spaces.

# AIR BARRIER INSTALLATION

---

Residential Building Code Training

# ATTIC HATCHES

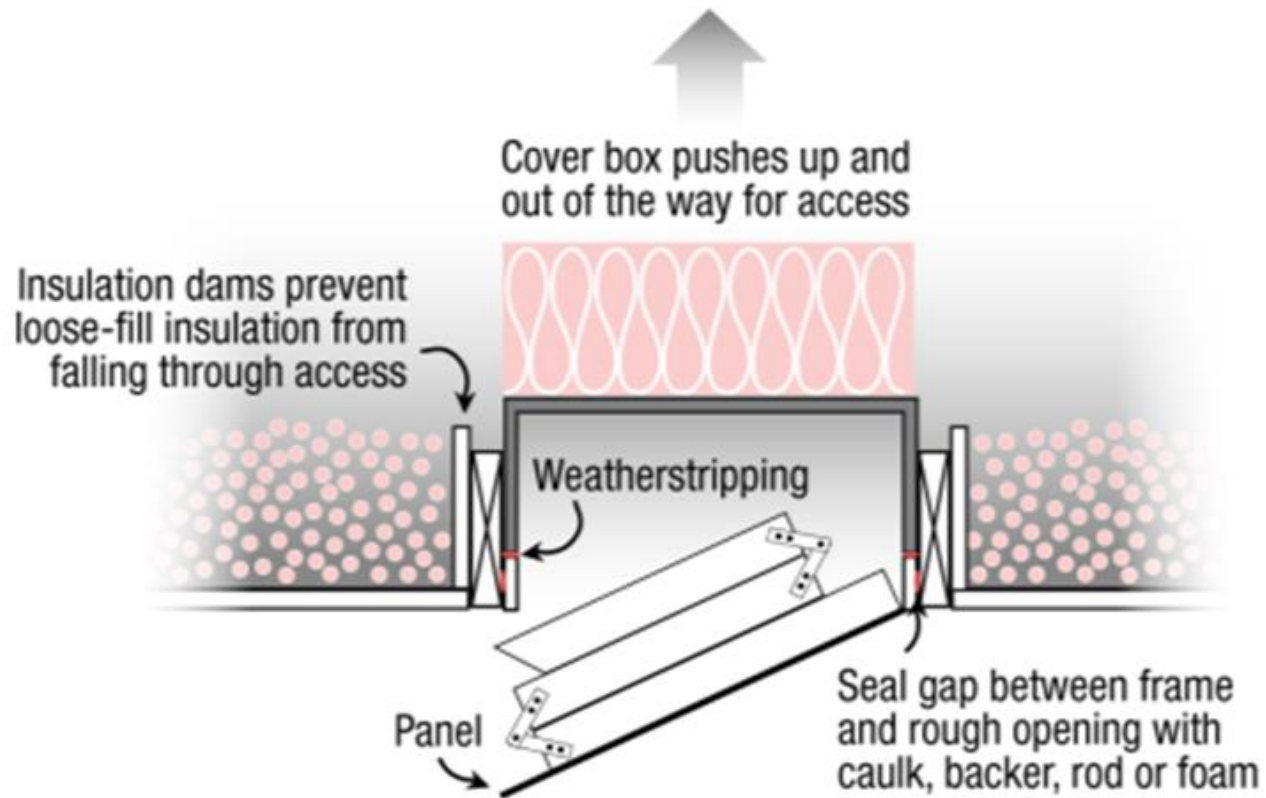

Graphic courtesy of <http://www.energysavers.gov>





# ATTIC HATCHES

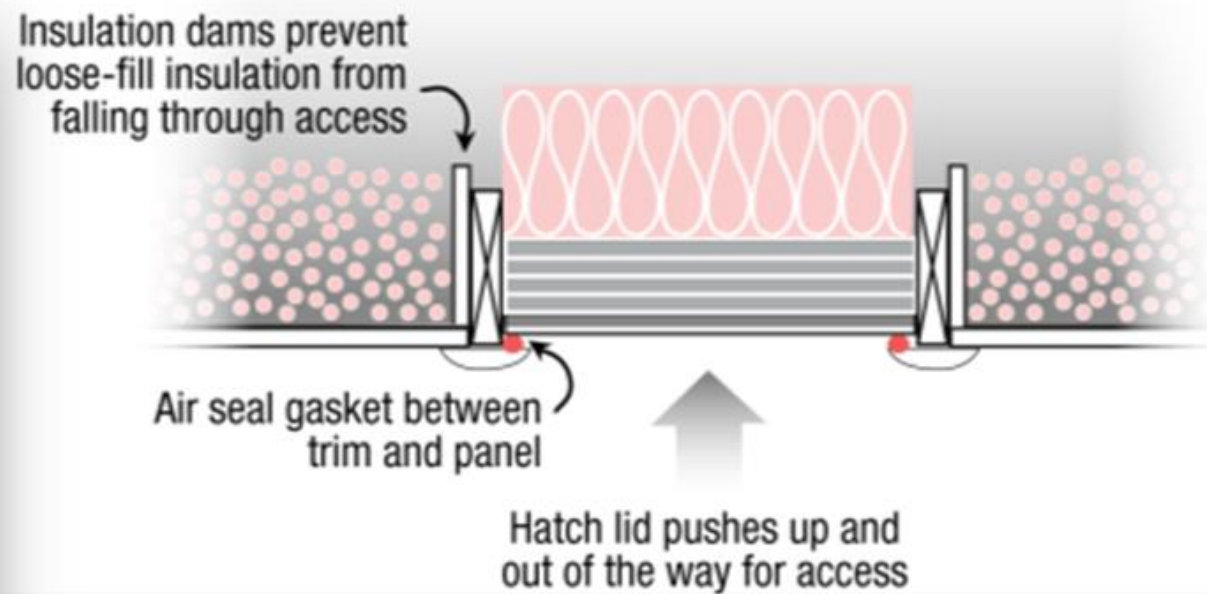

Graphic courtesy of <http://www.energysavers.gov>

# ATTIC DOORS

Vertical doors must have a minimum of R-5 and must be weatherstripped for air sealing

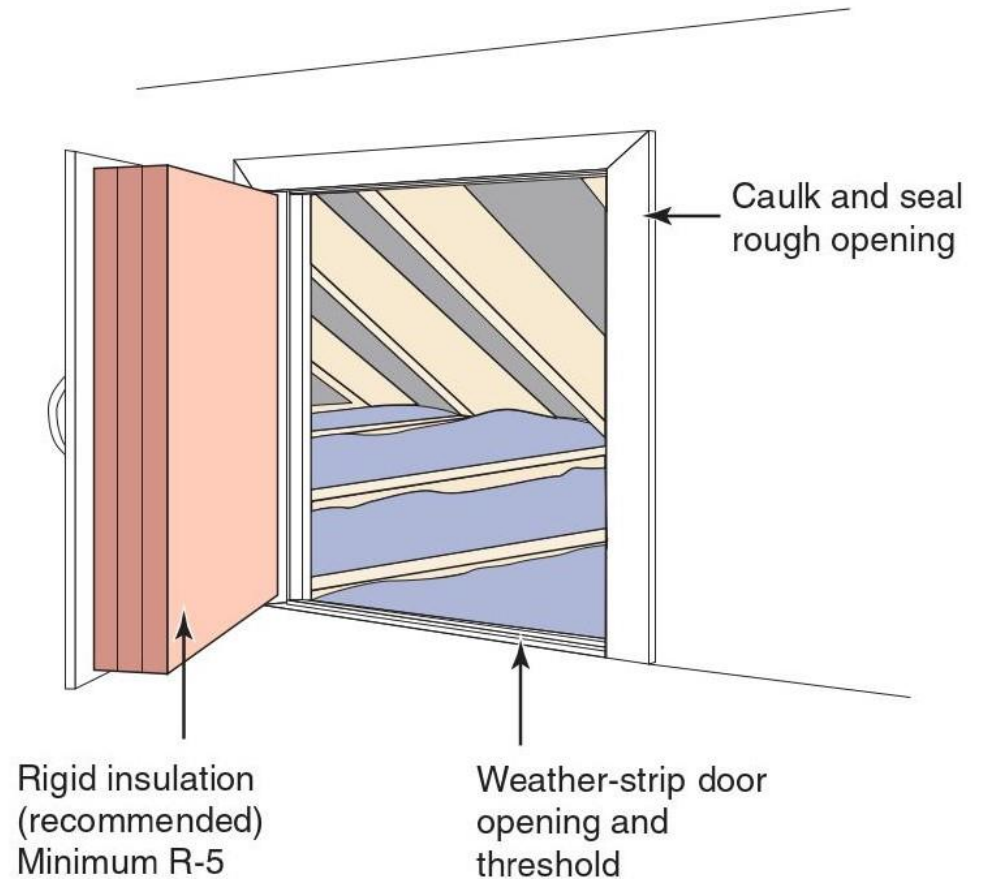

# AIR IMPERMEABLE INSULATION

Appendix RA

2015 IECC (2019 Georgia Energy Code)

## Roofline Installed Insulation Options

Reference Table 402.1.1 and 402.1.6 in the Georgia Energy Code amendments to the 2015 IECC and Section 806.5 “unvented attic assemblies” in the Georgia Amendments to the 2012 IRC

**Vaulted unvented attic –  
roofline air-impermeable insulation**  
(e.g., spray foam insulation)

Air impermeable insulation  
(e.g., open- or closed-  
cell spray foam)

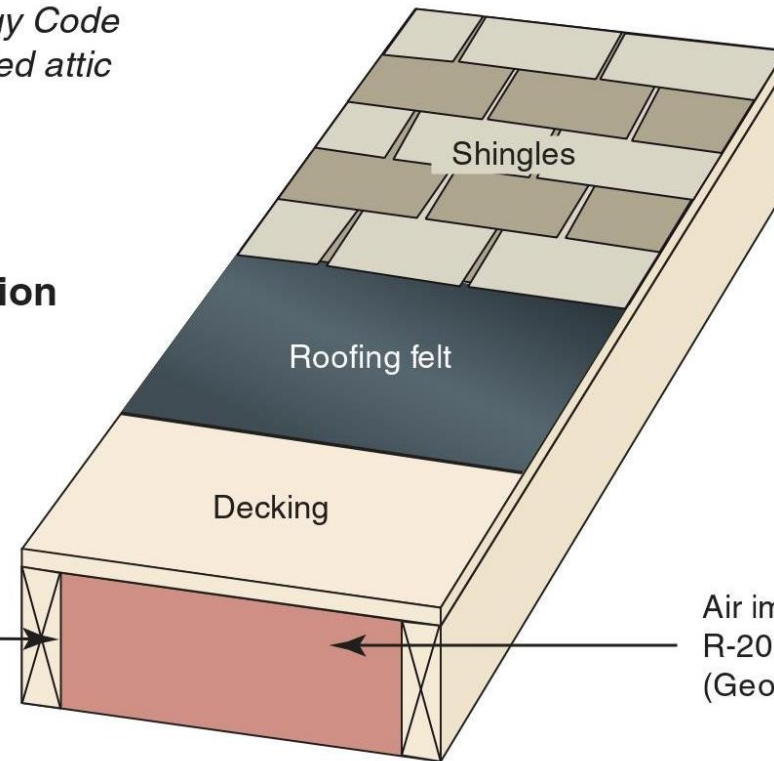

Air impermeable insulation  
R-20 minimum if trade-offs are used  
(Georgia requirements)

# SHOWER/TUB ON EXTERIOR WALL

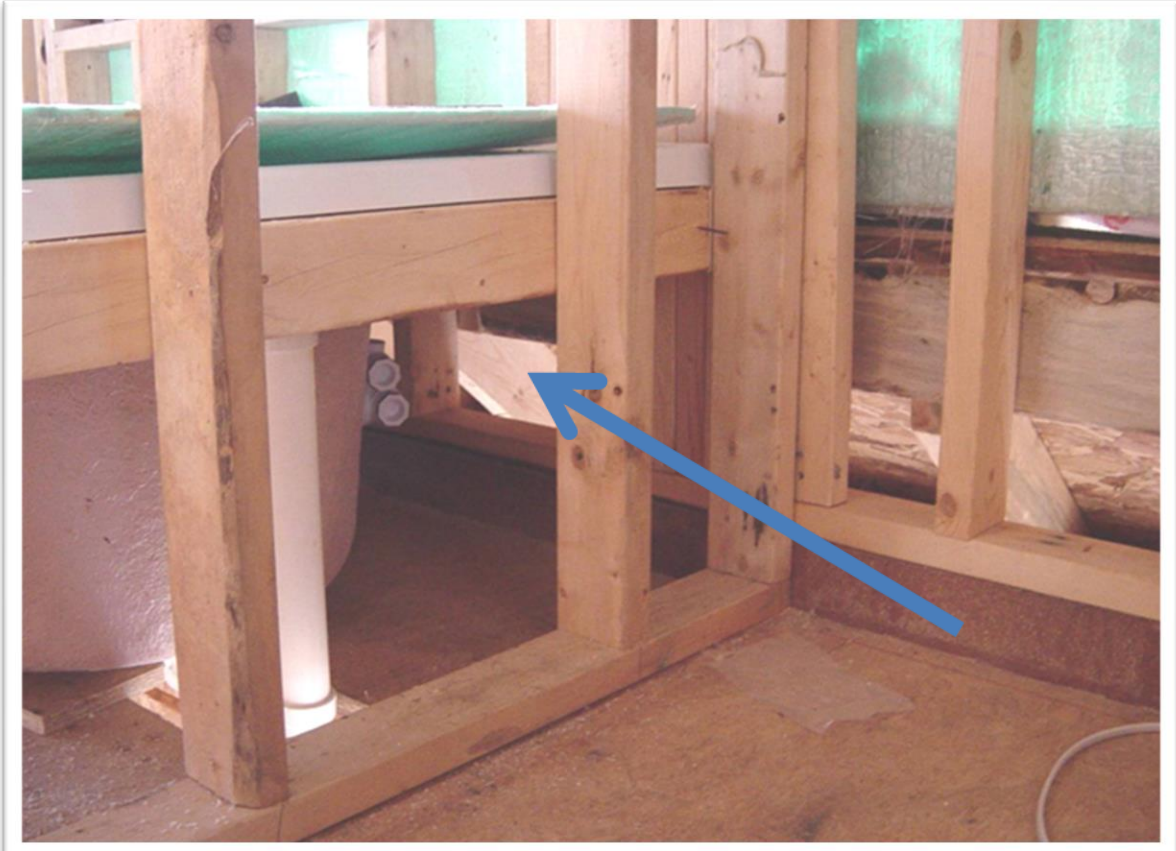



# SHOWER/TUB ON EXTERIOR WALL

Coordinate with your subcontractors so that insulation and air sealing details are not missed before it is too late!



# PLUMBING AND WIRING

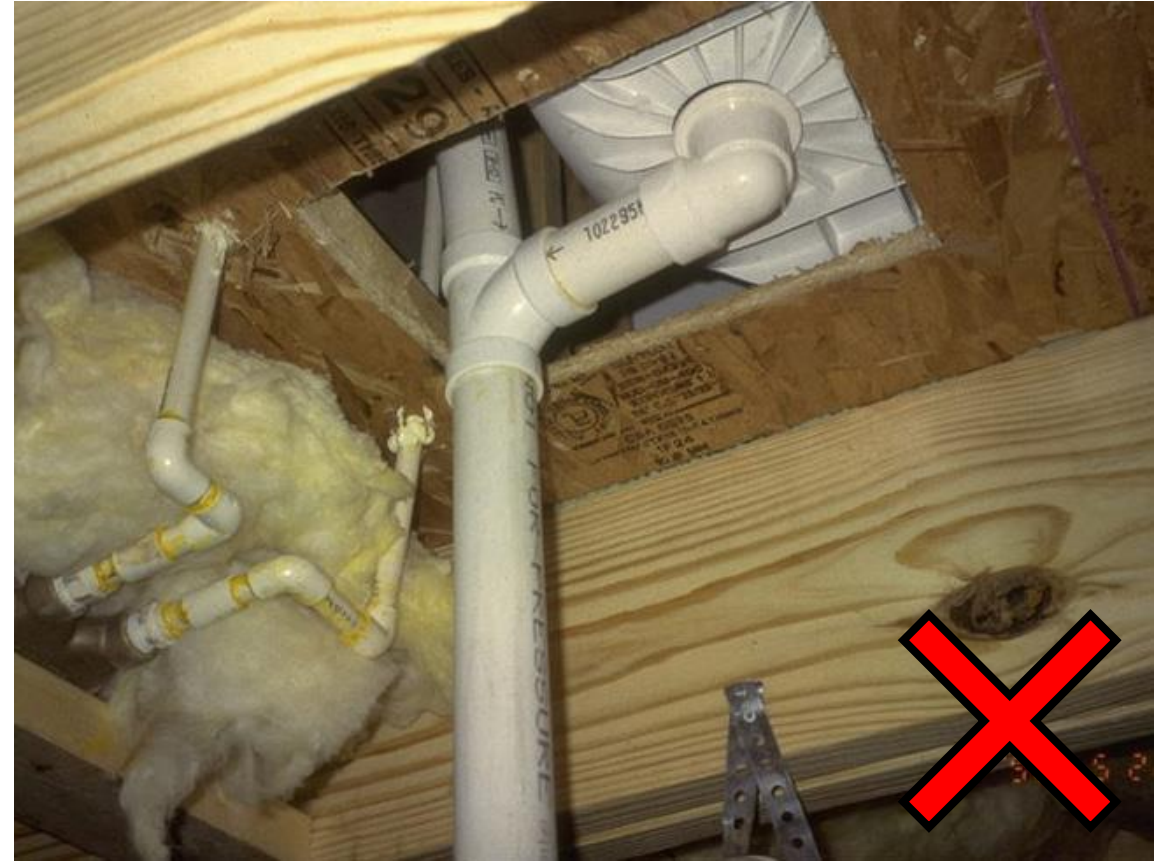
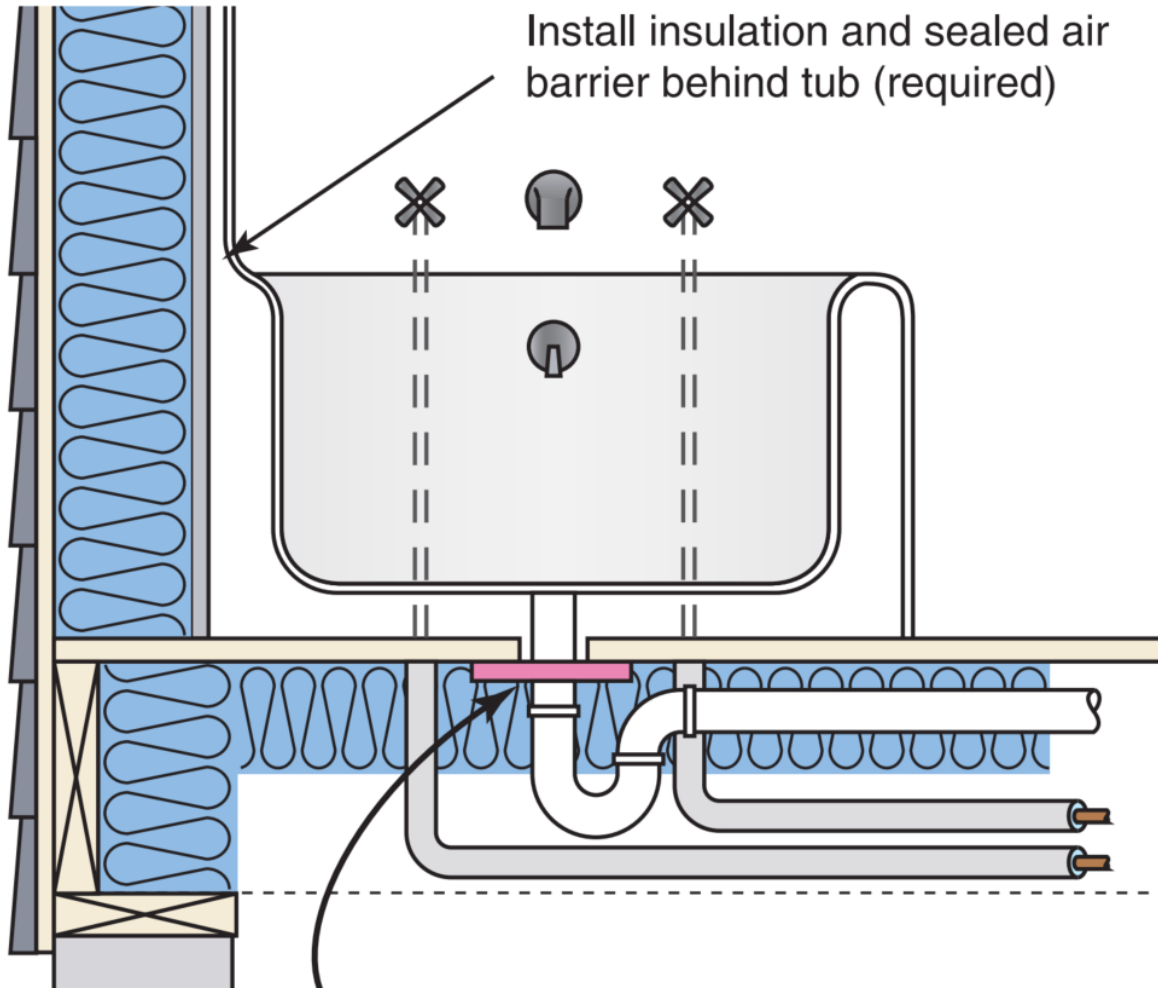



# CANTILEVERED FLOOR



Did not install blocking  
(Just Covered Over With Insulation)

Install expanding-foam sealant at perimeter gaps around rigid insulation.

Continuous bead of sealant

1½-in. rigid insulation

1½-in. rigid insulation with 3/8-in. gap for expanding foam

### Cantilevered floor

The blocking above the bearing wall helps to define the home's air barrier, so each piece of blocking needs to be sealed at the perimeter with caulk or canned spray foam. As long as both layers of rigid foam are installed with attention to airtightness, this type of cantilevered floor performs well.

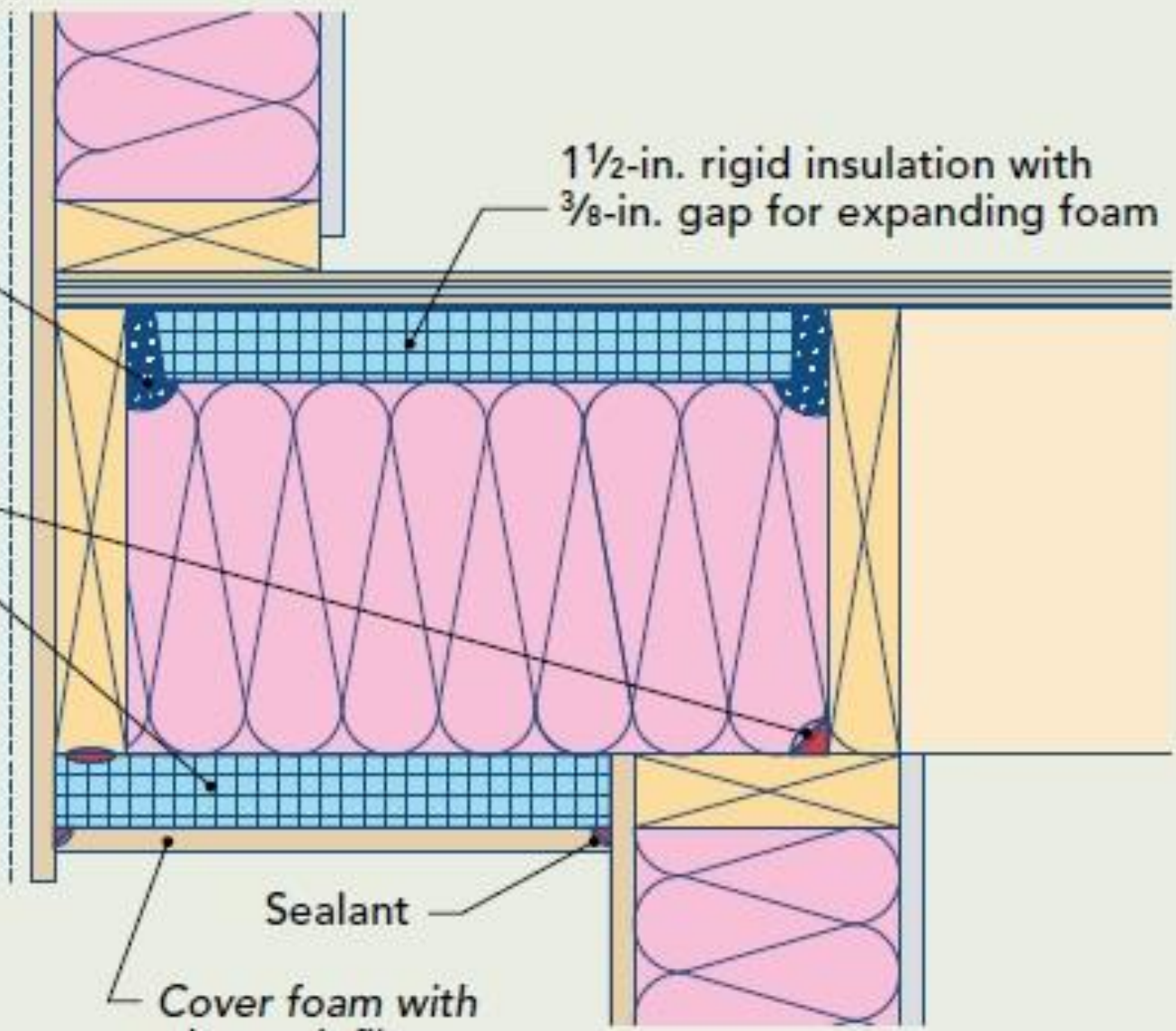

Sealant

Cover foam with plywood, fiber cement, or other solid soffit material.



# GARAGE SEPARATION





# GARAGE SEPARATION

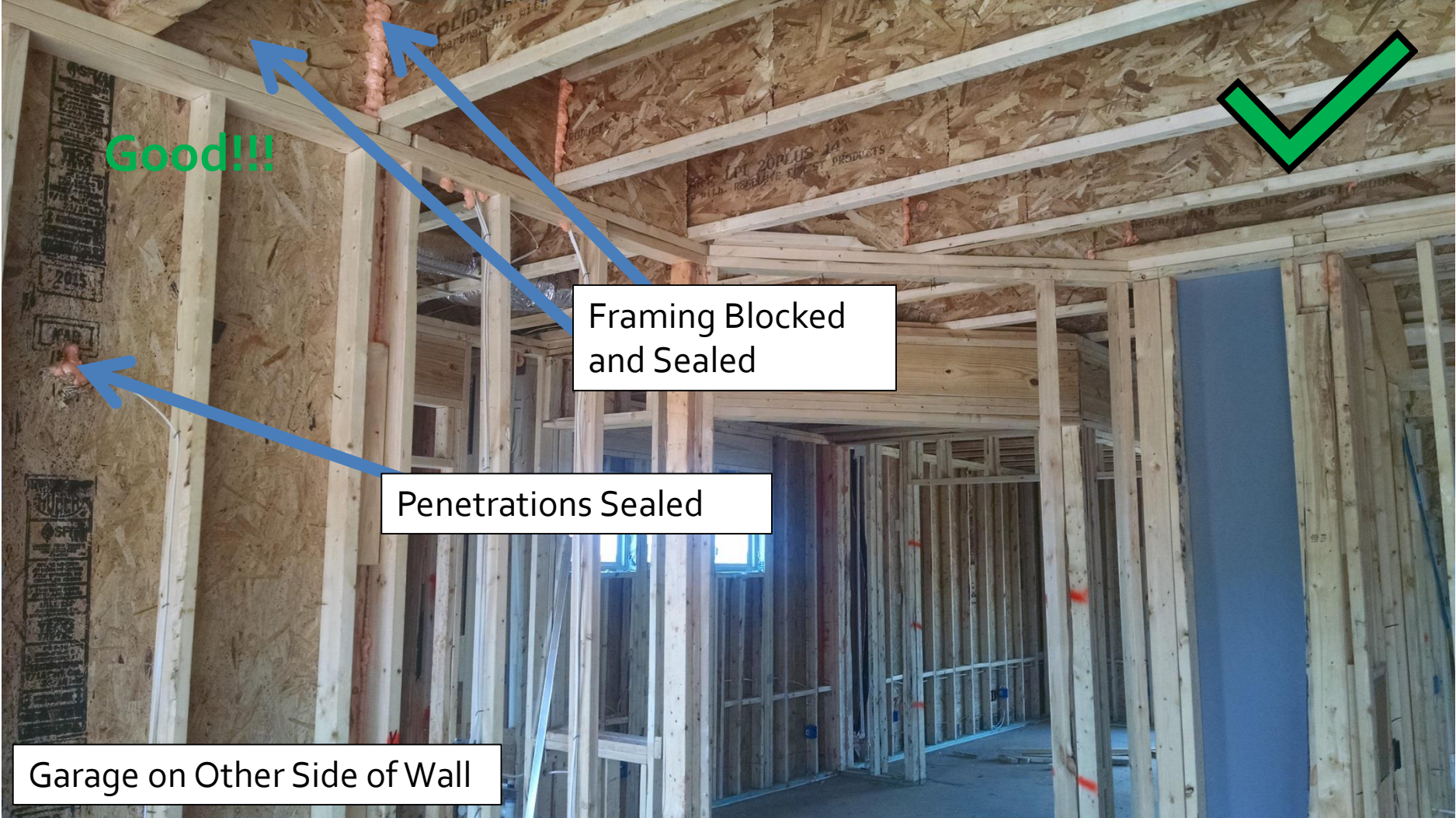

# DUCT SHAFTS

Cap chases with rigid material and seal tight around ducts or flue pipes





# DUCT SHAFTS

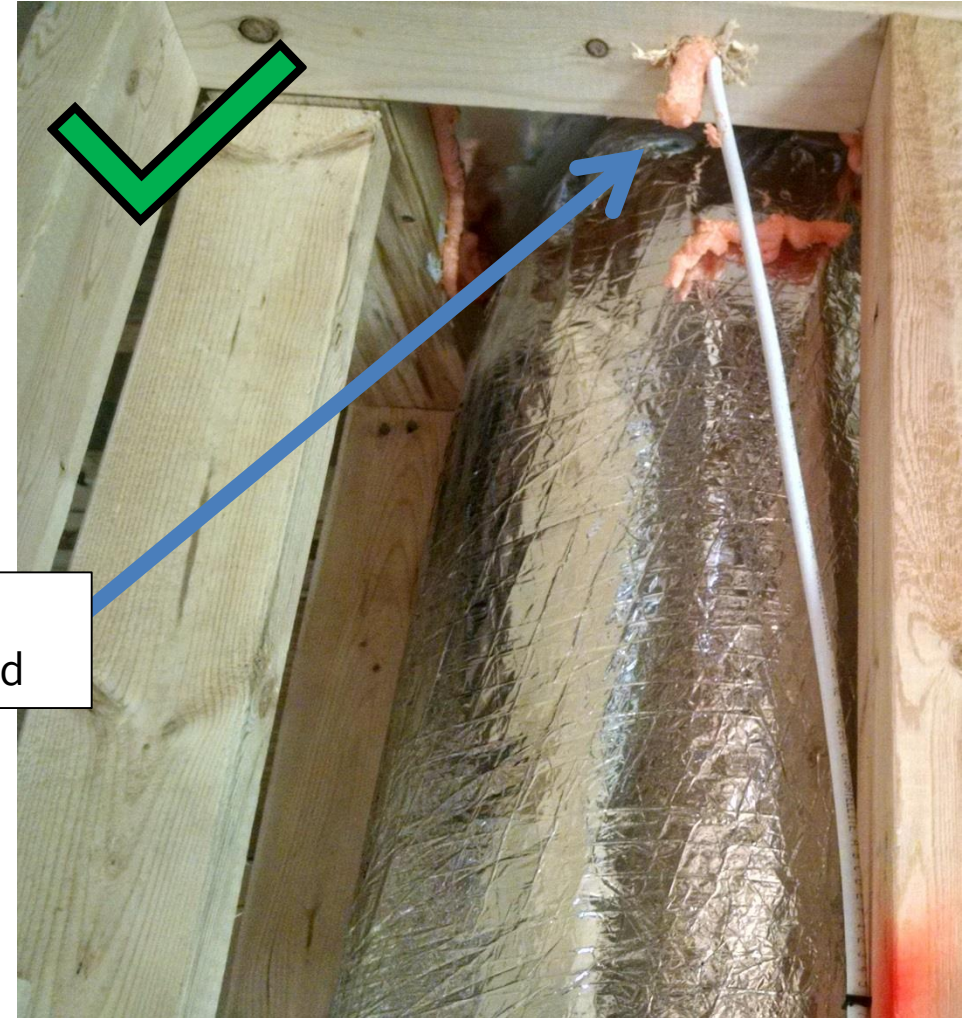
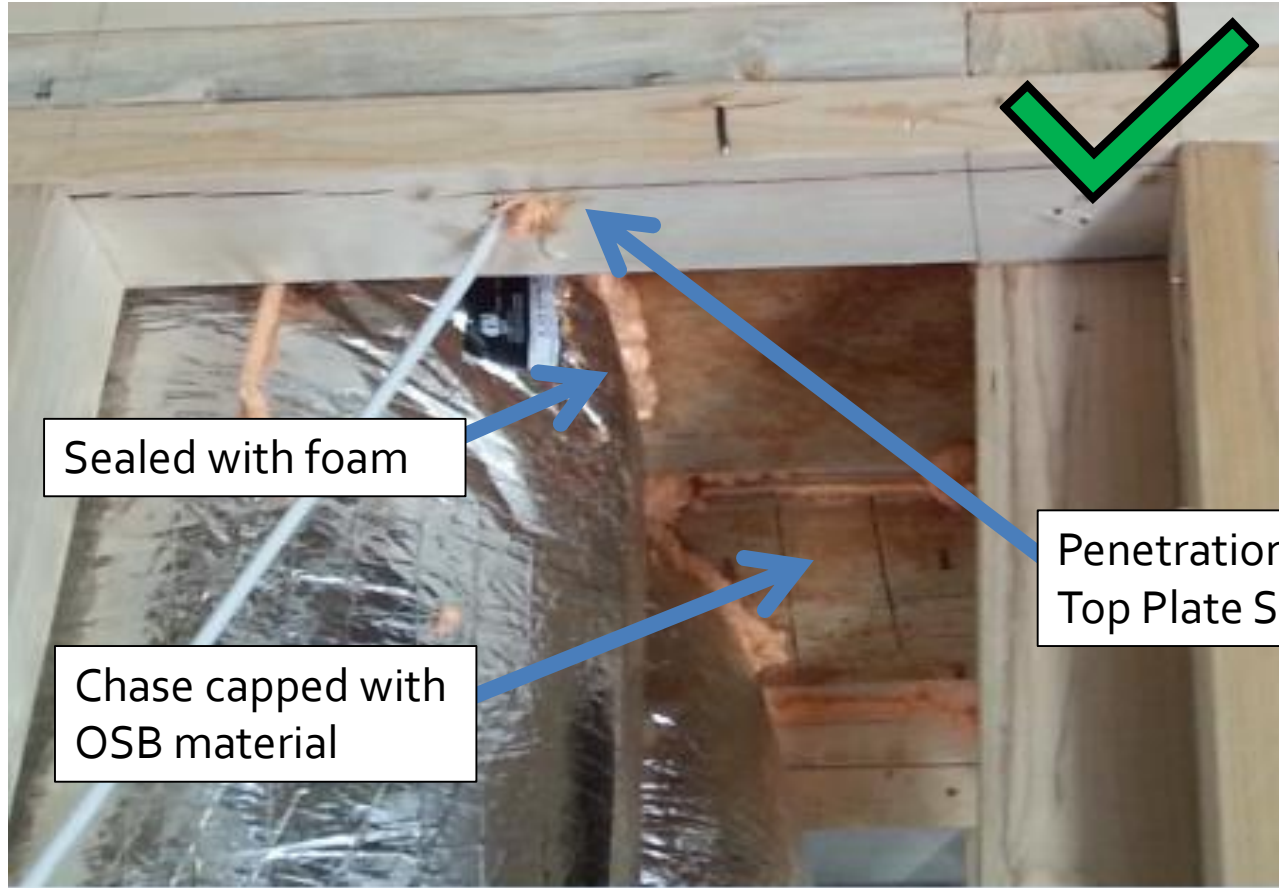



# PLUMBING AND WIRING PENETRATIONS

Penetrations opening to exterior or unconditioned space shall be sealed.

Use appropriate materials: caulking, foam, or mastic.



# KNEE WALLS



No blocking under kneewalls

Air permeable kneewall insulation needs to be encapsulated on **all** sides



# KNEE WALLS

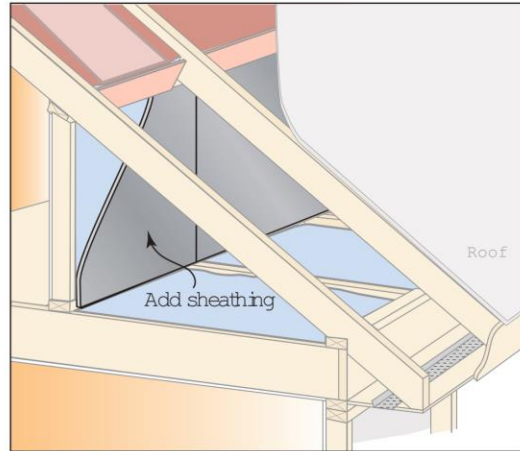
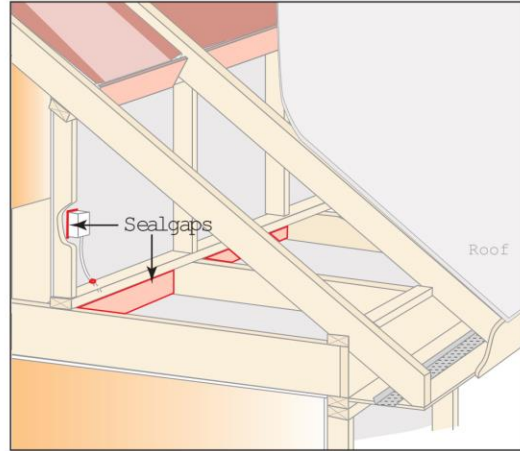
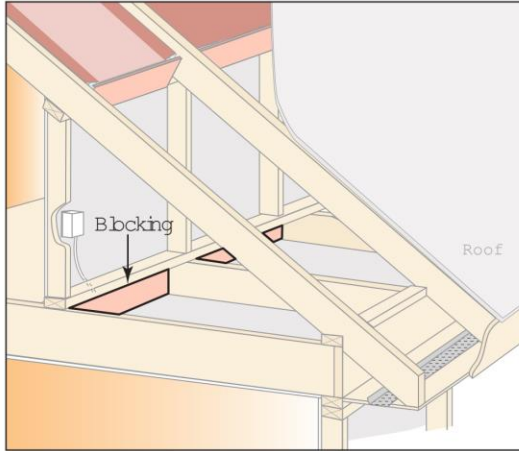

## 402.4.5 RECESSED LIGHTS

### Standard Can Light



### Airtight and IC Rated



- All recessed luminaires shall be labeled as having an air leakage rate not more than 2.0 cfm tested at 75 pa
- All recessed luminaires shall be sealed with a gasket or caulk between the housing and the interior wall or ceiling covering



# SILL (BOTTOM) PLATE

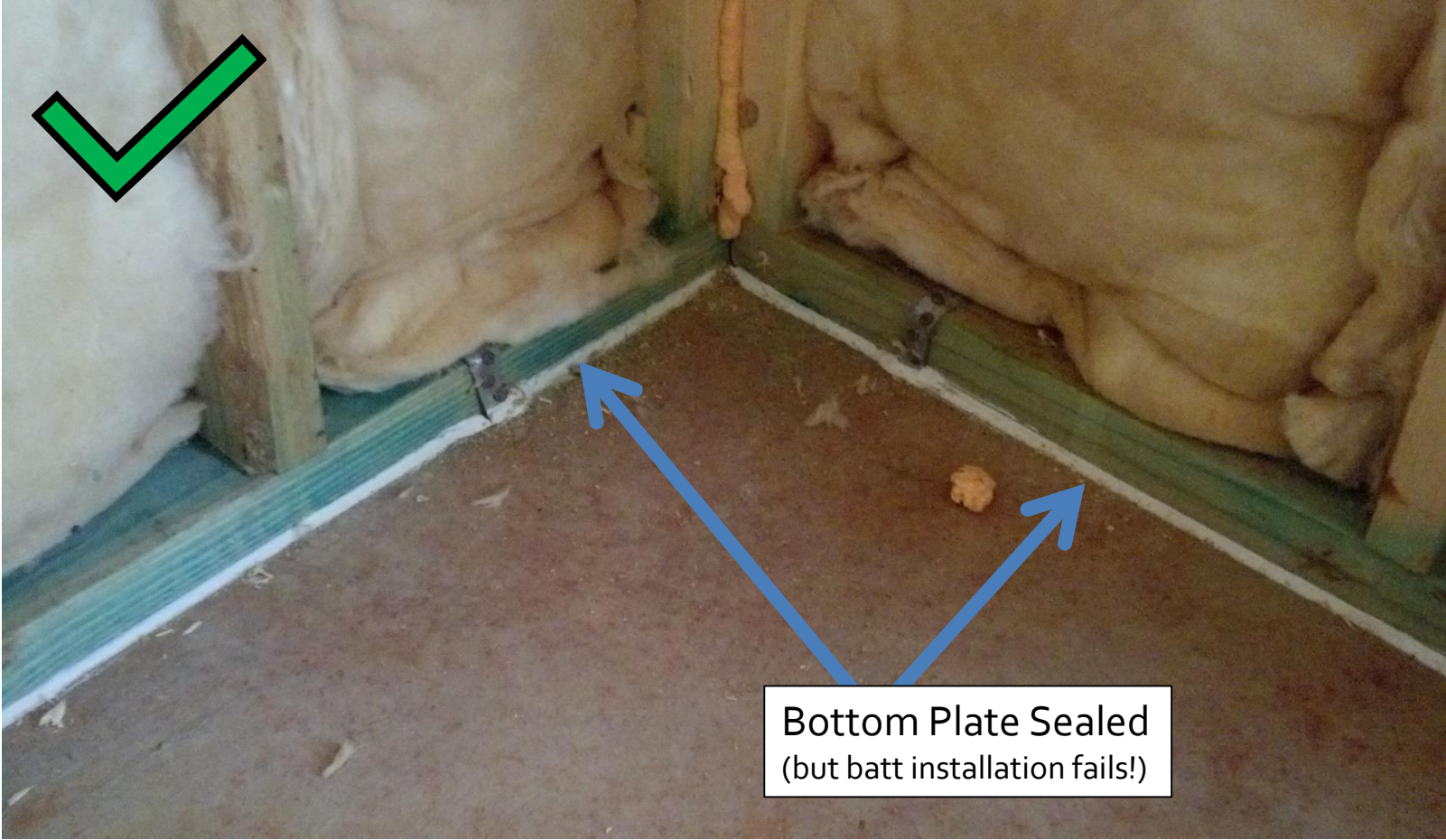

## SILL (BOTTOM) PLATE

Dirty carpet on **exterior** wall indicates leak at wall sill plate

On **interior** wall indicates wall leaking to attic





## R402.2.8 FLOORS

Floor insulation must maintain **permanent** contact with the subfloor.



# FLOOR INSULATION

## GOOD!

Installed insulation is in complete contact with air barrier (subfloor)

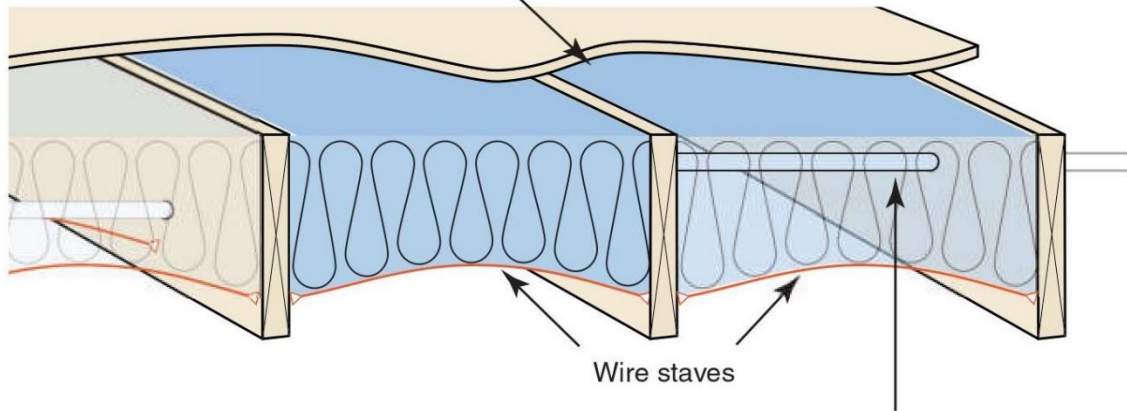

Insulation coverage is complete

Insulation is slit around plumbing and wiring and securely fastened with minimal compression

## BAD!

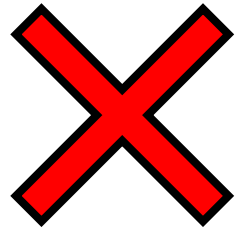

Insulation is not installed in complete contact with air barrier (subfloor)

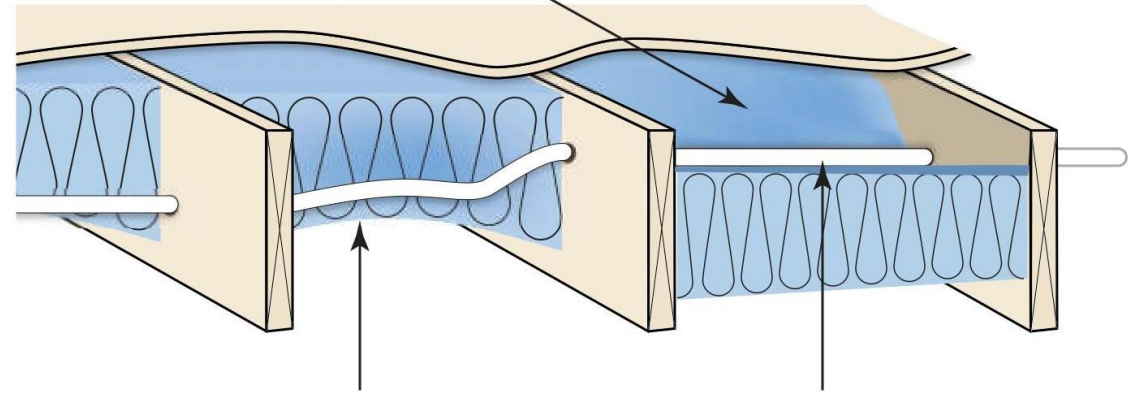

Insulation coverage is incomplete due to obstructions (plumbing, electrical, ductwork, etc.)

Insulation is compressed around plumbing and wiring and is not securely fastened

## R402.2.11 CRAWLSPACE WALLS

- Air seal & insulate band area
- 3-inch view strip (removable is option)
- Insulation must be permanently fastened and extend to within 9" of the finished interior grade
- Complete plastic sealed to walls at least 6 inches up the stem wall





# CRAWLSPACE WALLS

Southface suggestion: taped, hinged "plug" of rigid insulation board in gap



# BAND JOISTS

- Must air seal and insulate rim/band area in basements & crawlspaces
- Pest control industry struggles with band area fully filled with spray foam
- Blocks inspection for pest control
- Air seal and then insulate with movable insulation product (batts, pillows, rigid board, etc.)

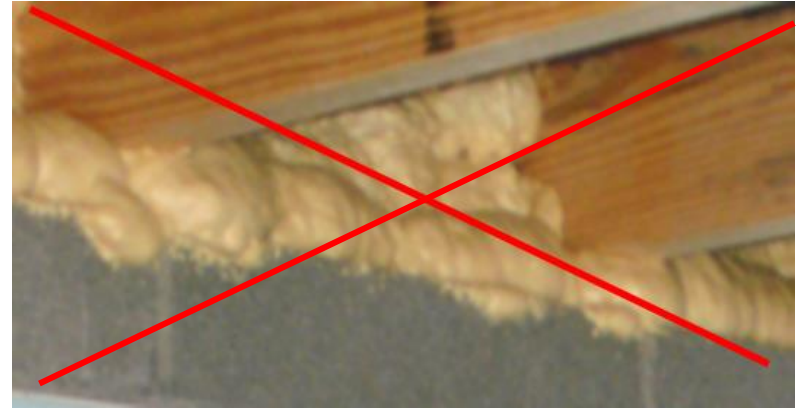

# ATMOSPHERICALLY VENTED APPLIANCES

Do **not** use atmospherically vented appliances in closed crawlspaces or attics.





# CRAWLSPACE VENTING

Satisfy IRC exception to vent requirement (IRC section R408.3)

## Venting Exceptions:

- Continuous exhaust (radon)
- Direct condition crawlspace (supply)
- Direct condition (dehumidifier)



## 402.4.2 WOOD BURNING FIREPLACES

New wood-burning fireplaces shall have tight-fitting flue dampers or doors, and outdoor combustion air.



## 402.4.4 ROOMS CONTAINING FUEL-BURNING APPLIANCES

The appliances and combustion air opening shall be located outside the building thermal envelope or enclosed in a room, isolated from inside the thermal envelope. Direct vent appliances with both intake and exhaust pipes installed continuous to the outside are exempt.

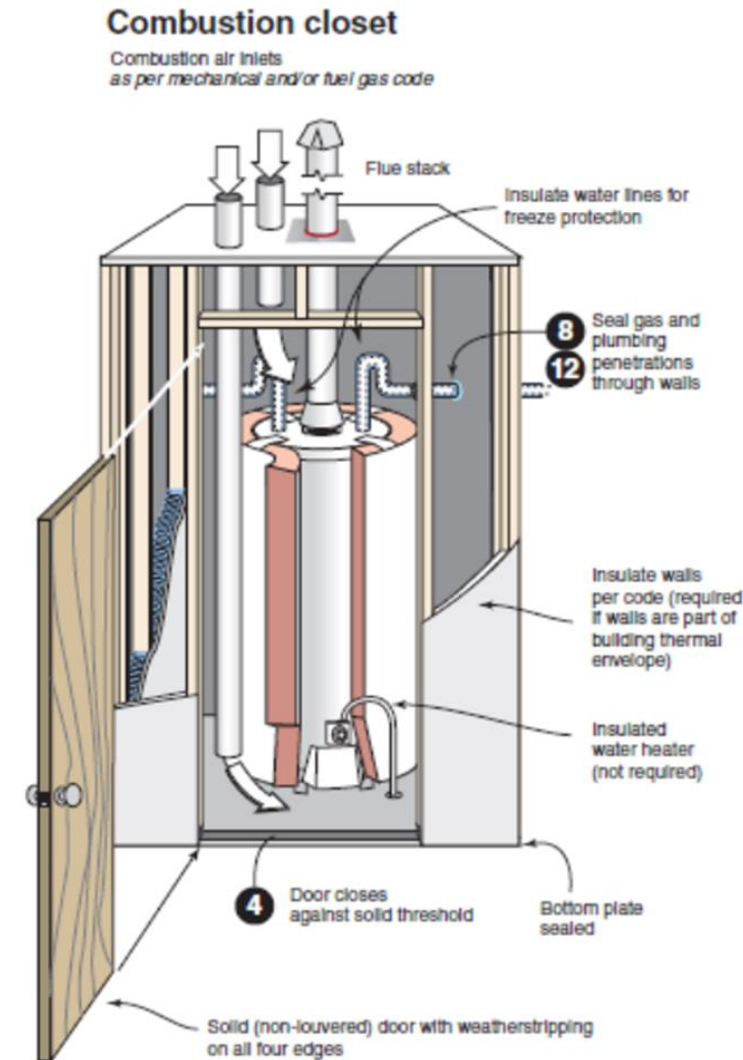

## DIRECT VENT APPLIANCES

Sealed combustion appliances do not need high/low vents because they get their air directly from the outdoors.

Direct vent water heaters are exempt for the same reason.

*Keep people air and combustion air separate.*



# HVAC REGISTER BOOTS

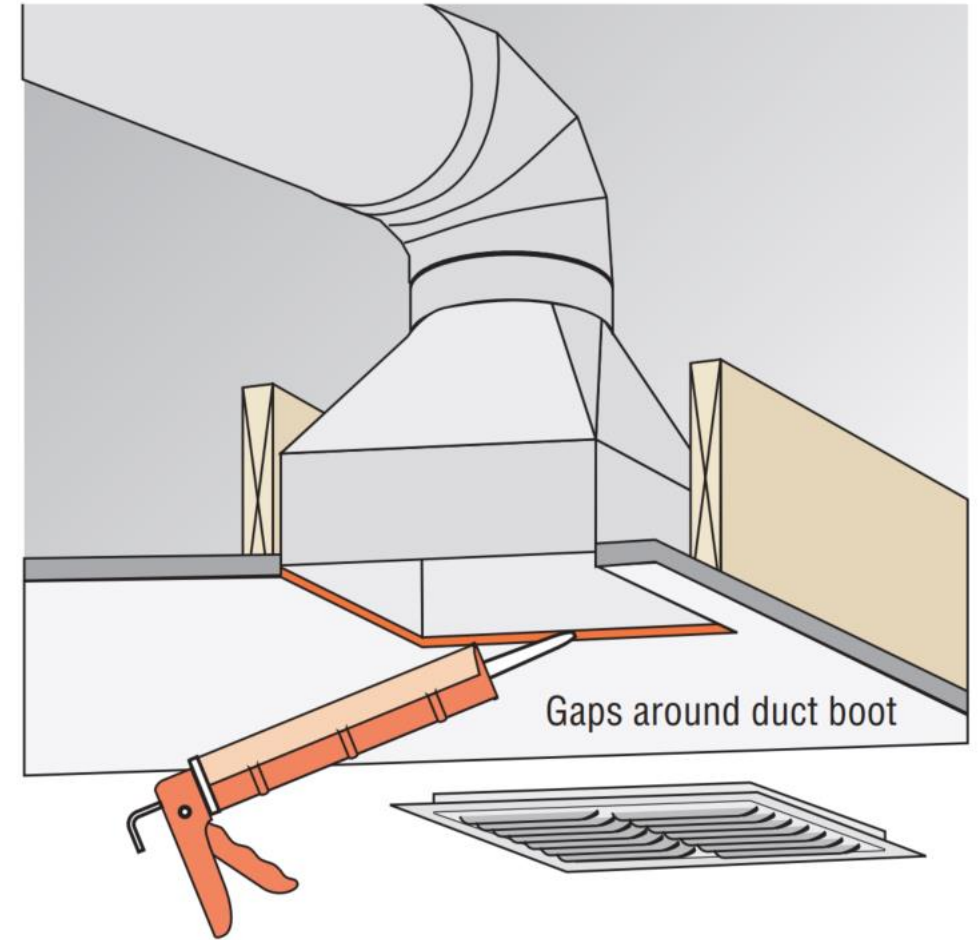
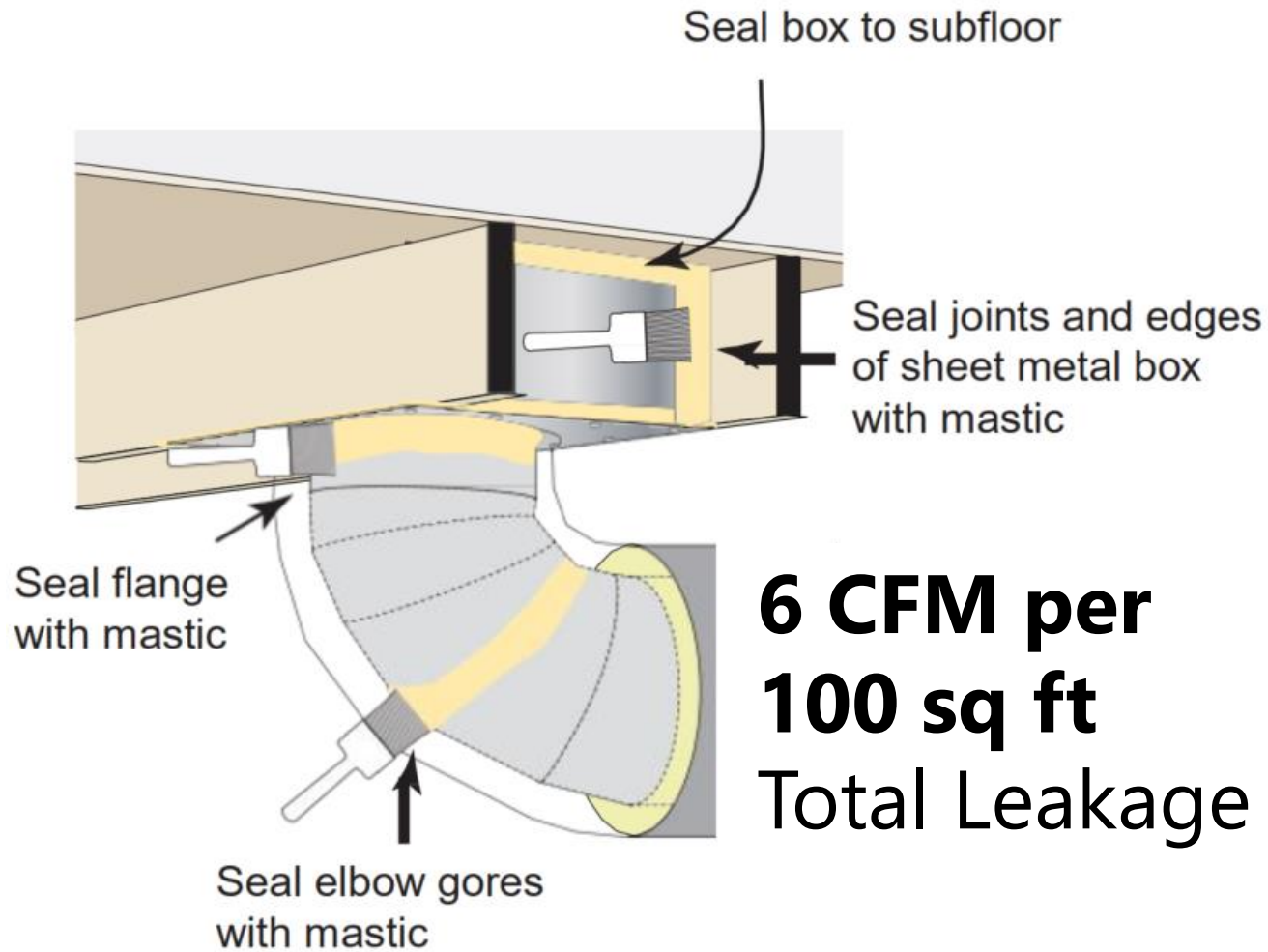

Duct boot penetration sealing



# WHOLE-HOUSE MECHANICAL VENTILATION

Ventilation Type	Pros	Cons
<p><b>Exhaust Only</b> Air is exhausted from the house with a fan</p>	<ul style="list-style-type: none"> <li>• Easy to install</li> <li>• Simple method for spot ventilation</li> <li>• Inexpensive</li> </ul>	<ul style="list-style-type: none"> <li>• Negative pressure may cause backdrafting</li> <li>• Makeup air is from random sources</li> <li>• Removes heated or cooled air</li> </ul>
<p><b>Supply Only</b> Air is supplied into the house with a fan</p>	<ul style="list-style-type: none"> <li>• Does not interfere with combustion appliances</li> <li>• Positive pressures inhibit pollutants from entering</li> <li>• Delivers to important locations</li> </ul>	<ul style="list-style-type: none"> <li>• Does not remove indoor air pollutants at their source</li> <li>• Brings in hot or cold air or moisture from the outside</li> <li>• Air circulation can feel drafty</li> <li>• Furnace fan runs more often unless fan has an ECM (variable-speed motor)</li> </ul>
<p><b>Balanced Air Exchange System</b> Heat and energy recovery ventilators supply and exhaust air</p>	<ul style="list-style-type: none"> <li>• No combustion impact</li> <li>• No induced infiltration/exfiltration</li> <li>• Can be regulated to optimize performance</li> <li>• Provides equal supply and exhaust air</li> <li>• Recovers up to 80% of the energy in air exchanged</li> </ul>	<ul style="list-style-type: none"> <li>• More complicated design considerations</li> <li>• Over ventilation unless the building is tight</li> <li>• Cost</li> </ul>

# WHOLE-HOUSE MECHANICAL VENTILATION

Whole-house mechanical ventilation is required at **3 ACH<sub>50</sub>**

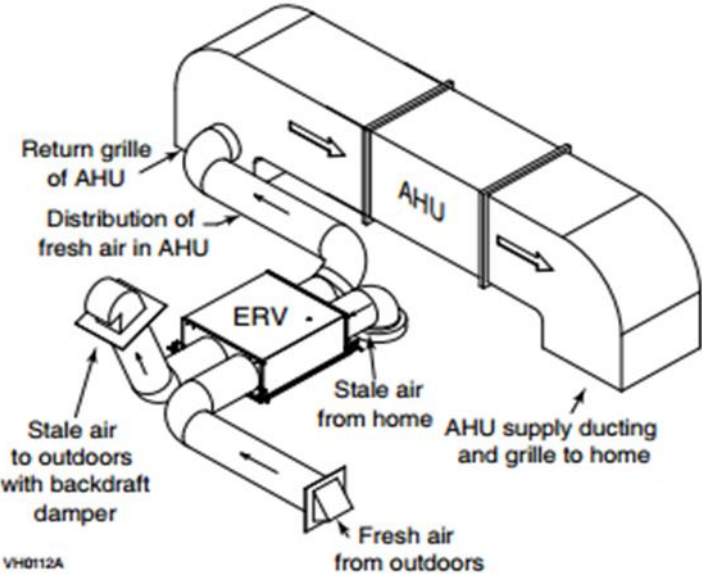

# THANK YOU!

---

Technical assistance or training requests can be submitted to  
**Georgia Energy Code Hotline** at: [energycodes@southface.org](mailto:energycodes@southface.org) or  
404-604-3598