



6 CHANNEL RADIO CONTROL SYSTEM

INSTRUCTION MANUAL



MODEL:FS-CT6A

Digital propotional radio control system

Menu

- 1. Introduction. 2
- 2. Services. 2
- 3. The special symbols. 3
- 4. safety guides. 3
- 5. Power charging. 4
- 6. Transmitter parameters. 5
- 7. Receiver parameters. 5
- 8. . Each part of the transmitter. 6
- 9. Receiver and server connectivity. 7
- 10. 2.4G Operation Notes. 8
 - 10.01 Matching. 8
 - 10.02 Boot. 8
 - 10.03 Shutdown. 9
- 11. Computer hardware connection steps. 10
- 12. Computer software installation. 11
- 13. Transmitter function notes (Heli) 12
 - 13.01 System function options. 12
 - 13.02 System function settings. 13
 - 13.03 Switches and potentiometer settings. 15
- 14. Transmitter function notes (Plane) 16
 - 14.01 System function options. 16
 - 14.02 System function settings. 17
 - 14.03 Switches and potentiometer settings. 18
- 15 Professional terminology. 19
- 16 Packaging with content list. 20

1.Introduction

Thank you for choosing 2.4 G ratio remote control digital products, if you are the first time to use this type of products, please read this statement carefully and strictly in accordance with the requirements of operation. You could refer to the Manual if you meet any problems during the operation . Please well keep the manual after use because you might have to use it again next time. Once again, thanks for buying our products, and hope that it brings happiness to you.

2.Services

If you found any problems during the operation process, please refer to the manual. If the problem still exist, you could contact our dealers to found out the way to solve. And you could also log on to our website service center:

HTTP : WWW. FLYSKYCHINA. COM

3.The special symbols

Please pay attention to the following symbols when it appears on the manual, and read carefully.

 **Danger:** If the operator does not operate by following the instructions, the operator may lead to serious injuries, even Mortal danger.

 **Warning:** If the operator does not operate by following the instructions, the operator may lead to serious injuries, even Mortal danger.

 **Attention:** If the operator does not operate by following the instructions, the operator may lead to minor injuries, but generally it will not cause serious injuries to the operator.



Prohibition



Mandatory

4.Safty guides



Do not fly in bad weather such as rainy or thundering to assure the safety of you and others.



Before you fly, please make sure the movement of server are correspond with the direction of joystick. If inconsistent, please adjust before fly.



You need to turn the throttle channel(ch3) and inching switch to the lowest before you use. Then switch on the transmitter power (red light or flashing means low battery), finally connect the receiver.



The Sequence to shut down is first turn the receiver power and the transmitter power.

If the above operations are reverse, it might lead to uncontrolled and cause accident.

5. Battery charging notes



If your transmitter, receiver using a nickel-cadmium, nickel-metal hydride rechargeable battery, you have to well-check before you fly. If lack of electricity, it could happen those phenomenon like inadequate control or out of control, resulting accident. So please charge immediately when low in battery.



If you are using a nickel-cadmium, nickel-metal hydride batteries for recharging, please use our company dedicated charger. If the electrical current is too large and it may lead to temperature over-heated and cause fire burning accident. Please cut off the power supply immediately after recharging. Please take out the battery from the transmitter when you are not using it within a period, it is because the battery may damage the aircraft batteries, thus being exposed.

Transmitter charger:

1. Install the battery to transmitter with correct direction, and cover it.
2. Connect the charger to the main connector.
3. Connect the charger to the transmitter Connector.
4. Cut off the power supply immediately after Recharge completed.

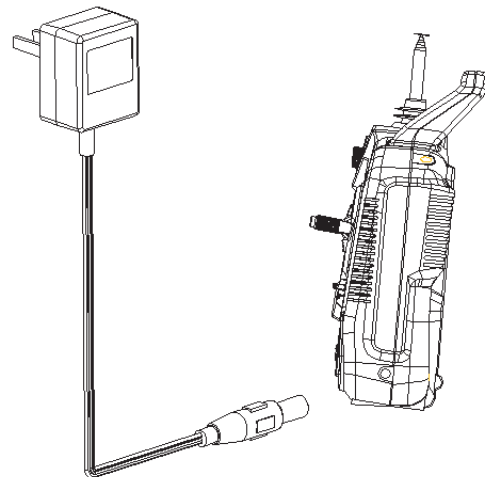

Receiver charger:

1. Connect the charger to the main connector.
2. Connect the Rechargeable receiver with battery charger
3. Recharge completed, cut off the power supply immediately.

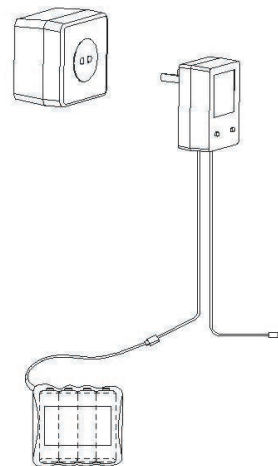

6. Transmitter parameters

- *Channels: 6
- *Charger port: Yes
- *Frequency band: 2.4GHz
- *Simulator port: PS-2
- *Power resource: 1.5V*8 "AA" Battery
- *Program type: GFSK
- *Modulation type: FM
- *RF power: 19db
- *Static current: $\leq 250\text{mA}$
- *Voltage display type: LED
- *Size: 189*97*218mm
- *Weight: 575g
- *Color: black
- *Antenna length: 26mm
- *Heli-140/Heli-120/Heli-90/Acro
- *Sub Trim: Yes
- *Thro Cuv: Programmable
- *Pith Cuv: Programmable
- *Support multiple user model
- *Support trim movement
- *Support rudder angle overturned
- *Support rudder angle adjustment
- *Support both hand software adjustment
- *Support swashplate adjustment
- *Support programmable channel output

7. Receiver parameters

- *Channel: 6
- *Frequency band: 2.4GHz
- *Power resource: 1.5V*4 "AA" Battery
- *Program type: GFSK
- *Modulation type: FM
- *RF Receiver sensitivity: -76db
- *Static current: $\leq 85\text{mA}$
- *Size: 45*23*13.5mm
- *Size: 25*16.8*6.5mm
- *Weight: 12g
- *Color: Gray semi-transparent
- *Antenna length: 26mm

8. Each part of the transmitter

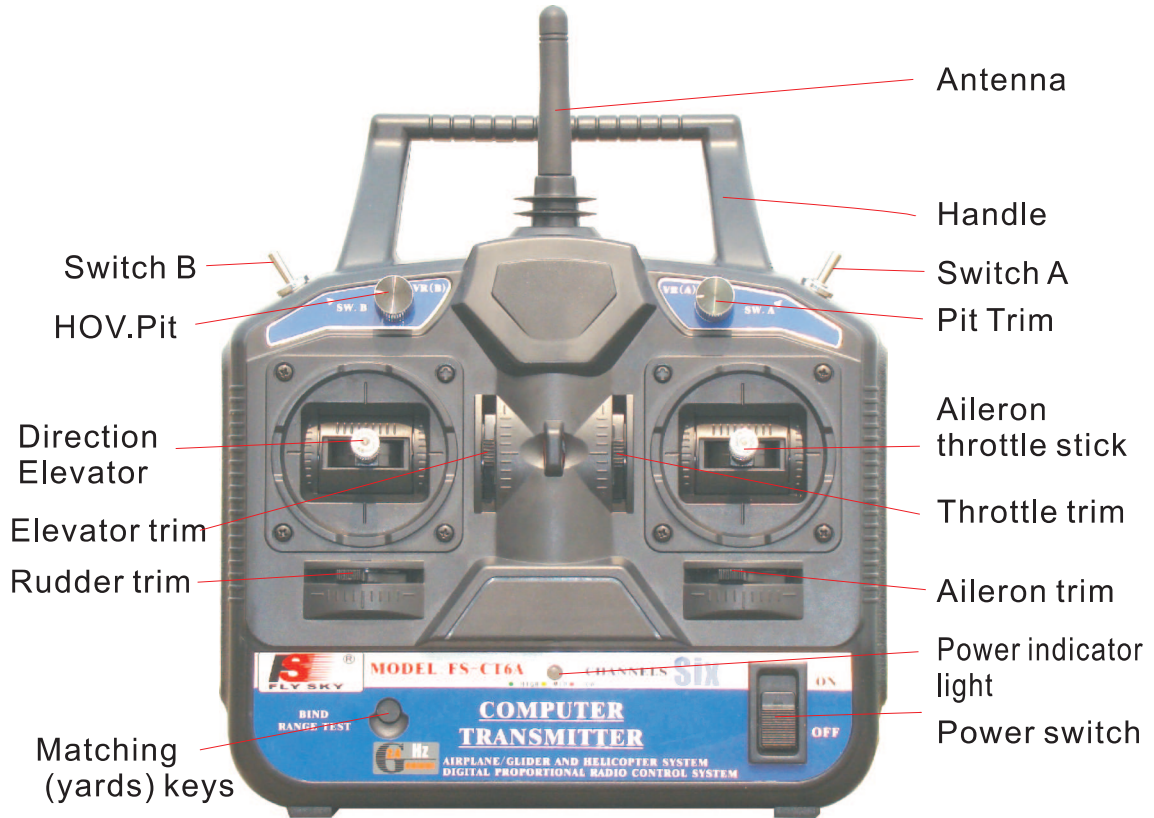

Front

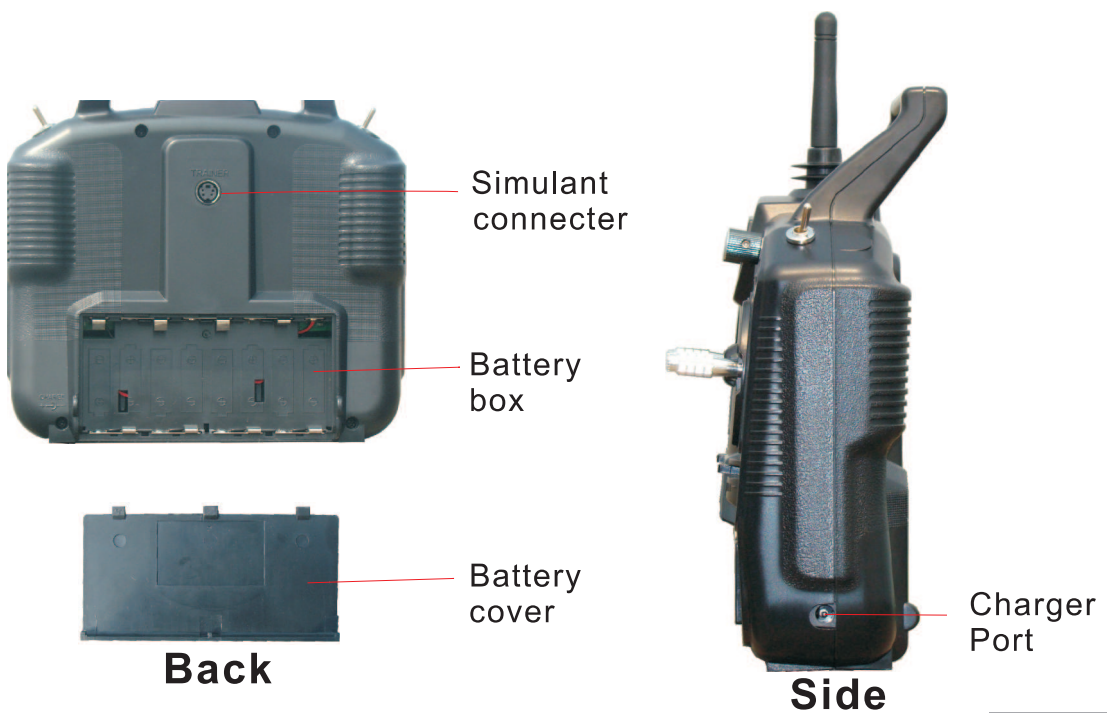

9.Receiver and server connectivity

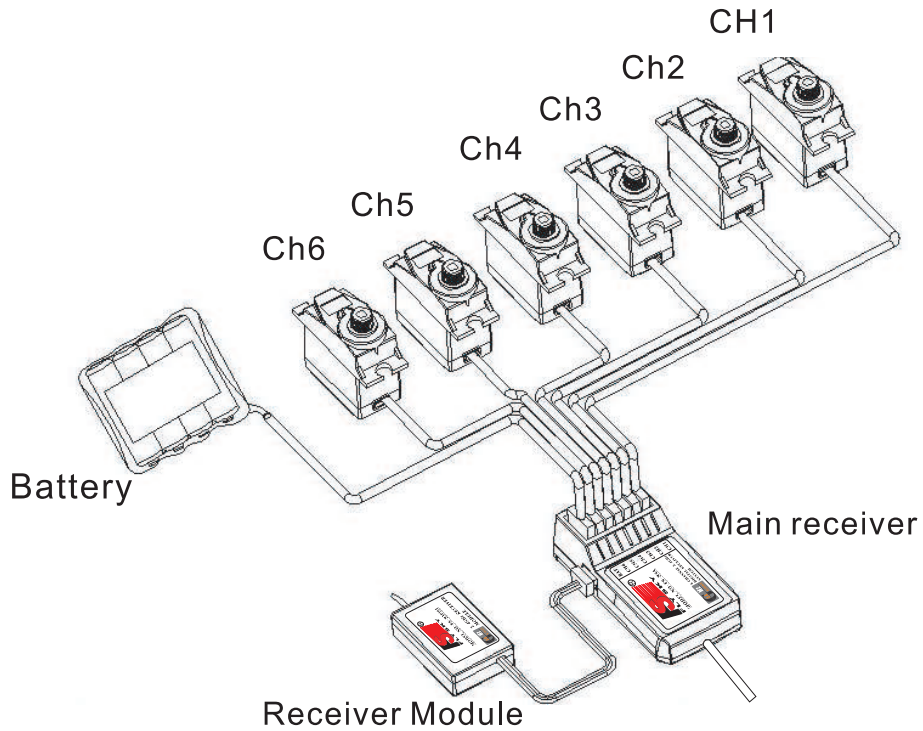

When installing the receiver please make sure that two items showed 90 degree angle.

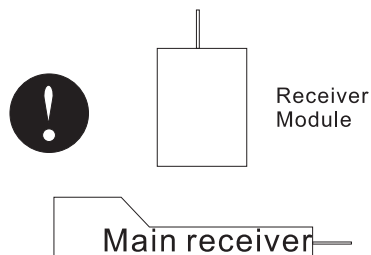

10. 2. 4G Operation notes

This is 2.4 G Frequency model products make of automatic address code. It use digital transmission mode, and this prevent outside interference effective active and passive.

10. 01 Matching (code)

Our products are well matched in the factory, you do not need to match by yourself. But if your are going to match the receiver with other transmitter, please follow the following steps:

1. Install the battery to 2.4G transmitter and shut it down.
2. Insert the matching lines to the channel Bat port of the receiver. (Figure.1) 。
3. Connect the receiver battery to any one of the channel port, on the same time the two LED are flashing and this means the receiver are going to the match status.
4. Press and hold the button on the transmitter, and then switch on the power supply.
5. Observe the LED on the receiver, if found that the LED is not flash anymore and that means successful matched. (This process about 10s)
6. Release the match button on the transmitter, take out the match line.
7. Install the server and then test.
8. If the tests fail, please repeat the action above.
9. If the tests success, then insert the power supply port into BAT, match complete. (The above ways of match is only suitable on FLYSKY 2.4G products)

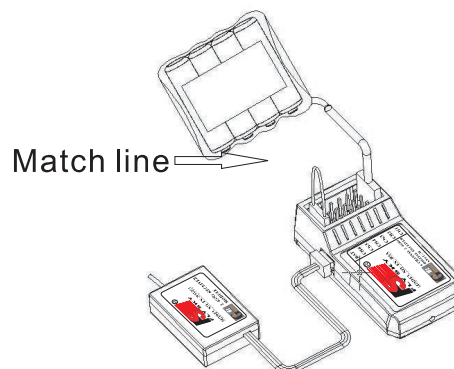
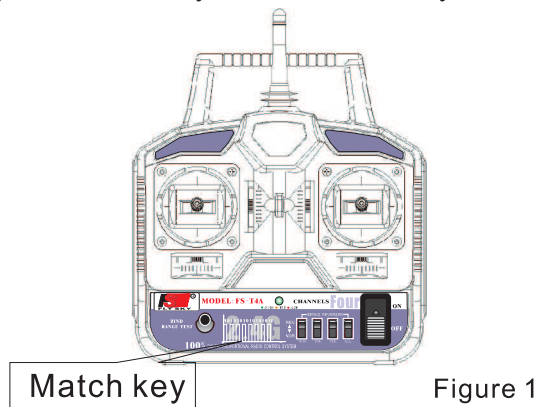

10. 02 Boot

1. Connect every part.
2. Switch on the power supply.
3. Connect the power supply.
4. Receive LED light solid.
5. Finish and use.

2.4G 6 Channel remote system

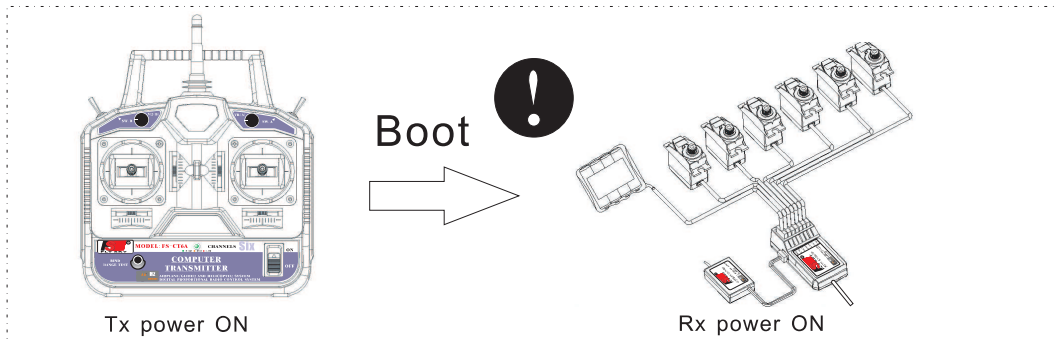

10.03 Shut down:

1. Cut off the receiver power supply.
2. Cut off the transmitter power supply.

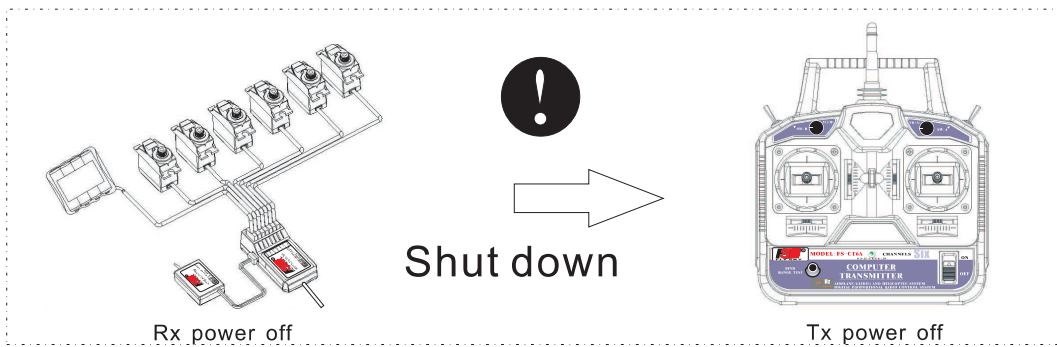

11. Computer hardware connection steps

When you buy the CT6 series remote systems, with a programming line you can set up the program by your own, this will bring you happiness. You have to follow the following steps when you process the program setup:

1. Install the battery to the transmitter and switch on the power.
2. Plug in the programming line to the transmitter port.
3. Plug in the other head of programming line to computer.
4. Launch the software program T6CONFIG.EXE.
5. Click on setting button, select programming lone port.
6. Click on GETUSER button, import the transmitter data to pc.
7. Apply programmable settings on the existing parameters.

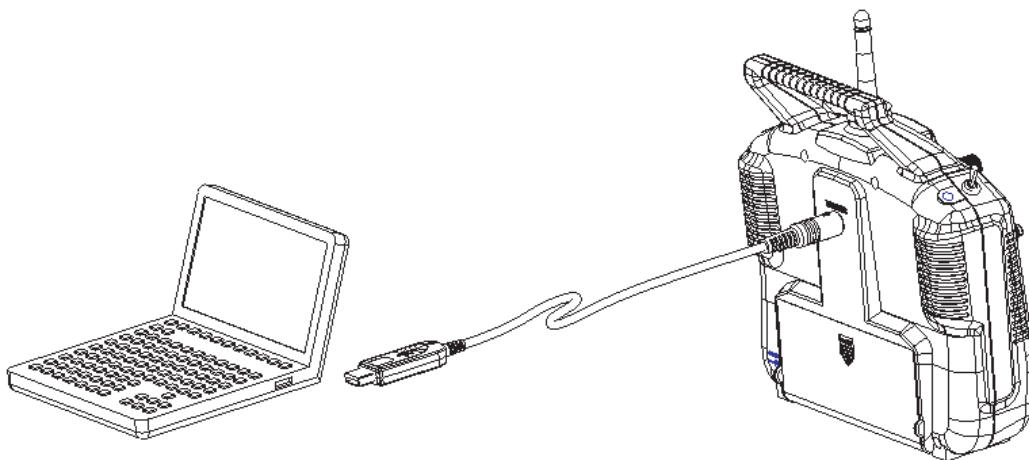

12. Computer software installation

FS-CT6A use the new computer programmable model design, every function of transmitter can be setup by computer. It makes you enjoy the fun of high-tech models.

12. 01 PC software download:

You can download from our website : WWW.FLYSKYCHINA.COM

12. 02 PC software installation:

1. Install driver software: FS-CT6DRIVER001. EXE
2. Install application software: FS-CT6SOFTWARE. EXE
3. Restare computer.
4. Installation completed.

12. 03 PC software application:

1. Install the battery to the transmitter and switch on the power.
2. Connect the transmitter, programming line and pc.
3. Left double-click the application icon and show up the following screen.

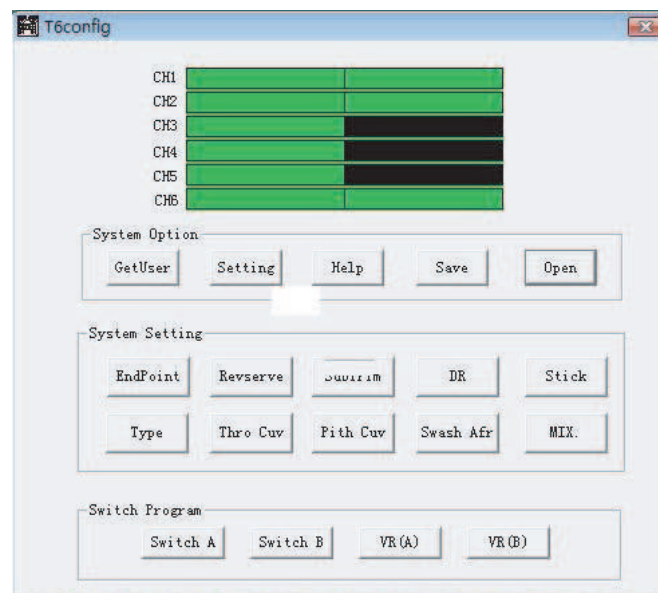

Application interface

13. Transmitter function notes (Heli)

Connect the transmitter programming line with pc, switch on the transmitter and application software. If you choose these types of heli (HELI90、HELI120、HELI140) the following interface will appear:

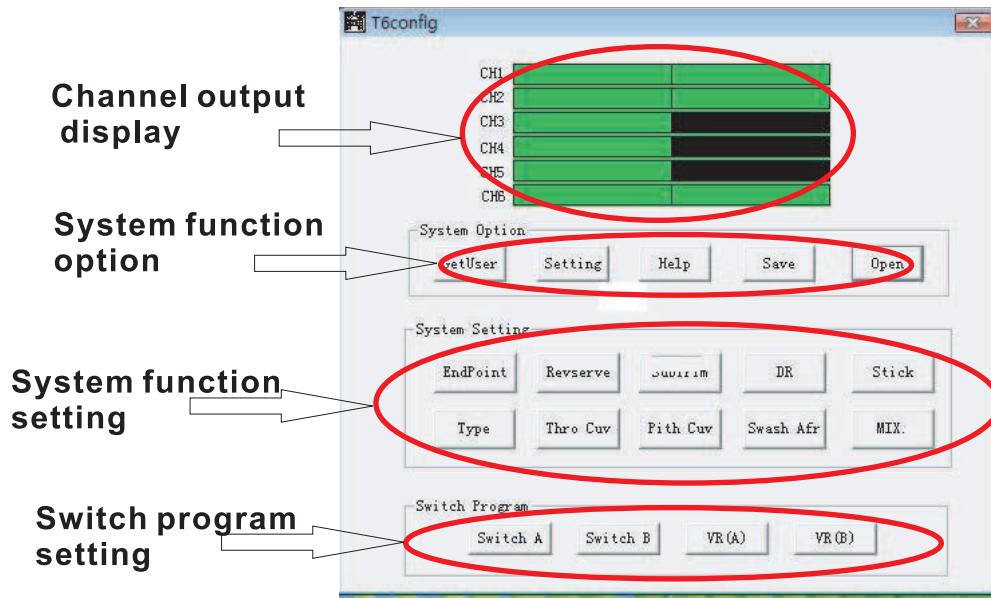

13. 01 System function option:

GETUSER: Import the transmitter data to pc.

When programming, please use GETUSER button to transfer the data to PC after make sure the setting function, this prevent the data overwrite.

Left click the 'SETTING' button, the screen on the right will appear, this system function is use for the programming line USB port selection, it improves the communication of Transmitter and PC. If select wrongly, the channel output display will not have any data changes and all other settings are invalid.

Press 'ok' button after finished selecting.

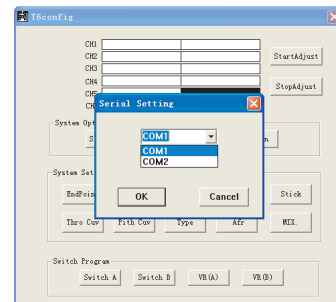

Left click the 'HELP' button on the interface, and the interface on the right will appear, this interface offer you some services information.

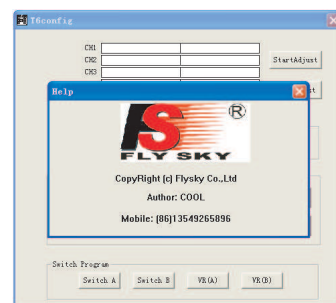

2. 4G 6 Channel remote system

Left click the 'SAVE' button on the interface, the screen on the right will appear, this function is for save all your settings. in theory, you can set up numerous types and save.

You can give it a name, and left click the 'save' button to save.

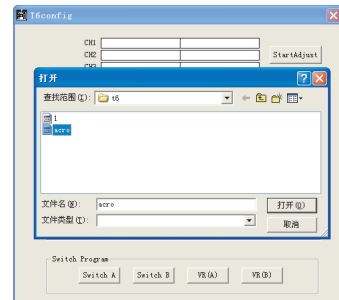

Left click the 'OPEN' button on the main interface, the screen on the right will appear, this system function is for the parameters setting.

Left click the 'save' button after select finished.

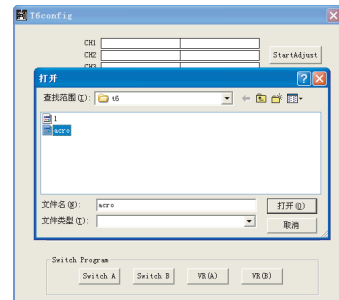

13. 02 System function settings

Left click the 'ENDPOINT' button on the interface, the screen on the right will appear, this function is use for adjust the movement of server to a suitable angel for a better control.

Each server are allowed to adjust Individual, it has two parts: left half part and right half part. Adjusted value from 0% to 100%, the number can be directly enter from the keyboard.

Left click the 'ok' button to finish the adjustment.
Left click the 'cancel' button to restore.

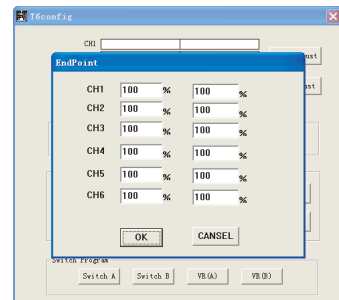

Left click the 'REVERSE' button on the interface, the screen on the right will appear, this function is use for change the direction of server movement, it keeps the transmitter control direction correspond to the server.

Left click the channel you want to change.
Click 'ok' button to finish the adjustment.

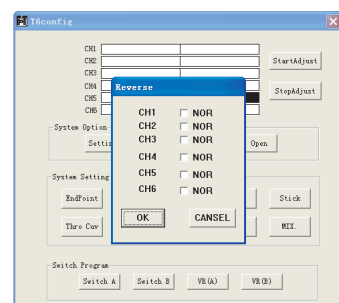

Left click the 'SUBTRIM' button on the interface, the screen on the right will appear, this function is use for adjustment for single server for a better control, improve the yarage of model.

Each server are allowed to adjust Individual, Adjusted value from -120 to 120. Number can be directly entered from the keyboard.

Click 'ok' button to finish the adjustment.

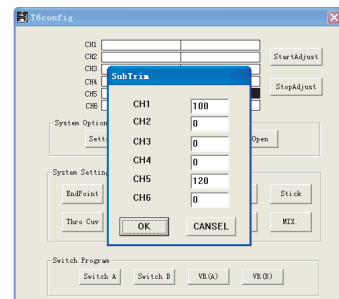

2. 4G 6 Channel remote system

Left click the 'DR' button on the interface, the screen on the right will appear, this function is use for Double ratio control of CH1\CH2\CH4 channel. It gives you the best control of the model. This function offer the great help to beginner.

CH1\CH2\CH4 are allowed to adjust Individual, Adjusted value from 0% to 100%. Number can be directly entered from the keyboard. This function will only take effect when the 'DR' button is switch on.

Click 'ok' button to finish the adjustment.

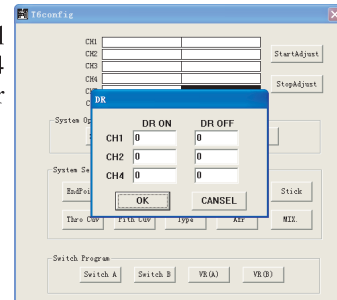

Left click the 'STICK SETTING' button on the interface, the screen on the right will appear, this function is use for control mode adjustment according to different customer's habit, this system offer four different mode to choose.

Click 'ok' button to finish the adjustment.

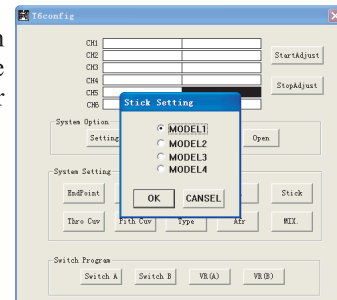

Left click the 'THRO CUV' button on the interface, the screen on the right will appear, this function is use for the adjustment of engine throttle curve to make it more suitable to the model and Play a better performance, and also improve the yarge of model.

It make up of two parts: normal state(NOR) and Stunt state(IDEL). Each state of the curve are make up by five point, each point can be setup Individually, Adjusted value from 0% to 100%, Number can be directly entered from the keyboard.

Click 'ok' button to finish the adjustment.

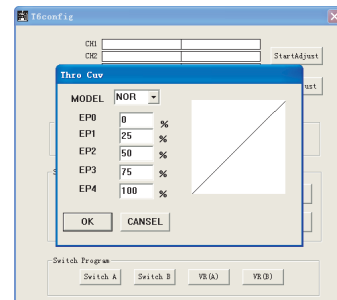

Left click the 'PITH CUV' button on the interface, the screen on the right will appear, this function is use for the adjustment of the helicopter PIT, it improves model control and also the yarge of model.

It make up of two parts: normal state(NOR) and Stunt state(IDEL). Each state of the curve are make up by five point, each point can be setup Individually, Adjusted value from 0% to 100%, Number can be directly entered from the keyboard.

Click 'ok' button to finish the adjustment.

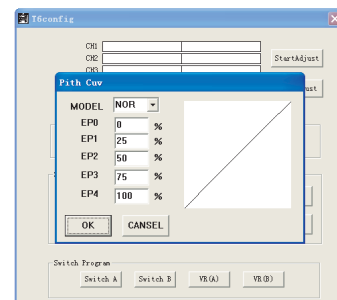

Left click the 'TYPE' button on the interface, the screen on the right will appear, this function is use for the model selection. This system offers four model to select: ACRO, HELI-90, HELI-120, HELI-140.

Click 'ok' button to finish the adjustment.

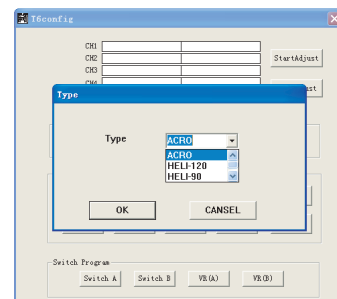

2. 4G 6 Channel remote system

Left click the 'ARF' button on the interface, the screen on the right will appear, this function is use for the swash plate adjustment of CCPM function helicopter, to have a better control. CH1\CH2\CH4 are allowed to adjust Individual, Adjusted value from 0% to 100%. Number can be directly entered from the keyboard.

Click 'ok' button to finish the adjustment.

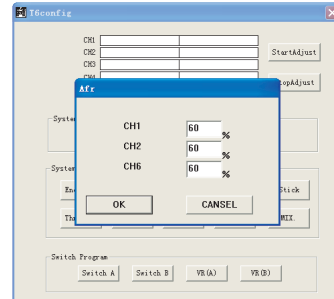

function is use for the programmable mixed control function, it offers some special function.

This system offers three individual mixed control function(MIX1/MIX2/MIX3)

Source: mixed control source select.

Des: destination select

Up rate: upper part's mixed control ratio (-100%to100%)

Down rate: lower part's mixed control ratio (-100%to100%)

Switch: Activation ways (OFF.ON.SWA.SWB)

Click 'ok' button to finish the adjustment.

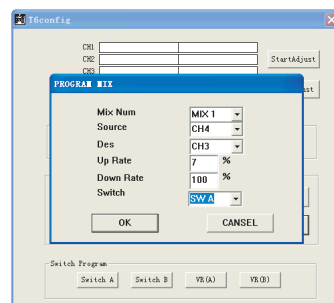

13. 03 Switch and Potentiometers settings

Left click the 'SWITCH A' or 'SWITCH B' button on the interface, the screen on the right will appear, this function is use for correspond function select setting of switch A and switch B. following are the choice of content:

NULL.DR.NORID.THRO.CUT.

Click 'ok' button to finish the adjustment.

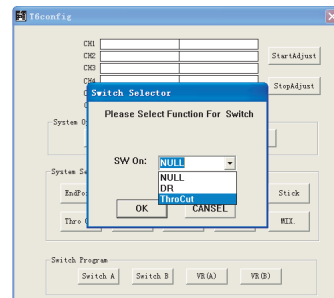

Left click the 'VR (A)' or 'VR (B)' button on the interface, the screen on the right will appear, this function is use for correspond function select setting of both Potentiometers, following are the content setting:

NULL.PITH ADJUST.

Click 'ok' button to finish the adjustment.

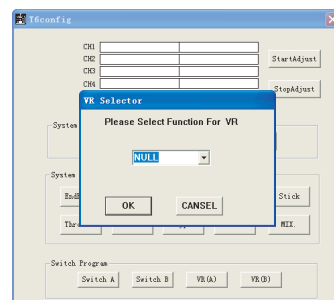

14. Transmitter function notes (Plane)

Connect the transmitter programming line with PC, switch on the transmitter and PC software. When you select Fixed-wing aircraft (ACRO), the following interface will appear:

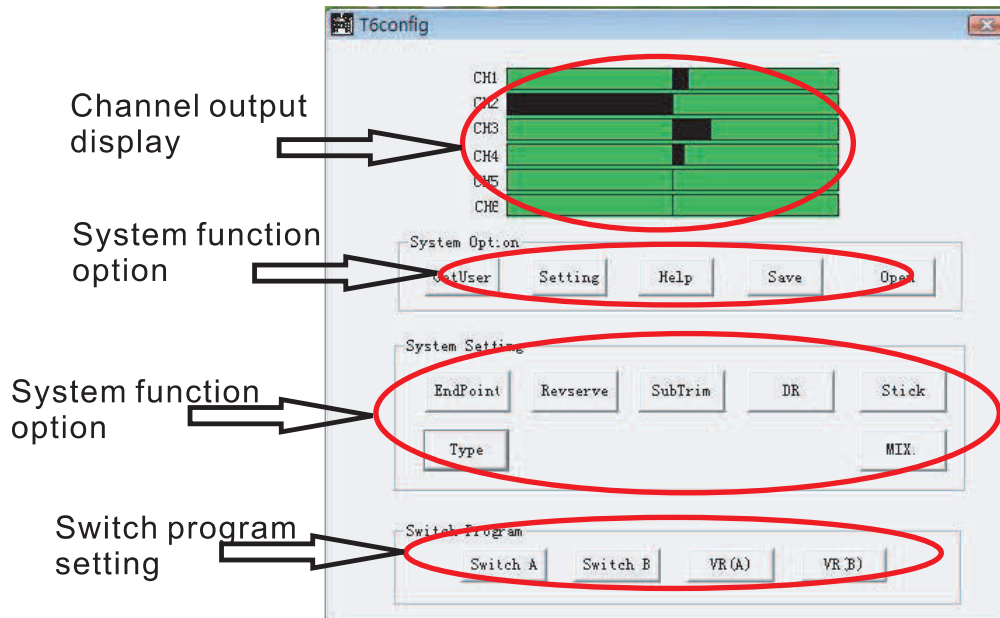

14. 01 System function option

GETUSER: Import the transmitter data to pc.

When programming, please use GETUSER button to transfer the data to PC after make sure the setting function, this prevent the data overwrite.

Left click the setting button, the screen on the right will appear, this system function is use for the programming line USB port selection, it improves the communication of Transmitter and PC. If select wrongly, the channel output display will not have any data changes and all other settings are invalid.

Press 'ok' button after finished selecting.

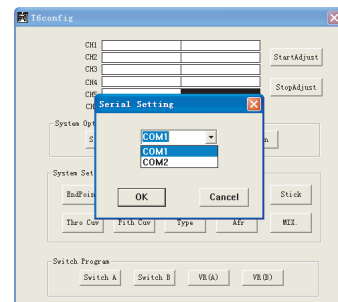

Left click the 'help' button on the interface, and the interface on the right will appear, this interface offer you some services information.

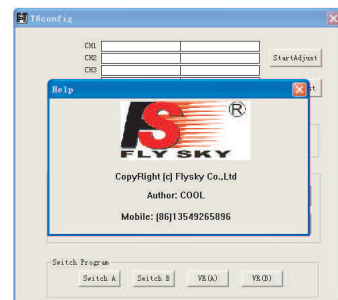

2. 4G 6 Channel remote system

Left click the 'SAVE' button on the interface, the screen on the right will appear, this function is for save all your settings. in theory, you can set up numerous types and save.

You can give it a name, and left click the 'save' button to save.

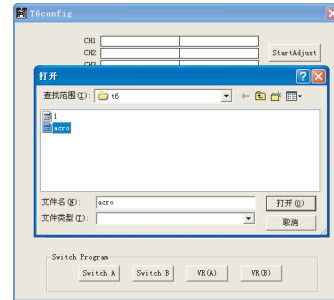

Left click the 'OPEN' button on the main interface, the screen on the right will appear, this system function is for the parameters setting.

Left click the 'save' button after select finished.



13. 02 System function settings

Left click the 'ENDPOINT' button on the interface, the screen on the right will appear, this function is use for adjust the movement of server to a suitable angel for a better control.

Each server are allowed to adjust Individual, it has two parts: left half part and right half part. Adjusted value from 0% to 100%, the number can be directly enter from the keyboard.

Left click the 'ok' button to finish the adjustment.
Left click the 'cancel' button to restore.

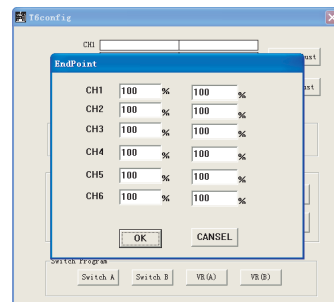

Left click the 'REVERSE' button on the interface, the screen on the right will appear, this function is use for change the direction of server movement, it keeps the transmitter control direction correspond to the server.

Left click the channel you want to change.
Click 'ok' button to finish the adjustment.

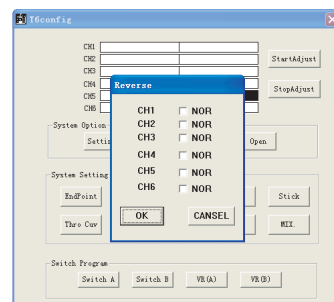

Left click the 'SUBTRIM' button on the interface, the screen on the right will appear, this function is use for adjustment for single server for a better control, improve the yarge of model.

Each server are allowed to adjust Individual, Adjusted value from -120 to 120. Number can be directly entered from the keyboard.

Click 'ok' button to finish the adjustment.

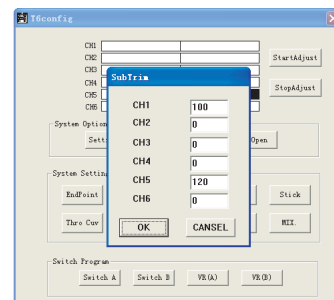

2. 4G 6 Channel remote system

Left click the 'DR' button on the interface, the screen on the right will appear, this function is use for Double ratio control of CH1\CH2\CH4 channel. It gives you the best control of the model. This function offer the great help to beginner.

CH1\CH2\CH4 are allowed to adjust Individual, Adjusted value from 0% to 100%. Number can be directly entered from the keyboard.

This function will only take effect when the 'DR' button is switch on.

Click 'ok' button to finish the adjustment.

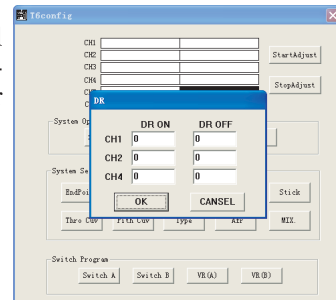

Left click the 'STICK SETTING' button on the interface, the screen on the right will appear, this function is use for control mode adjustment according to different customer's habit, this system offer four different mode to choose.

Click 'ok' button to finish the adjustment.

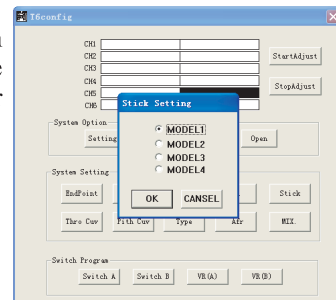

Left click the 'THRO CUV' button on the interface, the screen on the right will appear, this function is use for the adjustment of engine throttle curve to make it more suitable to the model and Play a better performance, and also improve the yarage of model.

It make up of two parts: normal state(NOR) and Stunt state(IDEL). Each state of the curve are make up by five point, each point can be setup Individually, Adjusted value from 0% to 100%, Number can be directly entered from the keyboard.

Click 'ok' button to finish the adjustment.

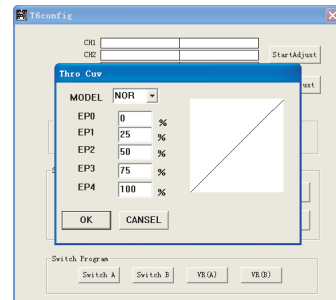

Left click the 'PITH CUV' button on the interface, the screen on the right will appear, this function is use for the adjustment of the helicopter PIT, it improves model control and also the yarage of model.

It make up of two parts: normal state(NOR) and Stunt state(IDEL). Each state of the curve are make up by five point, each point can be setup Individually, Adjusted value from 0% to 100%, Number can be directly entered from the keyboard.

Click 'ok' button to finish the adjustment.

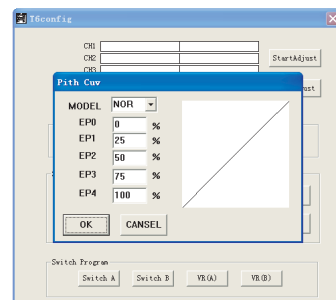

Left click the 'TYPE' button on the interface, the screen on the right will appear, this function is use for the model selection. This system offers four model to select: ACRO, HELI-90, HELI-120, HELI-140.

Click 'ok' button to finish the adjustment.

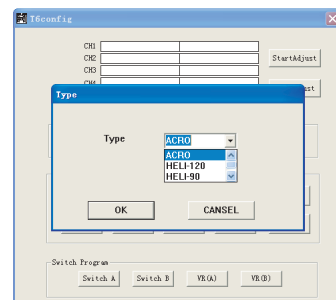

15. Professional terminology

AIL:副翼
ELE:升降舵
THR:油门
RUD:方向舵
GEAR:
PITCH:螺距
FM:调频
PPM:脉冲相位编码
PCM:脉冲数据编码
MODULE:调制
RF:射频
DR:双重比率
TRAINER:教练
STICK:操纵杆
NULL:无功能
REV:反向
NOR:一般
TRIM:微调
SUB. TRIM:辅助微调
HELI:直升机
ACRO:飞机
VR:电位器
SW:开关
UP:上
DOWN:下
DES:目标
SOURCE:起源
IDEL:特技

16. Packaging with content list

NO :	Model	Sum	Remarks
1	6 channel 2. 4G transmitter (FS-CT6A)	1	
2	6 channel 2. 4G receiver (FS-CT6A)	1	
3	Match(code)line	1	
4	Programming line	1	Optional
5	PC software、CD	1	Optional
6	Charger	1	Optional
7	Server (FS-S036)	4	Optional
8	Transmitter (FS-CT6A)	1	

