

General Surgical Instruments Catalogue



Surgical Holdings
Instruments



Symmetry
Surgical



Hermann
Laparoscopic



Bissinger
Bipolar



Light
Leads



DIN Baskets
& Containers



Sterile Packed
K-Wires



Promoting education;
sharing knowledge and
offering training opportunities



Custom-made
Instruments

Working in close partnership with our customers, we manufacture innovative and bespoke instrumentation.

We have over 50 years of knowledge and experience in our workshop. Our team of highly skilled technicians undertake a minimum apprenticeship of 5 years and are trained to manufacture instruments, rather than just repair them. This gives us 360 degree understanding of the challenge and the importance of correctly functioning medical devices.



We care immensely about the work we do, never forgetting that instruments we create and repair are responsible for saving lives.

We insist on controlling the quality of every item we manufacture, from the materials used to the rigorous procedures we apply to testing. Our range of supporting products are serviced and repaired in-house, ensuring we are always able to exceed our customers' expectations.

Customers can receive training, participate in factory visits or simply call their local representative for guidance with instrumentation or management.

Skill-sharing has been at the heart of our business for four generations and we frequently arrange workshops and attend events at which we can educate others.

Quality Assurance

We are an ISO 13485 accredited company.

Our comprehensive quality management system is in accordance with the requirements of the Medical Device Directive 93/42/EEC - Annex I & II, for temporary orthopaedic surgical implants - skeletal pins, wires, staples, guide wires - and all associated instrumentation.

All Surgical Holdings products undergo rigorous testing and inspection to applicable harmonised standards before leaving the factory. We offer CE marking on all Class I instrumentation, Class IIa and IIb implants, and can provide certificates of conformity for all materials used. Complete traceability throughout all aspects of the production process provides our customers with a fully documented quality control system.

All instrumentation carries a lifetime guarantee from the date of purchase on any fault found as a result of poor materials. This warranty is void, however, if repairs are carried out by anyone other than Surgical Holdings repair personnel, or if it is deemed to have been misused.

Please contact us or visit our website for current reprocessing instruction.



Visit us for a Workshop Tour



Want to see our strong family ethos in action? Our 24 hour promise means you can drop in on us at short notice for a guided tour. No grand clean up or special planning will be needed - we're confident for you to see us as we really are.

Pop in any day and you'll see:

- Instrument manufacturing
- Laparoscopic instrument repair
- Ortho implants manufacturing
- Power tool repair
- Instrument repair
- Scope repair

We've invested in new machinery to help improve quality and reduce turnaround times. We'll show you our recent upgrades including:

- £100k worth of ultrasonic cleaners, taking the cleaning and passivating process from 30 minutes to just 3 minutes!
- Laser welders
- Marker machines



We're in an excellent location for export customers, just 40 miles from London, at the mouth of the Thames Estuary.

 **By road:** A13 or A127 to M25
Dartford Tunnel and south coast ports

 **By rail:** Direct links to London
Liverpool Street, London
Fenchurch Street & St Pancras
International via Stratford

 **By air:** International flights from
Heathrow or Gatwick 90 minutes
away, Stansted 60 minutes,
and Southend airport is just 10
minutes away with direct flights
to major cities across Europe

**Surgical Holdings, Parkside Centre,
Temple Farm Industrial Estate,
Southend-on-Sea, Essex, SS2 5SJ**

Contents

Introduction	2
About Surgical Holdings	4
Our Services	6
CPD Training Procedures	10
CPD Accredited Webinars	11
Case Study	12
General Instruments	13
Artery Forceps	14
Clamps	17
Spring Forceps	19
Tissue Forceps	20
Sponge Holding and Sterilising Forceps	22
Other Forceps	23
Scissors	24
Needle Holders	29
Combined Scissor and Needle Holders	33
Bag and Towel Clips	34
Retractors	35
Dissectors and Probes	43
Miscellaneous	44
Hollow Ware	45
Silicone Matting	46
Sterilising Baskets	46
Optical Fibre Cables	48
Index	50
Our Manufacturing Partners	54

How To Order

- 1 Choose your desired product from our extensive range or send your detailed tray list to us and we'll do the work.
- 2 Email info@surgicalholdings.co.uk or call +44 (0)1702 602050 with the product codes and we will provide you with a quote.
- 3 Upon approval of the quote we will process your order.



NEED A BESPOKE INSTRUMENT?

CONTACT OUR FRIENDLY TEAM
TO DISCUSS YOUR REQUIREMENTS

How To Pay

30 days credit is available (subject to status checks) or we accept Visa, Mastercard, Amex cards and cheque payments.

30 DAYS CREDIT



About Us



Surgical Holdings is a family run business, established for 30 years and counting.

Based in Southend-on-Sea, we are an award-winning British surgical instrument manufacturer and repairer, facilitating sustainability in surgery; through our range of reusable instruments and laparoscopic instruments, of which can be serviced in-house by our experienced and specialist technicians.

Our SMART REPAIR service for rigid endoscopes and our 'as new' full surgical tray refurbishments, save 50% in CO₂ vs buying new. We also distribute key industry brands, including the Bookwalter retractor.



Our Company History

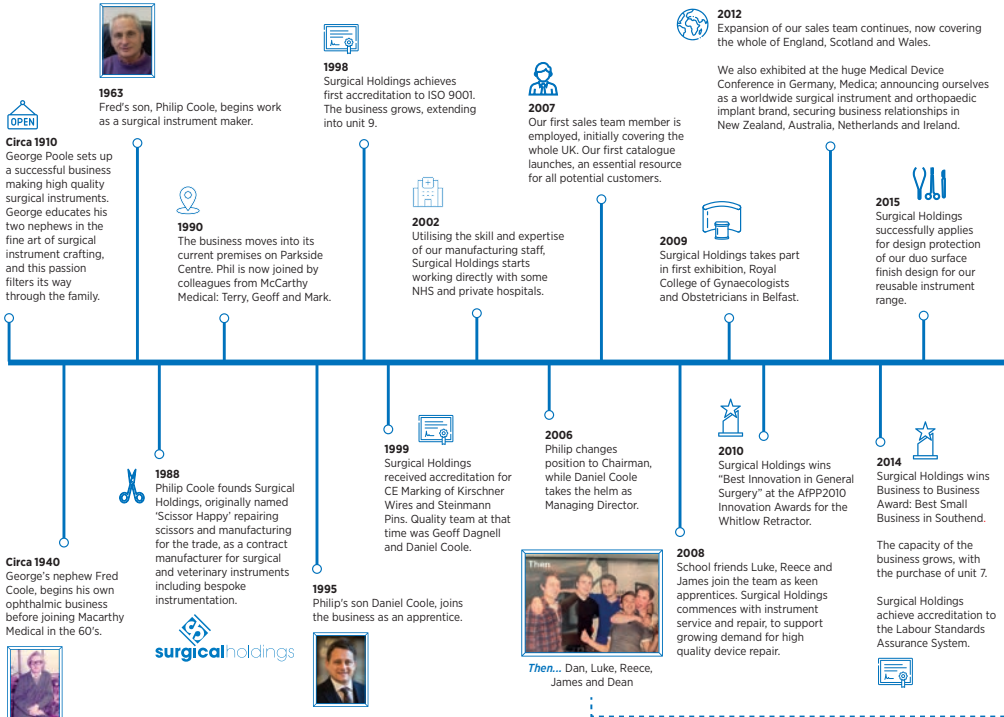





Mission, Vision and Values

Our **Mission** is to sustainably manufacture, service and distribute medical devices for the UK healthcare sectors and export partners worldwide. Expertly working to our specialisms, whilst promoting education and continual development of our employees, we maintain our dedication to our safety, unique skill, products and services.

Surgical Holdings' **Vision** is to be recognised by our stakeholders as the most passionate, authentic and knowledgeable surgical instrument manufacturer and service provider in the UK.

Values:

		
EDUCATION	TRANSPARENCY	FAMILY
		
PASSION	RESOURCEFULNESS	



2017
Rigid Endoscope Repair Workshop opens, appointed with innovative technical equipment to facilitate the highest quality repairs. Our export base continues to grow, with appointment of a key partner in Malaysia.

We start working with one of our key brands Symmetry Surgical, bringing products like the Bookwalter Retractor and the Thomas Codman instruments to our customers.



SURGIFIX

2019
Surfix is made available to customers for the first time, as our repair service is merged and identified as SMART REPAIR, giving customers unique dashboard access.

Version 4 of our catalogue is published.

We exhibit at Medica, this time promoting our rigid endoscope repair service for our export marketplace.



2021
Orthopaedic Power Tool Repair Workshop opens, offering repair of Large Bone Battery Hand Pieces.

Surgical Holdings Accredits their first CPD approved workshop for continuing professional development in Surgical Instruments and medical devices.

Employment of our first marketing executive, to support customers and our sales team.



Promoting education, sharing knowledge and offering training opportunities

2022
We establish our modern day driven themes and company values, putting education at the forefront to trainees, apprentices, graduates, and industry enthusiasts.

We also expand our premises into neighbouring unit 10 following Southend gaining a city status.

Investment in new state-of-the-art cleaning line, and laser marking machines.

Appointment of additional sales team member in South East & London and Scotland.



Established a partnership with TrustLinks, South East Essex's local independent charity for mental health and wellbeing.

Successful recertification audit for ISO 13485 and CE Marking for orthopaedic implants.

Think TWICE

We have successfully launched our CPD Training Procedures including our Think Twice Educational Programme, enabling our qualified Representatives to host Rigid Endoscope Fault Identification training courses and conduct Scope Audits.

2016
We begin working with operating rooms in Northern Ireland, extending our sales coverage across the whole of the UK.



2018
Our focus on quality continues, as we appoint a new quality manager to drive the business forward.

SMART REPAIR

2020
With success from our Surgifix platform, SMART REPAIR is put to the forefront, tying in with our company focus of sustainability and ethical duty. This unique repair service promises to replace an instrument with a new one if we can't repair an instrument to 'as new' condition.

We complete the 5000th in-house rigid scope repair.



2021
At the present day, our once apprentices are now established as Operations Manager, Assistant Factory Manager, and our most specialist Repair Technicians.



And now... Dan, Luke, Reece, James and Dean



Looking ahead
We continue to invest and train our instrument makers of the future.

Our team continues to grow, with us now employing 50 people in our Southend city base, enabling us to support our customers' needs. Please add and further invest in the company's Social Value.

Customers are valuing British made instrumentation, as we strive to support NHS and private hospitals to recover from waiting lists as a result of Covid.

All our company vehicles for representatives are either fully electric or hybrid.

Proud to be a family-run British company

Our Services

Instruments are repaired to BS 5194 where possible, OEM specification in accordance with the recommendations laid out in MHRA 'Managing Medical Devices,' ensuring CE marking remains valid.

REPAIRED

High quality materials are used, providing full traceability as every part is recorded. Replacing instruments is avoided wherever possible.

TESTED

Independent testing helps benchmark repairs against industry standards.

UPCYCLED

If an instrument is not to our high standards or we can't repair it, we will replace it with a brand new one for the cost of a repair*. This ensures continual upcycling of your trays.

MARKED

Instruments can be laser marked, encoded and GS1 2D matrix marked at the same time as a repair.

*Applies to selected instruments only, please get in touch for full details.

ACCREDITED

Repairs are ISO 13485 accredited.

GUARANTEED

Customers receive an industry leading 18 month warranty as standard on all instrument repairs.

INSURED

We carry full product, professional liability and transit insurance.

DELIVERED

Standard turnaround times are 1 week, an express 2 day service is available.

Our instrument technicians carry out a minimum apprenticeship of 5 years and are trained to manufacture instruments rather than simply repair them. This gives us 360 degree understanding of the challenge and the importance of correctly functioning medical devices.

The Repair Process



Our expertise means that instruments can be modified or remanufactured if required. Customers can also receive training, participate in factory visits or simply call their local representative for guidance with instrumentation or management.

Our Services

Instrument and Power Tool Repair

We repair general instruments, laparoscopic and electro-surgery instruments

- Instruments are repaired by an experienced instrument 'maker', not just trained on repairs
- All market brands of leading power, battery and pneumatic tools repaired
- Brand new parts with full traceability
- Full tracking of devices from handover to return through Surgifix
- Option for free personal pick up and delivery through our team



SMART REPAIR

SURGIFIX
ONLINE PORTAL



SMART REPAIR is our unique repair service for surgical instruments, offering the promise of long-term value for money in choosing the sustainable option, and a product replacement if we are unable to return the instrument to an 'as new' condition*.

In choosing our innovative Smart Repair service, customers benefit from dashboard access to our Surgifix Online Portal.





*For the price of the repair. Applies to the 50 most used and repaired products, correct at the time of going to press.

Surgifix Repair Portal

Designed to make managing repairs easy and quick

Manage and monitor repairs online, and communicate directly with the repairs team.

On the Surgifix Repair Portal customers can:

-  View pricing, create quotes, and view the progress of repairs. These can be printed or saved.
-  Historical endoscope repair reports are available.
-  Instant notifications allow the repairs team and customers to communicate seamlessly regarding what needs a repair or refurbishment.
-  Training is available and can be done on a video call if required.

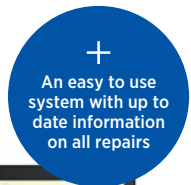

Our Services

Endoscope Repair

All major brands of rigid endoscope can be repaired at Surgical Holdings workshop in Southend-on-Sea. Using the latest optical technology, Surgical Holdings' highly skilled and experienced technicians will return scopes to the manufacturer's original specification. All parts are brand new and have full traceability.





 18 month guarantee on the repair

 OEM optical specification followed where possible

 Personal collection and delivery

 Laser welding for sheaths

 ISO 13485 accredited
As recommended by MHRA* advice around endoscope storage and care

 Free educational visits to our scope workshop
See all our repair facilities

+
We also repair the
Olympus
ENDO-EYE

A hassle-free and easy endoscope repair service



Maintenance scheduled



Collected and checked



Repaired and refurbished



Return by courier or hand delivered within 7 days

+ Proactive Management of Endoscopes

Surgical Holdings can set up and manage a 'check and repair' service for rigid endoscopes. This ensures scopes are regularly checked, refurbished, repaired and maintained to a high standard. We will catalogue scopes and create a maintenance schedule.

*MHRA Managing Medical Devices - April 2016

Instrument Refurbishment

Refurbishing instruments can save up to

80%

of the cost of buying new, with compelling evidence to demonstrate effectiveness

Independent research¹ showed that instruments refurbished by Surgical Holdings had a 4x reduction in the amount of residual protein.

The smooth and polished surface has an increased cleaning efficacy, and all refurbishments come with an 18 month warranty as standard. Standard turnaround times are 1 week, and an express 2 day service available.

Reference: ¹Data available on file.



Our Services

Endoscope Audits

Is your scope suitable for use? Think **TWICE**

TIP

Check the tip of the endoscope for sharpness and any type of damage to the tube such as dents and cracks

WINDOWS

Make sure the windows at the tip and eyepiece are free from dirt and cracks

ILLUMINATION

Hold the scope lightpost to a light source to see if the output is bright and clear at the tip

CLARITY

Look through the eyepiece, is the image clear and free from shadows, dots and lines

ENVIRONMENT

If you think twice and the endoscope isn't suitable for use then think of the environment and repair instead of replace



We offer a comprehensive scope auditing service

Can we help with your auditing? Please contact your local Surgical Holdings representative to book.



At Surgical Holdings we have 500 years worth of combined medical device manufacture experience. We're passionate about what we do and are keen to pass that wealth of knowledge onto our customers. We believe it is important to educate and train others, to help them get the most out of their instruments and so they last for many, many years.

We offer Rigid Endoscopy Fault Identification Workshops where we visit you and:



Show you the difference between poor quality and high quality instruments to help you make the right choices when purchasing



Train you on cleaning and maintenance to help keep your instruments in good condition



Walk you through our repair and refurbishment processes, so when the time comes you'll know exactly how your instruments will be cared for



Contact your local rep to arrange a training workshop

CPD Accredited Webinars

We also offer CPD accredited webinars, to boost your ongoing learning and help with your revalidation.

This includes our new module on the **Quality Checking of Rigid Endoscopes**, without the need for expensive checking apparatus. We introduced this module following feedback from stakeholders in sterile services and theatres.

Our team have designed a training SOP that can be integrated into your internal QMS systems, covering the different faults we see and how they can be identified. Once the training module is completed, you will then be issued a certificate directly via CPD. We'll leave you competently trained and externally accredited, so you can then train other staff members.

We are looking forward to working with you and sharing with trusted training model so please get in touch for more information!



Contact your local rep to arrange a training webinar



We also host a series of educational webinars featuring guest speakers and industry professionals



Surgical Instrument Set Refurbishment at North Devon District Hospital

Surgical Holdings have been recently managing a refurbishment programme for North Devon District Hospital. Here is their report on the implementation and success of their refurbishment programme so far.

Background

North Devon District Hospital is part of the Northern Devon Healthcare NHS Trust and the theatre complex has an inventory in excess of 1000 sets. The majority of sets are owned by the trust but this is supplemented with "Loan and Consignment" Orthopaedic sets.

Need for Change

With the need for clinical efficiency and productivity in the theatres instrumentation is required to be efficient and fit for purpose.

Limited sets are being used with a high turnover affecting compliance, sharpness, tension, etc. New instruments are available to replace old, well used stock but the capital required for the instrumentation is hard to obtain.

Implementation

To offset the need for capital to fund instrument replacements the CSSD and Theatres took the decision to try the Surgical Holdings option of refurbishing the instruments sets rather than disposing and purchasing new instruments. Instruments will either be refurbished back to new quality or replaced with new items for an inclusive price.

A "Basic" set was delivered to Surgical Holdings on the understanding the returned set would be assessed by the theatre staff to ensure the returned items met the requirements of the clinical team; e.g. sharpness, tension, colour, glare (lack of), etc.

The set passed the test and the remaining 22 "Basic" sets were refurbished on a rolling plan, the benefit of sending one set away at a time ensured a maximum stock level was available for clinical use.

Following the success of the 22 "Basic" sets a further 10 Oral Surgery Sets have been refurbished to the same standard.

Currently we have a Large Ortho Basic back after refurbishment awaiting theatre approval.

Implications

Finance

- No capital required to fund purchase
- Revenue spend to fund refurbishment

CSSD

- Minimum of sets out of service due to rolling programme
- Less incomplete sets as items are like new on refurbished sets, not needing further repairs

Theatre Staff

- Increased Clinical confidence – instruments like new
- Not subject to shortage of sets during process
- Reduction in procurement process – process agreed then rolling work plan
- Clinical staff sign-off regarding quality



The refurbishment of the theatre sets has allowed high usage instrumentation to be brought back up to a standard equal to new, this has been met with appreciation from theatre staff and has ensured clinical requirement for sets has not been compromised.



Fraser Bishop, Facilities Clinical Services Manager Trust Decontamination Lead,
North Devon District Hospital



General Instruments

Artery Forceps	14
Clamps	17
Spring Forceps	19
Tissue Forceps	20
Sponge Holding and Sterilising Forceps	22
Other Forceps	23
Scissors	24
Needle Holders	29
Combined Scissor and Needle Holders	33
Bag and Towel Clips	34
Retractors	35
Dissectors and Probes	43
Miscellaneous	44
Hollow Ware	45
Silicone Matting	46
Sterilising Baskets	46
Optical Fibre Cables	48

Artery Forceps

Adson Artery Forceps

Box joint, 180mm long

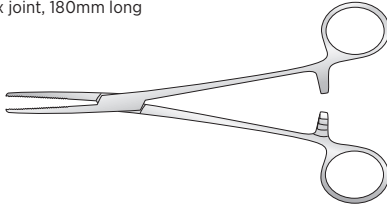

Serrated jaws

Code	Description
SC-GI/034	Straight
SC-GI/034a	Curved

1-2 teeth

Code	Description
SC-GI/034b	Straight
SC-GI/034c	Curved

Cushing Artery Forceps

Box joint, fine, half serrated jaws, 140mm long

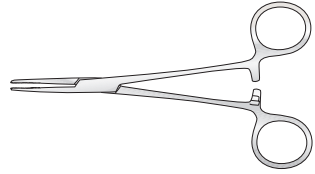

Code	Description
SC-GI/001	Straight
SC-GI/002	Curved

Cairns Artery Forceps

Box joint, half serrated jaws
145mm long

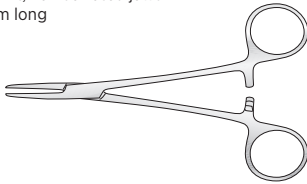

Serrated jaws

Code	Description
SC-GI/415	Straight

1-2 teeth

Code	Description
SC-GI/020	Curved
SC-GI/021	Curved to side

Dunhill Artery Forceps

Box joint, fine serrations

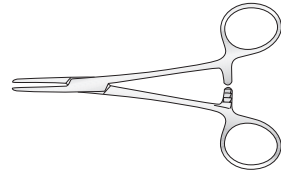

Straight

Code	Description
SC-GI/065	135mm long
SC-GI/065a	190mm long

Curved

Code	Description
SC-GI/043	135mm long
SC-GI/468	180mm long

Crile Artery Forceps

Box joint, serrated jaws

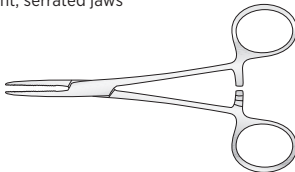

Straight

Code	Description
SC-GI/014	140mm long
SC-GI/014a	160mm long

Curved

Code	Description
SC-GI/015	140mm long
SC-GI/015a	160mm long

Lawson Tait Artery Forcep

Box joint, straight jaw

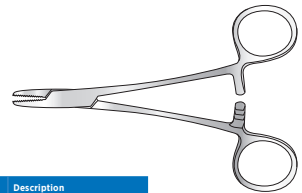

Code	Description
SC-GI/SH5924	140mm long

Halstead Mosquito Forceps

Standard pattern, haemostatic, box joint

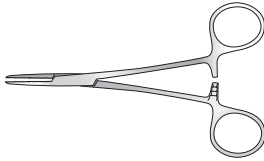

Serrated jaw

Code	Description
SC-GI/007	Straight 125mm long
SC-GI/008	Curved 125mm long
SC-GI/009	Fully curved 125mm long

1-2 teeth

Code	Description
SC-GI/010	Straight 125mm long
SC-GI/012	Straight 190mm long
SC-GI/011	Curved 125mm long
SC-GI/013	Curved 190mm long

Micro, 100mm long

Code	Description
SC-GI/003	Straight, serrated
SC-GI/004	Curved, serrated
SC-GI/005	Straight, 1-2 teeth
SC-GI/006	Curved, 1-2 teeth

Kelly Artery Forceps

Box joint, half serrated jaws



Straight

Code	Description
SC-GI/022	140mm long
SC-GI/023	160mm long

Curved

Code	Description
SC-GI/024	140mm long
SC-GI/025	160mm long

Fraser Kelly Artery Forceps Curved

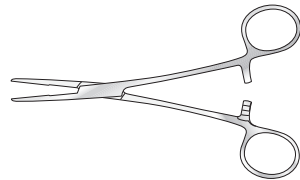

Straight

Code	Description
SC-GI/468a	180mm

Heiss Artery Forceps

Box joint, 205mm long

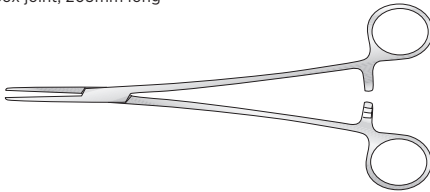

Serrated jaws

Code	Description
SC-GI/016	Straight
SC-GI/017	Curved

1-2 teeth

Code	Description
SC-GI/016a	Straight
SC-GI/017b	Curved

Kocher Artery Forceps

Box joint, 1-2 teeth

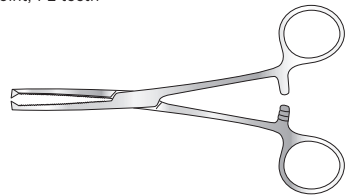

Straight

Code	Description
SC-GI/052	130mm long
SC-GI/053	150mm long
SC-GI/054	180mm long
SC-GI/055	200mm long
SC-GI/056	230mm long

Curved

Code	Description
SC-GI/057	150mm long
SC-GI/058	180mm long
SC-GI/059	200mm long
SC-GI/060	230mm long

Artery Forceps

Moynihan Artery Forceps

Box joint, half-serrated jaws

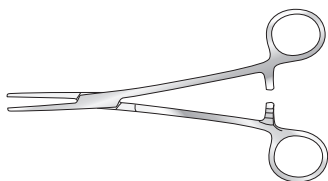

Straight

Code	Description
SC-GI/018	145mm long
SC-GI/068	180mm long

Curved

Code	Description
SC-GI/019	145mm long
SC-GI/069	180mm long

Rochester-Pean Artery Forceps

Box joint

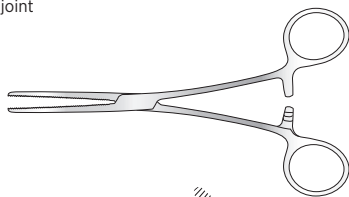

Straight

Code	Description
SC-GI/044	165mm long
SC-GI/045	190mm long
SC-GI/046	205mm long
SC-GI/047	240mm long

Curved

Code	Description
SC-GI/048	165mm long
SC-GI/049	180mm long
SC-GI/050	205mm long
SC-GI/051	240mm long

Roberts Artery Forceps

Screw joint, curved on flat, serrated

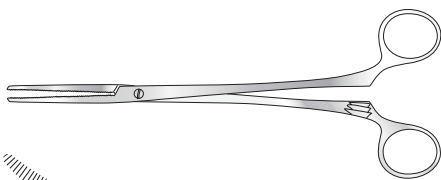

Code	Description
SC-GI/070	230mm long

Spencer Wells Artery Forceps

Box joint, serrated jaws

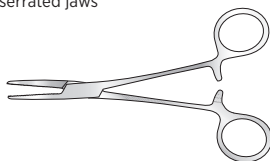

Straight

Code	Description
SC-GI/035	127mm long
SC-GI/036	152mm long
SC-GI/037	177mm long
SC-GI/038	203mm long

Curved

Code	Description
SC-GI/039	127mm long
SC-GI/040	152mm long
SC-GI/041	177mm long
SC-GI/042	203mm long

OTHER SIZES AVAILABLE

Dandy Artery Forceps

Box joint, curved in plane

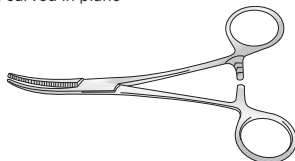

Code	Description
SC-GI/076	140mm long



Carmalt Angiotribe Forceps

Box joint, atraumatic, light pattern

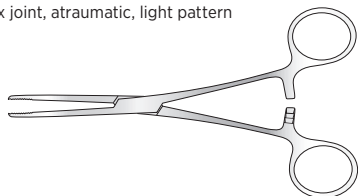

Straight

Code	Description
SC-GI/062	165mm long
SC-GI/063	200mm long
SC-GI/064	230mm long

Curved

Code	Description
SC-GI/061	165mm long

Dieffenbach Bulldog Clamp

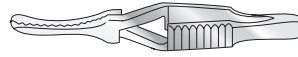

Straight, serrated

Code	Description
SC-GI/112	1.2mm fine jaw, 40mm long
SC-GI/113	1.2mm fine jaw, 45mm long
SC-GI/108	1.8mm jaw, 30mm long
SC-GI/109	1.8mm jaw, 35mm long
SC-GI/110	2.5mm jaw, 40mm long
SC-GI/111	2.5mm jaw, 45mm long
SC-GI/107	6mm heavy jaw, 60mm long
SC-GI/455	20mm jaw, 75mm long
SC-GI/455a	30mm jaw, 85mm long
SC-GI/455b	45mm jaw, 105mm long
SC-GI/455c	65mm jaw, 120mm long

Straight, plain

Code	Description
SC-GI/129	1.2mm fine jaw, 40mm long
SC-GI/131	1.2mm fine jaw, 45mm long
SC-GI/121	1.8mm jaw, 30mm long
SC-GI/123	1.8mm jaw, 35mm long
SC-GI/125	2.5mm jaw, 40mm long
SC-GI/127	2.5mm jaw, 45mm long

Curved, serrated

Code	Description
SC-GI/119	1.2mm fine jaw, 40mm long
SC-GI/120	1.2mm fine jaw, 45mm long
SC-GI/115	1.8mm jaw, 30mm long
SC-GI/116	1.8mm jaw, 35mm long
SC-GI/117	2.5mm jaw, 40mm long
SC-GI/118	2.5mm jaw, 45mm long
SC-GI/114	6mm heavy jaw, 60mm long
SC-GI/456	20mm jaw, 75mm long
SC-GI/456a	30mm jaw, 85mm long
SC-GI/456b	45mm jaw, 105mm long
SC-GI/456c	65mm jaw, 120mm long

Curved, plain

Code	Description
SC-GI/130	1.2mm fine jaw, 40mm long
SC-GI/132	1.2mm fine jaw, 45mm long
SC-GI/122	1.8mm jaw, 30mm long
SC-GI/124	1.8mm jaw, 35mm long
SC-GI/126	2.5mm jaw, 40mm long
SC-GI/128	2.5mm jaw, 45mm long

Blalock Bulldog Clamp



Serrated, with hole in handle

Straight

Code	Description
SC-GI/480	11mm jaw, 38mm long
SC-GI/482	14mm jaw, 48mm long
SC-GI/493	17mm jaw, 60mm long
SC-GI/481	27mm jaw, 70mm long

Curved

Code	Description
SC-GI/478	11mm jaw, 38mm long
SC-GI/479	14mm jaw, 48mm long
SC-GI/491	17mm jaw, 60mm long
SC-GI/492	27mm jaw, 70mm long

Plain, with hole in handle

Straight

Code	Description
SC-GI/486	11mm jaw, 38mm long
SC-GI/487	14mm jaw, 48mm long
SC-GI/488	17mm jaw, 60mm long
SC-GI/489	27mm jaw, 70mm long

Curved

Code	Description
SC-GI/483	11mm jaw, 38mm long
SC-GI/484	14mm jaw, 48mm long
SC-GI/485	17mm jaw, 60mm long
SC-GI/490	27mm jaw, 70mm long

An Overview On

Forcep Jaw Types

You will see that forceps in our catalogue will have either a traditional serrated jaw or a different design which is known as atraumatic (or non-traumatic).

Traditional Serrated Jaw



The traditional serrated jaw is generally more robust and used on forceps where the areas are not as delicate.

Atraumatic Jaw



Atraumatic jaws will be mainly found in delicate surgery areas such as vascular and cardiothoracic. The design is such, that the surface area gripped is reduced, ensuring less trauma without the loss of grip.

Spring Forceps

Adsons Dissecting Forceps

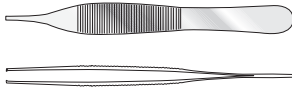

127mm long

Code	Description
SC-GI/257	1-2 teeth
SC-GI/258	Lightweight, micro
SC-GI/259	Serrated
SC-GI/260	Serrated, lightweight, micro

Block End Dissecting Forceps

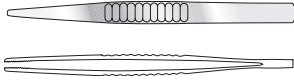

Serrated

Code	Description
SC-GI/255	127mm long
SC-GI/256	152mm long
SC-GI/256a	203mm long

Bonney Dissecting Forceps

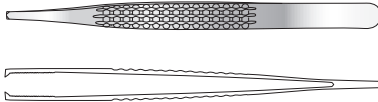

178mm long

Code	Description
SC-GI/267	Serrated, 1-2 teeth
SC-GI/268	1-2 teeth

Charnley-McIndoe Dissecting Forceps

150mm long

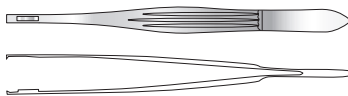

Code	Description
SC-OR/N045a	2-3 teeth

DeBakey Atraumatic Dissecting Forceps

Straight, atraumatic jaws

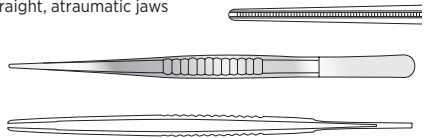

1.5mm

Code	Description
SC-GI/238a	150mm long
SC-GI/240a	240mm long

2.5mm

Code	Description
SC-GI/238b	150mm long
SC-GI/240b	240mm long

2mm

Code	Description
SC-GI/238	150mm long
SC-GI/241	180mm long

2.8mm

Code	Description
SC-GI/238c	150mm long
SC-GI/240c	240mm long
SC-GI/241c	180mm long

Dissecting Forceps

Turnover end, serrated jaws

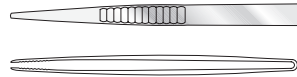

Code	Description
SC-GI/242	127mm long
SC-GI/243	152mm long

Code	Description
SC-GI/244	178mm long
SC-GI/245	203mm long

Dunhill Dissecting Forceps

Light, fine serrated jaws



Code	Description
SC-GI/457	145mm long

Fredrick Coole Dissecting Forceps

Extra fine serrated jaws

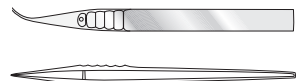

125mm long

Code	Description
SC-GI/066	Straight
SC-GI/067	Curved

Gillies Dissecting Forceps

1-2 teeth

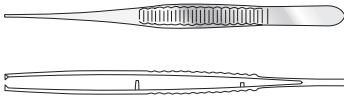

Code	Description
SC-PL/052	152mm long

McIndoe Dissecting Forceps

152mm long

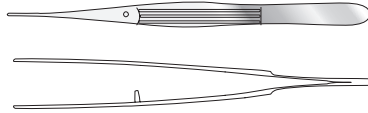

Code	Description
SC-GI/476	Serrated
SC-GI/477	1-2 teeth

Jackson Burrows Dissecting Forceps

140mm long

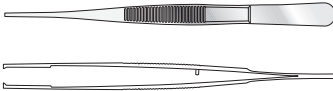

Code	Description
SC-OR/N037	Tongue and groove, 1-2 teeth
SC-OR/N037a	Tongue and groove only

McIndoe Modified Dissecting Forceps

152mm long, 1mm tip, modified for fine powerful dissection with strong action tip



Code	Description
SH/5961	Serrated

Jean Dissecting Forceps

Serrated jaws, 140mm long

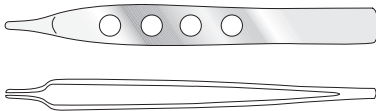

Code	Description
SC-GI/269	Fine
SC-GI/270	1-2 teeth
SC-GI/271	2-3 teeth, 178mm long

Treves Dissecting Forceps

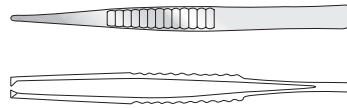

1-2 teeth

Code	Description
SC-GI/251	127mm long
SC-GI/252	152mm long

2-3 teeth

Code	Description
SC-GI/253	127mm long
SC-GI/254	152mm long

Lanes Dissecting Forceps

1-2 teeth on serrated jaws, 140mm long

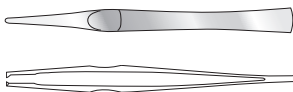

Code	Description
SC-GI/246	127mm long
SC-GI/247	152mm long
SC-GI/248	178mm long

Code	Description
SC-GI/249	2-3 teeth, 178mm long
SC-GI/250	2-3 teeth 203mm long

Waugh Dissecting Forceps

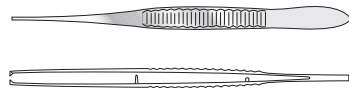

Fine, serrated

Code	Description
SC-GI/261	152mm long
SC-GI/262	178mm long
SC-GI/263	203mm long

Fine, 1-2 teeth

Code	Description
SC-GI/264	152mm long
SC-GI/265	178mm long
SC-GI/266	203mm long

Tissue Forceps

Allis Tissue Forceps

Box joint

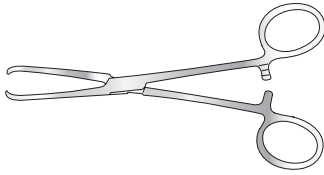

150mm long

Code	Description
SC-GI/272	3-4 teeth
SC-GI/273	4-5 teeth

190mm long

Code	Description
SC-GI/414	5-6 teeth

Duval Tissue Forceps

Box joint

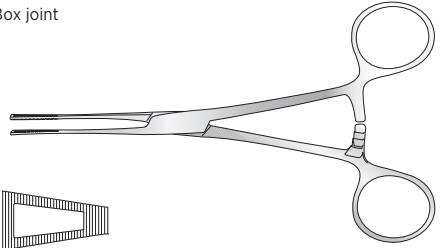

Code	Description
SC-GI/279	13mm wide, 203mm long

Littlewood Tissue Forceps

Box joint, 2-3 teeth

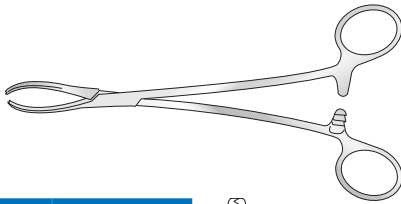

Code	Description
SC-GI/275	190mm long

Lane Tissue Forceps

Box joint, 1-2 teeth, fenestrated

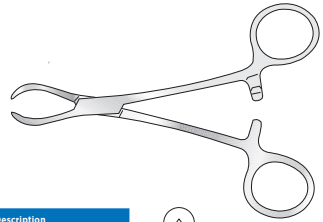

Code	Description
SC-GI/280	127mm long
SC-GI/281	152mm long
SC-GI/282	197mm long

Babcock Tissue Forceps

Box joint, serrated jaws

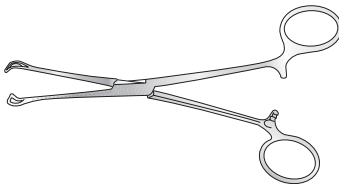

Code	Description
SC-GI/276	160mm long
SC-GI/277	200mm long
SC-GI/278	230mm long

Rutherford Morrison Tissue Forceps

Box joint

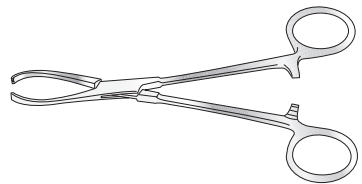

Code	Description
SC-GI/283	4-5 teeth, 152mm long

Shaw Tissue Forceps

Box joint

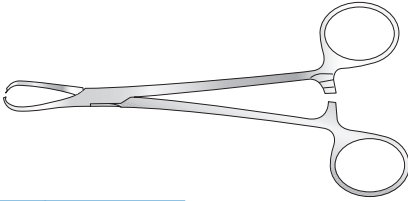

Code	Description
SC-GI/458	1-2 teeth, 178mm long



Guys Gallabin Suture-Holding Forceps

Screw joint, angled flat blades

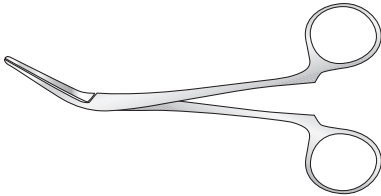

Code	Description
SC-GI/450	125mm long
SC-GI/4402	150mm long

Russian Dissecting Forceps

With fenestrated end

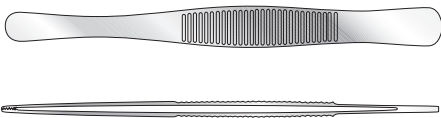

Code	Description
SC-GI/SH-5503b	150mm long
SC-GI/SH-5503	200mm long
SC-GI/403	230mm long
SC-GI/SH-5503a	250mm long



Special Offer

on SSD Essentials Pack

Top up your trays with these essentials...

CONTACT US FOR OUR OFFER PRICE

Halstead Mosquito Forceps

Straight/Curved
125mm (5")

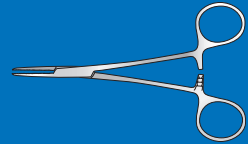

Ramsey Sponge Holding Forceps

Straight, Serrated
Jaws 241mm
(9 1/2")

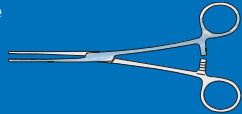

Scalpel Blade Handle

No. 3



Spring Clip

Serrated Pattern,
Stainless Steel for
Fixing Slings to Leg
Splints, also for
Towel Clipping
6.3cm (2 1/2") Wide

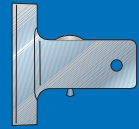

Spencer Wells Artery Forceps

Straight, Serrated
Jaws

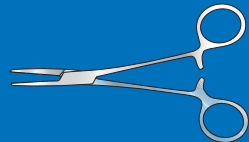

Email us to place your order

info@surgicalholdings.co.uk

Sponge Holding and Sterilising Forceps

Rampléy Sponge Holding Forceps

Box joint, straight, serrated jaws

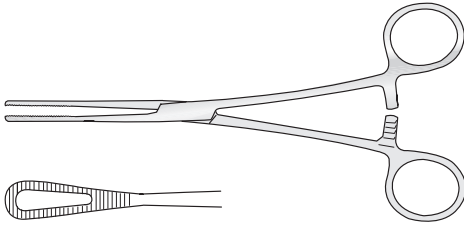

Code	Description
SC-GI/353	178mm long
SC-GI/354	241mm long

Lister Sinus Forceps

Box joint, serrated tip

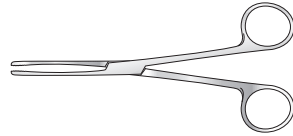

Code	Description
SC-GI/367	127mm long
SC-GI/368	152mm long
SC-GI/369	178mm long

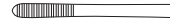

Foerster Sponge Holding Forceps

Box joint, straight, serrated jaws

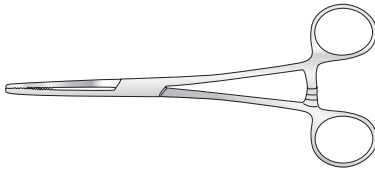

Code	Description
SC-GI/354a	178mm long



Cheatle Sterilizer Forceps

Screw joint

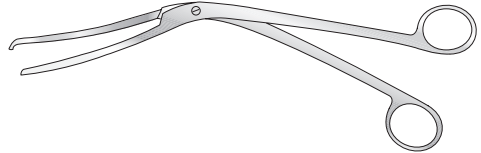

Code	Description
SC-GI/364	267mm long

Harrison Bowl Steriliser Forceps

Screw joint, angled, double jaw

Code	Description
SC-GI/365	356mm long
SC-GI/366	457mm long

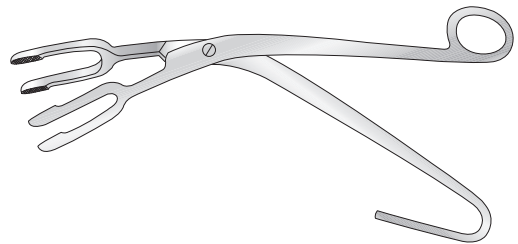

Hunter Splinter Forceps

Serrated grooved pointed jaws



Code	Description
SC-GI/360	115mm long

Michel Forceps

Box joint, double-ended, for inserting and removing clips stainless steel

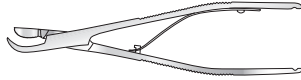

Code	Description
SC-GI/357	130mm long

Michel Skin Holding Forceps

With magazine for Michel clips

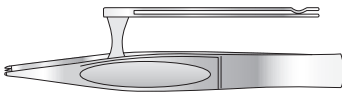

Code	Description
SC-GI/358	1-2 teeth, 127mm long

Michel Clip Extracting Forceps

Box joint

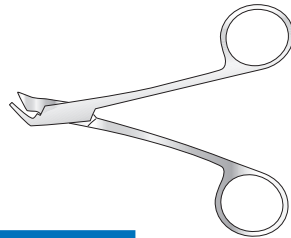

Code	Description
SC-GI/359	125mm long

Childe Approximating Forceps

With magazine for Michel clips

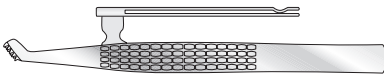

Code	Description
SC-GI/469	180mm long

Robins Anchoring Forceps

140mm long

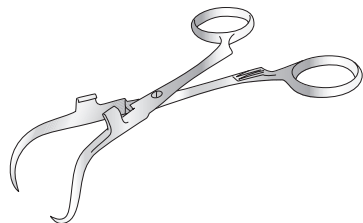

Code	Description
SC-GI/453	5mm with holder for diathermy leads
SC-GI/453a	13mm with holder for suction tubing

Premium Quality Stainless Steel Scissors

Dressing Scissors



Blunt/Blunt

Straight

Code	Description
SC-GI/133	130mm long
SC-GI/136	146mm long
SC-GI/139	165mm long

Curved

Code	Description
SC-GI/142	130mm long
SC-GI/143	146mm long
SC-GI/144	165mm long
SC-GI/145	185mm long
SC-GI/404	147mm long

With one serrated blade

Blunt/Sharp

Straight

Code	Description
SC-GI/134	130mm long
SC-GI/137	146mm long
SC-GI/140	165mm long

Sharp/Sharp

Straight

Code	Description
SC-GI/135	130mm long
SC-GI/138	146mm long
SC-GI/141	165mm long

Curved

Code	Description
SC-GI/146	130mm long

Metzenbaum Scissors

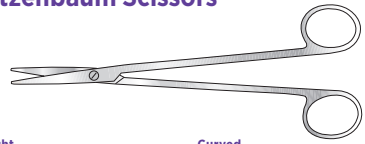

Straight

Code	Description
SC-GI/405	180mm long
SC-GI/406	147mm long
SC-GI/406a	200mm long
SC-GI/406b	230mm long
SC-GI/406c	250mm long
SC-GI/406d	280mm long

Curved

Code	Description
SC-GI/407	185mm long
SC-GI/408	147mm long
SC-GI/408a	200mm long
SC-GI/408b	230mm long
SC-GI/408c	250mm long
SC-GI/408d	280mm long

Dressing Scissors, Left-Handed

With one black bow, 145mm long

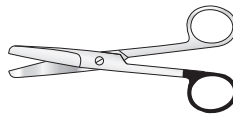

Blunt/Blunt

Code	Description
SC-GI/192	Straight
SC-GI/193	Curved

Blunt/Sharp

Code	Description
SC-GI/194	Straight
SC-GI/195	Curved

Sharp/Sharp

Code	Description
SC-GI/196	Straight
SC-GI/197	Curved

Mayo Scissors



Straight

Code	Description
SC-GI/409	140mm long
SC-GI/409a	160mm long
SC-GI/411	190mm long
SC-GI/411a	230mm long

Curved

Code	Description
SC-GI/410	140mm long
SC-GI/410a	160mm long
SC-GI/412	190mm long
SC-GI/412a	230mm long

Ferguson Scissors

Angled on flat

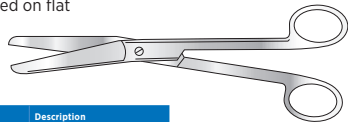

Code	Description
SC-GI/148	180mm long

Little Dissecting Scissors

Fine pattern, with eye for suture

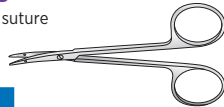

Code	Description
SC-PL/001f	115mm long

Paynes Suture Scissors

Code	Description
SC-GI/152	100mm long

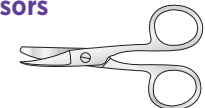

Kilner Dissecting Scissors

Fine pattern



Code	Description
SC-PL/001a	115mm long

Ligature Stitch Scissors

Fine pattern

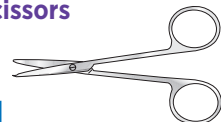

Code	Description
SC-GI/153	115mm long



Lister Bandage Scissors

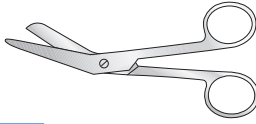

Code	Description
SC-GI/154	147mm long
SC-GI/155	178mm long

Lister Bandage Scissors

Angled, with probe end

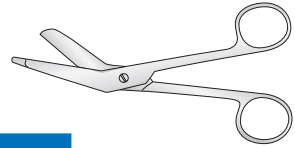

Code	Description
SC-GI/361	147mm long
SC-GI/362	178mm long

McIndoe Scissors

178mm long

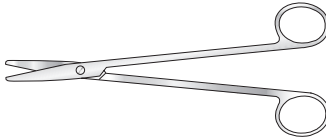

Code	Description
SC-GI/149	Straight
SC-GI/150	Curved on flat
SC-GI/150sc	Supercut, curved



Thomas Strabismus Scissors

114mm long

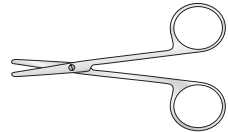

Code	Description
SC-OP/030	Straight
SC-OP/029	Curved

Heath Stitch Scissors

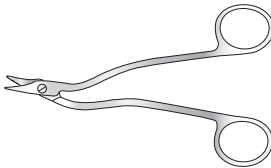

Code	Description
SC-GI/151	152mm long

“Careless” Scissors

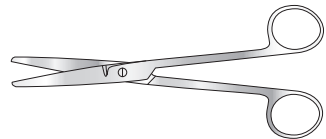

Code	Description
SC-GI/474	165mm long

Tubing Scissors

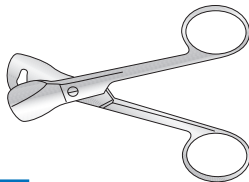

Code	Description
SC-GI/147	130mm long

Utility Scissors



Code	Description
SC-GI/466	190mm long

Tungsten Carbide Hard Insert Scissors

Dressing Scissors

Tungsten carbide hard insert,
blunt/blunt

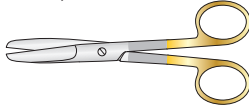

Straight

Code	Description
SC-GI/430	130mm long
SC-GI/432	145mm long
SC-GI/434	165mm long
SC-GI/436	185mm long

Curved

Code	Description
SC-GI/431	130mm long
SC-GI/433	145mm long
SC-GI/435	165mm long

Mayo Dressing Scissors

Tungsten carbide hard insert

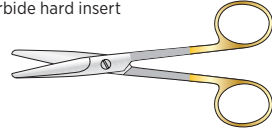

Straight

Code	Description
SC-GI/419	140mm long
SC-GI/419a	160mm long
SC-GI/421	190mm long
SC-GI/421a	230mm long

Curved

Code	Description
SC-GI/420	140mm long
SC-GI/420a	160mm long
SC-GI/422	190mm long
SC-GI/422a	230mm long

Dressing Scissors

Tungsten carbide hard insert,
blunt/sharp

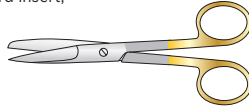

Straight

Code	Description
SC-GI/423	130mm long
SC-GI/425	145mm long
SC-GI/427	165mm long
SC-GI/429	185mm long

Curved

Code	Description
SC-GI/424	130mm long
SC-GI/426	145mm long
SC-GI/428	165mm long

Mayo-Harrington Dressing Scissors

Tungsten carbide hard insert

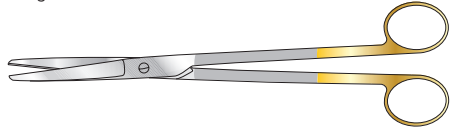

230mm long

Code	Description
SC-GI/417	Straight
SC-GI/418	Curved

200mm long

Code	Description
SC-GI/162a	Straight
SC-GI/413b	Curved

Dressing Scissors

Tungsten carbide hard insert sharp/sharp

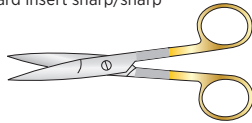

Straight

Code	Description
SC-GI/437	130mm long
SC-GI/439	145mm long
SC-GI/441	165mm long
SC-GI/443	185mm long

Curved

Code	Description
SC-GI/438	130mm long
SC-GI/440	145mm long
SC-GI/442	165mm long

Metzenbaum Scissors

Tungsten carbide hard insert

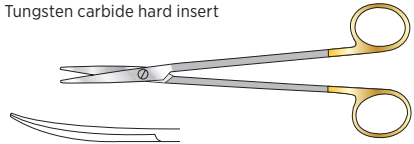

230mm long

Code	Description
SC-GI/445	145mm long
SC-GI/447a	185mm long
SC-GI/471a	230mm long
SC-GI/471b	250mm long
SC-GI/471c	280mm long

200mm long

Code	Description
SC-GI/446	145mm long
SC-GI/449	185mm long
SC-GI/449a	200mm long
SC-GI/449b	230mm long
SC-GI/449c	250mm long
SC-GI/449d	280mm long

Baby Metzenbaum Scissors

Tungsten carbide,
hard insert, 145mm long

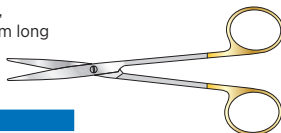

Code	Description
SC-GI/445a	Straight
SC-GI/446a	Curved

Ligature Scissors

Tungsten carbide
hard insert, curved

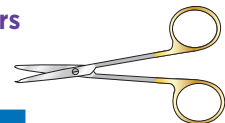

Code	Description
SC-GI/444	145mm long
SC-GI/447	185mm long

Tungsten Carbide Supercut Scissors

Mayo Harrington Scissors

Supercut, tungsten carbide

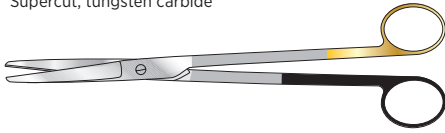

230mm long

Code	Description
SC-GI/162	Straight
SC-GI/413	Curved

200mm long

Code	Description
SC-GI/162b	Straight
SC-GI/413b	Curved

Mayo Scissors

Supercut, tungsten carbide

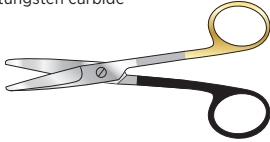

Straight

Code	Description
SC-GI/163	140mm long
SC-GI/163a	160mm long
SC-GI/165	190mm long
SC-GI/165a	230mm long

Curved

Code	Description
SC-GI/164	140mm long
SC-GI/164a	160mm long
SC-GI/166	190mm long
SC-GI/166a	230mm long

Metzenbaum Dissecting Scissors

Supercut, tungsten carbide

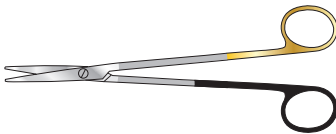

Straight

Code	Description
SC-GI/188tc	185mm long
SC-GI/188tca	200mm long
SC-GI/188tcb	230mm long
SC-GI/188tcc	250mm long
SC-GI/188tcd	280mm long

Curved

Code	Description
SC-GI/191tc	147mm
SC-GI/189tc	185mm
SC-GI/186tca	200mm
SC-GI/188tcb	230mm
SC-GI/188tcc	250mm
SC-GI/188tcd	280mm

Dressing Scissors

Supercut, tungsten carbide



Blunt/Blunt

Straight

Code	Description
SC-GI/174	130mm long
SC-GI/176	145mm long
SC-GI/178	165mm long
SC-GI/180	185mm long

Curved

Code	Description
SC-GI/175	130mm long
SC-GI/177	145mm long
SC-GI/179	165mm long
SC-GI/180a	185mm long

Blunt/Sharp

Straight

Code	Description
SC-GI/167	130mm long
SC-GI/169	145mm long
SC-GI/171	165mm long
SC-GI/173	185mm long

Curved

Code	Description
SC-GI/168	130mm long
SC-GI/170	145mm long
SC-GI/172	165mm long
SC-GI/173a	185mm long

Sharp/Sharp

Straight

Code	Description
SC-GI/181	130mm long
SC-GI/183	145mm long
SC-GI/185	165mm long
SC-GI/187	185mm long

Curved

Code	Description
SC-GI/182	130mm long
SC-GI/184	145mm long
SC-GI/186	165mm long
SC-GI/187a	185mm long

Guide for Gold and Black Bows

It's important to know the difference for the intended use of each scissor:



2 Gold Bows
Tungsten carbide insert or padding for a scissor



2 Black Bows
Supercut edge



1 Black and 1 Gold Bow
Supercut tungsten carbide



1 Black Bow (left ring)
Left-handed instrument carbide

Supercut Operating Scissors

i WITH TWO BLACK BOWS FOR IDENTIFICATION

Dressing Scissors

Supercut, blunt/blunt



145mm long

Code	Description
SC-GI/160	Straight
SC-GI/161	Curved

Dressing Scissors

Supercut, blunt/sharp



145mm long

Code	Description
SC-GI/156	Straight
SC-GI/157	Curved

Dressing Scissors

Supercut, sharp/sharp



145mm long

Code	Description
SC-GI/158	Straight
SC-GI/159	Curved

Mayo Scissors

Supercut



Straight

Code	Description
SC-GI/166a	140mm long
SC-GI/166e	160mm long
SC-GI/166b	170mm long

Curved

Code	Description
SC-GI/166c	140mm long
SC-GI/166f	160mm long
SC-GI/166d	170mm long

Boyd Scissors

Supercut, blunt/blunt

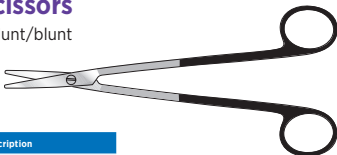

Code	Description
SC-THO/047	180mm long

Metzenbaum Dissecting Scissors

Supercut

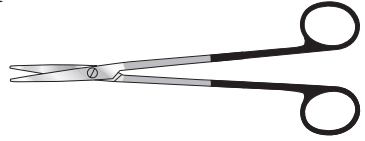

Straight (length)

Code	Description
SC-GI/190	147mm
SC-GI/188	185mm
SC-GI/188a	200mm
SC-GI/188b	230mm
SC-GI/188c	250mm
SC-GI/188d	280mm

Curved (length)

Code	Description
SC-GI/191	147mm
SC-GI/189	185mm
SC-GI/186a	200mm
SC-GI/186b	230mm
SC-GI/186c	250mm
SC-GI/186d	280mm

Stevens Tenotomy Scissors

Supercut



Curved/blunt

Code	Description
SC-OP/424	114mm long
SC-OP/424a	125mm long
SC-OP/424gb	135mm long

Curved/sharp

Code	Description
SC-OP/425	114mm long
SC-OP/425a	140mm long
SC-OP/425b	160mm long

Code

Description

SC-OP/426	Straight/blunt, 114mm long
SC-OP/427	Straight/sharp, 114mm long
SC-OP/427c	Straight/sharp, 180mm long

With cutout, 110mm long

Code	Description
SC-OP/427a	Straight/blunt
SC-OP/427b	Curved/blunt

Strabismus Scissors

Supercut



114mm long

Code	Description
SC-GI/475	Straight
SC-GI/475a	Curved

Iris Scissors

Supercut



114mm long

Code	Description
SC-OP/476	Straight
SC-OP/476a	Curved

Bruce Clarke Needle Holder

Screw joint

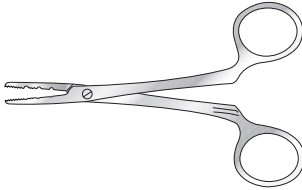

Code	Description
SC-GI/205	127mm long

Lawrence Needle Holder

Fine jaw, 150mm long

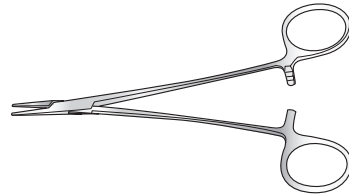

Code	Description
SC-PL/012a	
SC-PL/012b	Tungsten carbide jaw

Crile-Wood Needle Holder

Straight, baby, fine

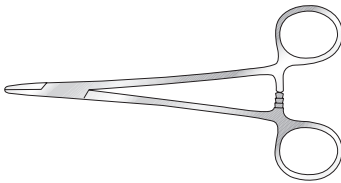

Code	Description
SC-GI/199	150mm long

Needle Holder

Surgical Holdings pattern, box joint, lightweight, with curved plain jaws and one offset bow for thumb

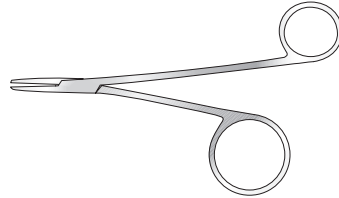

Code	Description
SC-GI/209	152mm long

Kilner Needle Holder

Box joint, cross-serrated jaw

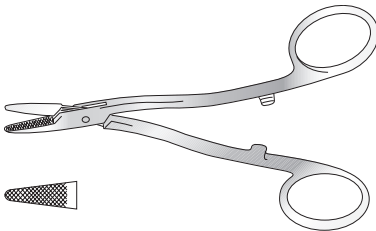

Code	Description
SC-GI/200	165mm long
SC-GI/201	133mm long

MacPhail Needle Holder

Screw joint, with one copper jaw

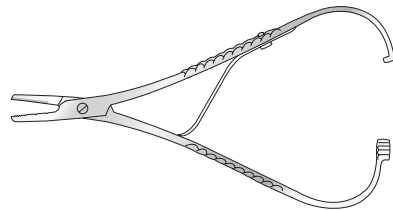

Code	Description
SC-GI/206	159mm long
SC-GI/207	178mm long
SC-GI/208	209mm long

Needle Holders

Mathieu Needle Holder

Screw joint

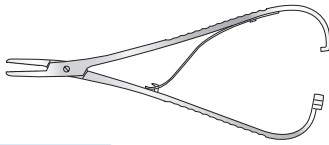

Code	Description
SC-GI/210	172mm long
SC-GI/211	209mm long
SC-GI/212	243mm long

Naughton Morgan Needle Holder

Box joints, cross serrated jaws

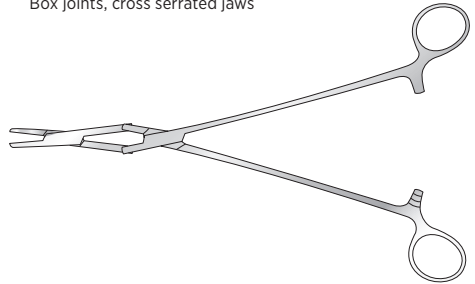

Mayo Needle Holder

Box joint, straight

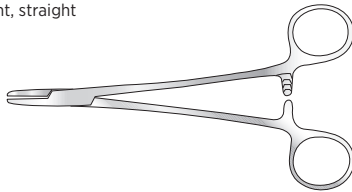

Wide cross serrated jaws

Code	Description
SC-GI/224	159mm long
SC-GI/398	203mm long



Narrow cross serrated jaws

Code	Description
SC-GI/225	159mm long

Tungsten carbide

Code	Description
SC-GI/399	185mm long
SC-GI/400	254mm long

Code	Description
SC-GI/401	185mm long
SC-GI/402	254mm long

Rochester-Mayo Needle Holder

Screw joint

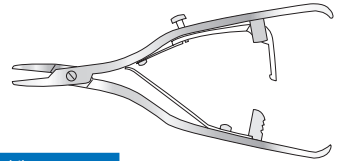

Code	Description
SC-GI/213	178mm long

Choosing the most suitable needle size

Our tungsten carbide inserts are available in a variety of styles. Choosing the most suitable needle size for each procedure helps give the surgeon maximum grip and control.

Coarse 0.65mm

For powerful needle holder patterns and wire twisters. Maximum holding capabilities for heavy needles or wire.



Micro 0.2-0.3mm

For micro needle holders such as Castroviejo, Microvascular and Mini-Ryder. For delicate needles and sutures between 7-0 and 10-0.



Standard 0.5mm

Used, for example, in Mayo-Hegar, Mathieu Needle Holders. For needles 3-0 and larger.



Smooth

Smooth tungsten carbide surface reduces damage to delicate needles and suture of 6-0 and finer.



Fine 0.4mm

For delicate needle holders such as Crile-Wood and DeBakey. For needles and sutures between 4-0 and 6-0.





WITH TWO GOLD BOWS
FOR IDENTIFICATION

Tungsten Carbide Needle Holders

Berry Needle Holder/Wire Twister

Tungsten carbide jaws

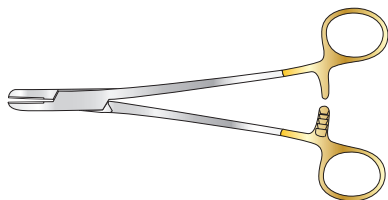

Code	Description
SC-GI/467	200mm long

Finochietto Needle Holder

Tungsten carbide jaws

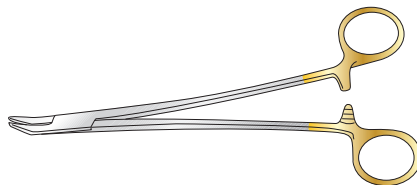

Code	Description
SC-GI/222	215mm long
SC-GI/223	265mm long

Crile-Wood Needle Holder

Tungsten carbide insert, box joint, satin finish, straight

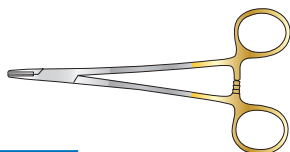

Code	Description
SC-GI/217	159mm long
SC-GI/218	178mm long
SC-GI/198	150mm long

Halsey Needle Holder

Tungsten carbide insert, box joint, satin finish, straight

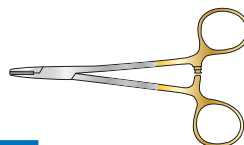

Code	Description
SC-GI/220	127mm long

Derf Needle Holder

Tungsten carbide insert



Code	Description
SC-GI/BUPHF002	115mm long

Kilner Needle Holder

Tungsten carbide insert

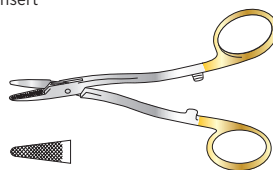

Code	Description
SC-GI/221	140mm long

Tungsten Carbide Needle Holders

i WITH TWO GOLD BOWS FOR IDENTIFICATION

Masing Needle Holder

Tungsten carbide insert, one angled bow

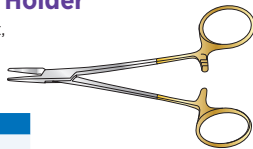

Code	Description
SC-GI/009R	130mm long

Nievert Needle Holder

Tungsten carbide insert, box joint, satin finish, straight

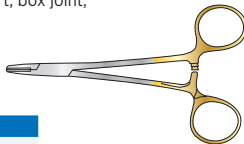

Code	Description
SC-GI/219	127mm long

DeBakey Needle Holder

250mm long

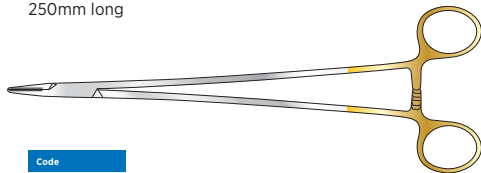

Code
THO/SC-5642a

Ryder Needle Holder

Tungsten carbide insert, box joint, satin finish, straight

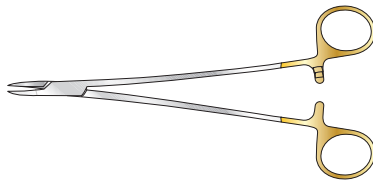

0.2mm jaw pitch

Code	Description
SC-GI/SH-5197a	135mm long
SC-GI/SH-5197b	155mm long
SC-GI/SH-5197c	175mm long
SC-GI/SH-5197d	210mm long

0.4mm jaw pitch

Code	Description
SC-GI/SH-5198a	135mm long
SC-GI/SH-5198b	155mm long
SC-GI/SH-5198c	175mm long
SC-GI/SH-5198d	210mm long

Sarot Needle Holder

Diamond jaw, tungsten carbide, gold plated bows

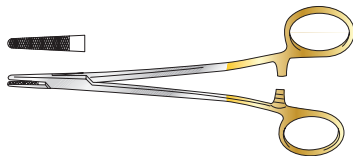

Code	Description
SC-GI/451	181mm long

Mayo-Hegar Needle Holder

Tungsten carbide insert, box joint, satin finish, straight

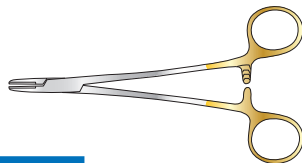

Code	Description
SC-GI/472	130mm long
SC-GI/214	159mm long
SC-GI/215	178mm long
SC-GI/216	209mm long

LONGER SIZES AVAILABLE

Tungsten Carbide Needle Holders

Features and Benefits

Jaw

Tungsten carbide inserts bonded into the jaws for a long lasting, secure grip

Bevelled Edges

Prevents suture from snagging

Laser Etching

Date and catalogue number are etched for easy re-ordering. Laser etch will not harm instrument like traditional methods

Satin Finish

Reduces glare

Ratchets

Precisely cut for effortless locking/unlocking

Teeth

Fine, hard teeth, diamond cut into an insert of hardened tungsten carbide for superior needle grasping and suture tying capabilities

Vacuum Brazing

Combines bonding of the tungsten carbide insert with the simultaneous vacuum hardening of the instrument for greater durability and longevity

Shanks

Precision balanced for comfort and control

Gold Handles

For easy identification

Combined Scissor and Needle Holders

Olsen-Hegar Scissor/Needle Holder

With tungsten carbide insert

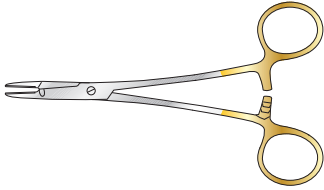

Code	Description
SC-GI/229	147mm long
SC-GI/230	165mm long

Olsen-Hegar Scissor/Needle Holder

Screw joint

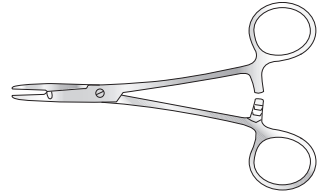

Code	Description
SC-GI/226	140mm long
SC-GI/227	165mm long
SC-GI/228	190mm long

Gillies Scissor/Needle Holder

Right-hand, with tungsten carbide insert

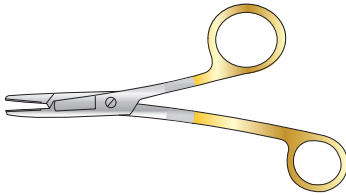

Code	Description
SC-GI/235	158mm long

Gillies Scissor/Needle Holder

Heavy pattern, 158mm long

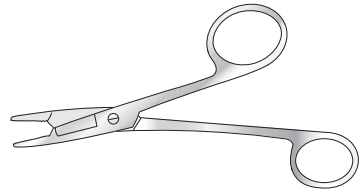

Code	Description
SC-GI/233	Right-hand
SC-GI/234	Left-hand

Gillies Scissor/Needle Holder

158mm long

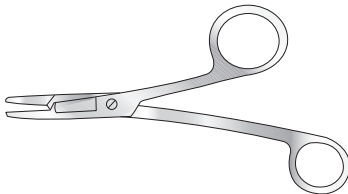

Code	Description
SC-GI/231	Right-hand
SC-GI/232	Left-hand

Foster Gillies Scissor/Needle Holder

Fine pattern



Code	Description
SC-GI/236	127mm long

Bag and Towel Clips

Spring Clip

Serrated pattern, stainless steel, for fixing slings to leg splints, also for towel clipping

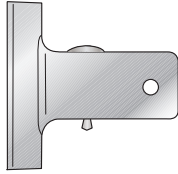

Code	Description
SC-GI/344	63mm wide

Spring Bag Clip

Serrated



Code	Description
SC-GI/345	26mm wide

Jones Towel Clip

Superior quality spring forcep type

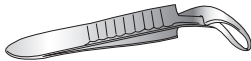

Code	Description
SC-GI/346	89mm long

Shardles Towel Clip

Spring curved, cross action



Code	Description
SC-GI/347	77mm long

Backhaus Towel Clip

Superior quality, box joint

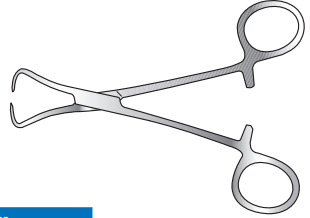

Code	Description
SC-GI/348	89mm long
SC-GI/348a	102mm long
SC-GI/349	130mm long

Moynihan Towel Clip

Screw joint, 2-2 teeth, for sides of incision

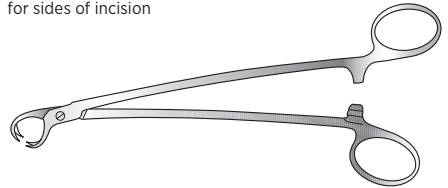

Code	Description
SC-GI/470	191mm long

Ball and Socket Towel Forceps

Box joint

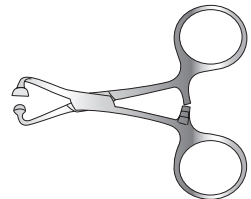

Code	Description
SC-GI/350	89mm long
SC-GI/351	115mm long
SC-GI/352	140mm long

Goligher Retractor

Complete with 2 centre blades:
1 x 90mm wide x 50mm deep
1 x 90mm wide x 90mm deep

and 2 pairs of lateral blades:
1 pair 25mm wide x 45mm deep
1 pair 50mm wide x 90mm deep

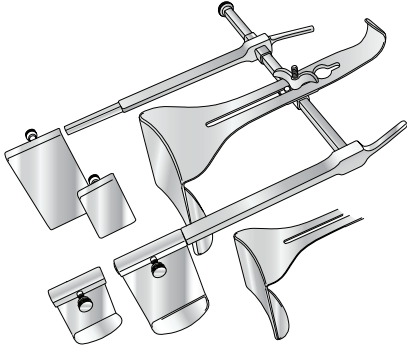

Code
SC-GI/305

Balfour Abdominal Retractor

Trivalve, frame 203mm

Child

102mm opening, 51mm deep lateral blades,
38mm deep centre blade

Adult

178mm opening, 64mm deep lateral blades,
44mm deep centre blade

Extra large

178mm opening, 102mm deep lateral blades,
108mm deep centre blade

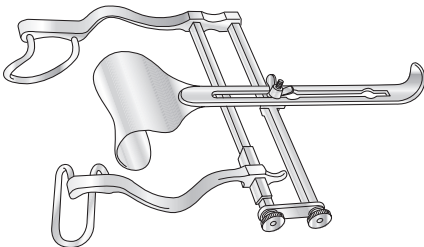

Code	Description
SC-GI/373	Child
SC-GI/374	Adult
SC-GI/375	Extra large

Miles Retractor

Complete with 2 centre blades:
1 x 90mm wide x 50mm deep
1 x 90mm wide x 75mm deep

and 2 pairs of lateral blades:
1 pair 80mm wide x 35mm deep
1 pair 80mm wide x 75mm deep

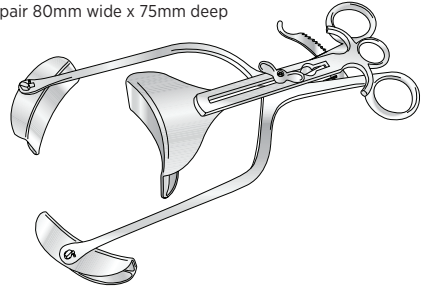

Code	Description
SC-GI/376	340mm long

OTHER BLADE SIZES AVAILABLE

Balfour Abdominal Retractor

Bivalve, baby

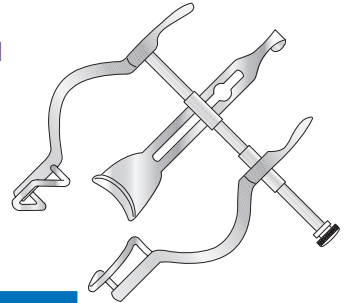

Code	Description
SC-GI/372	Fully open 89mm

Berkeley Abdominal Retractor

Parallel action

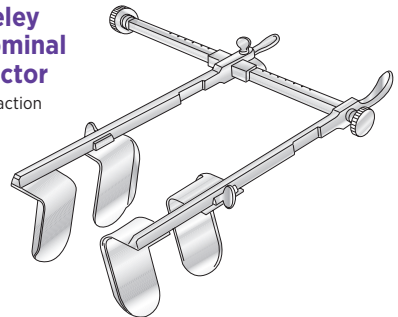

Code	Description
SC-GI/461	Blades 35mm x 60mm deep, 215mm long

Turner Warwick Retractors

Turner Warwick Universal Self Retaining Retractor

Code	Description
SC-GI/520	With frames A/B/C/D and blades A/B/C/D/E/F/K/L
SC-GI/521-A	Circular frame A only 178mm
SC-GI/521-B	Circular frame B only 229mm
SC-GI/521-C	Circular frame C only 305mm
SC-GI/521-D	Oval frame D only 475mm x 330mm
SC-GI/521-E	Oval frame E only 370mm x 300mm

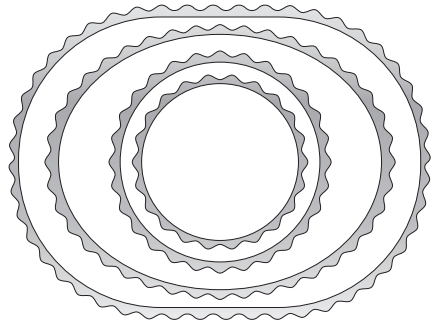

Turner Warwick Needleholder with Tungsten Carbide Jaws

Curved shanks with one short bow

Code	Description
SH-5835	230mm long
SH-5835A	200mm long

Blade A



Code	Description
SC-GI/522-A	Blade only - 19mm x 76mm

Blade B

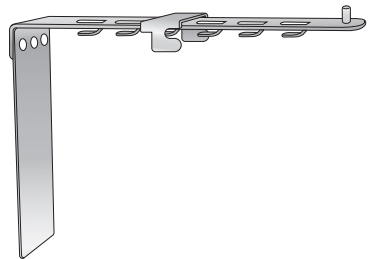

Code	Description
SC-GI/522-B	Blade only - 38mm x 102mm

Blade C

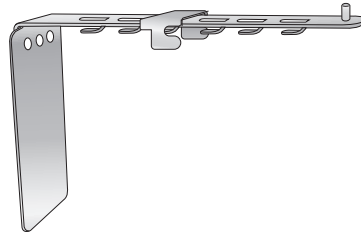

Code	Description
SC-GI/522-C	Blade only - 57mm x 89mm

Blade D

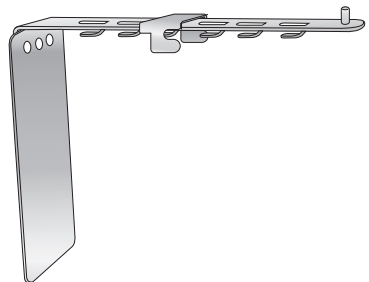

Code	Description
SC-GI/522-D	Blade only - 57mm x 114mm

Blade E

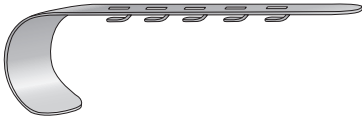

Code	Description
SC-GI/522-E	Blade only - curved stainless steel blade 51mm x 38mm

Blade F

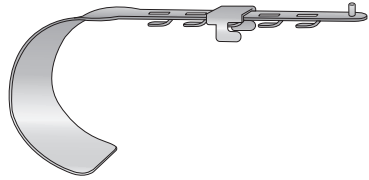

Code	Description
SC-GI/522-F	Blade only - curved stainless steel blade 76mm x 60mm

Blade G

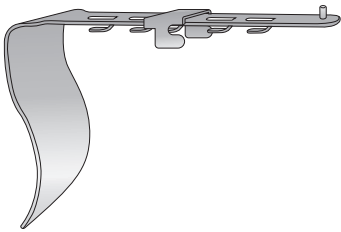

Code	Description
SC-GI/522-G	Blade only - flat stainless steel blade 89mm x 60mm

Blade J



Code	Description
SC-GI/522-J	Blade only - single hook, 13mm deep

Blade K

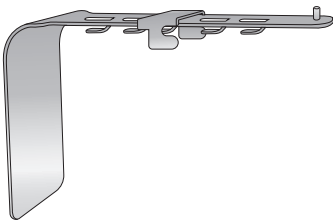

Code	Description
SC-GI/522-K	Blade only - flat with clip 55mm x 90mm

Blade L

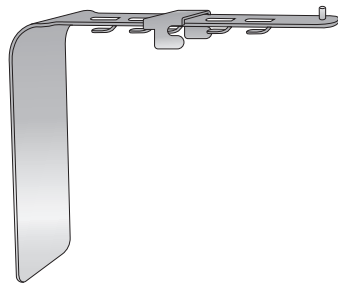

Code	Description
SC-GI/522-L	Blade only - flat with clip 55mm x 120mm

Retractors

Collin Retractor

110mm fully open, 235mm long

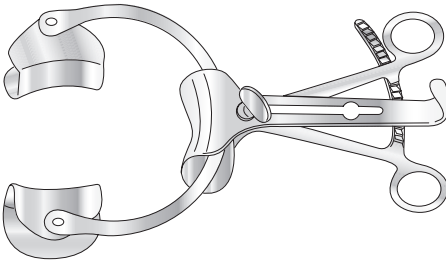

Code	Description
SC-GI/322	Complete with centre blade 55 x 40mm and one pair of blades 38mm x 60mm
SC-GI/322a	Without centre blade

Gelpi Retractor

Self retaining

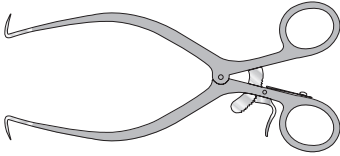

Code	Description
SC-GY/013a	140mm long
SC-GY/013b	178mm long

Joll Thyroid Retractor

Self retaining, with lock-in nut

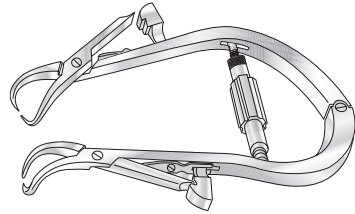

Code	Description
SC-GI/363	152mm long

Gossett Abdominal Retractor

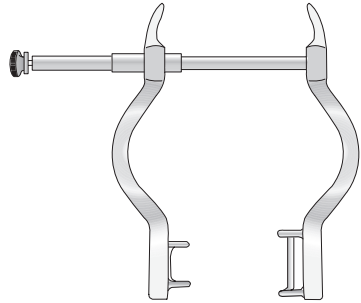

Code	Description
SC-GI/303	Large, fully open 185mm long
SC-GI/304	Small, fully open 95mm long

Pozzi Abdominal Retractors

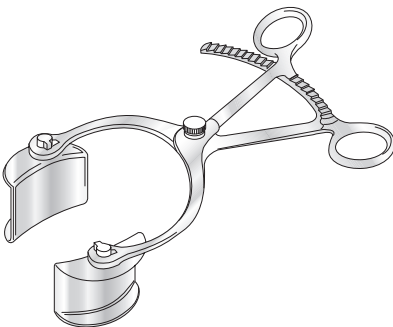

Code	Description
SC-GI/370	Swivel blades: 38 x 60mm, bivalve, 254mm long

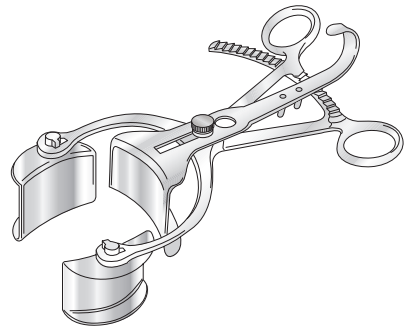

Code	Description
SC-GI/371	Swivel blades: 38 x 59mm, trivalve, 203mm long

Bowlby Dilator

Curved

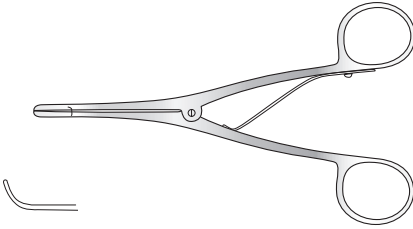

Code	Description
SC-GI/495	145mm long

Travers Retractor

Self retaining with internal rack, 210mm long

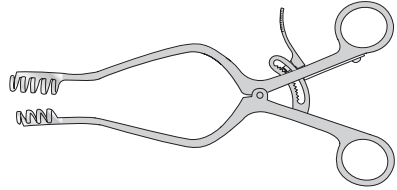

Code	Description
SC-GI/323	4 x 5 teeth, 95mm fully open

Irwin Retractor

Self retaining, with cam rack, 4 x 4 teeth

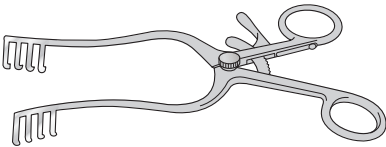

Code	Description
SC-GI/324	178mm long

West Retractor

Self retaining, 140mm long

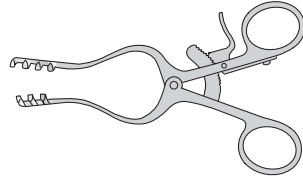

Code	Description
SC-GI/326	3 x 4 teeth, 60mm fully open
SC-GI/326cr	3 x 4 teeth, 60mm fully open, with cam rack

Norfolk and Norwich Retractor

4 x 5 teeth 50mm blades x 223mm long

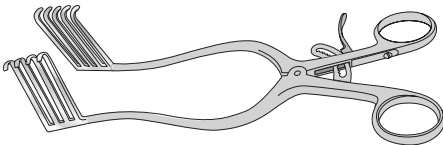

Code	Description
SC-GI/325	Standard rack

Weitlander Retractor

3-4 teeth

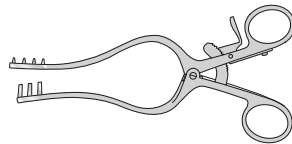

135mm long

Code	Description
SC-GI/496	Blunt
SC-GI/496a	Sharp
SC-GI/496b	Sharp, 2-3 teeth
SC-GI/496c	Blunt, 2-3 teeth

165mm long

Code	Description
SC-GI/497	Blunt
SC-GI/497a	Sharp

Retractors

Kocher Retractor

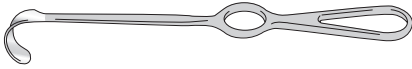

230mm long

Code	Description
SC-GI/378	36 x 20mm blade

250mm long

Code	Description
SC-GI/378a	67 x 25mm blade
SC-GI/378b	80 x 42mm blade
SC-GI/378c	80 x 50mm blade
SC-GI/378d	80 x 60mm blade

Kocher Langenbeck Retractor

215mm long



Code	Description
SC-GI/336sp	25 x 6mm blade
SC-GI/379a	35 x 8mm blade
SC-GI/379b	35 x 11mm blade
SC-GI/379c	35 x 15mm blade
SC-GI/357sp	41 x 11mm blade

Code	Description
SC-THO/cutsp015	55 x 11mm blade
SC-GI/379d	70 x 15mm blade
SC-GI/379e	80 x 12mm blade
SC-GI/379f	80 x 16mm blade

Langenbeck Retractor

Single ended



Code	Description
SC-GI/336	Blade 22mm x 6mm
SC-GI/337	Blade 45mm x 13mm
SC-GI/337a	Blade 65mm x 13mm
SC-GI/338a	Blade 75mm x 25mm
SC-GI/338a1	Blade 65mm x 25mm

Landon Retractor



Code	Description
SC-GI/494	230mm



Canny Ryall Navy Retractor

Double-ended, with one single hook blade 5mm wide, and one fenestrated blade

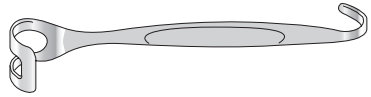

Code	Description
SC-GI/343	Fenestrated blade 16mm wide, 190mm long
SC-GI/343a	Fenestrated blade 19mm wide, 190mm long
SC-GI/343b	Fenestrated blade 25mm wide, 220mm long
SC-GI/343c	Fenestrated blade 30mm wide, 220mm long

Canny Ryall Army Retractor

Double prong, 13mm wide, 165mm long



Code	Description
SC-GI/342	Large, 19mm wide
SC-GI/342a	Small, 11mm wide



Czerny Retractor

Double ended

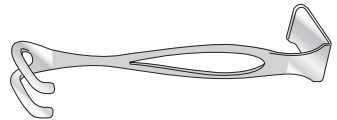

Code	Description
SC-GI/341	171mm long

Lane Retractor

Double ended blade, 229mm long

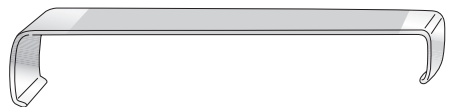

Code	Description
SC-GI/339	13mm x 19mm wide
SC-GI/340	25mm x 32mm wide

Morris Retractor

Single blade, 229mm long

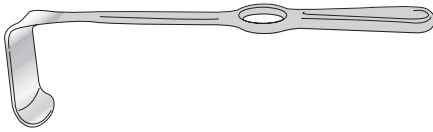

Code	Description
SC-GI/330	38 x 51mm
SC-GI/331	51 x 51mm
SC-GI/332	64 x 51mm

Morris Retractor

Double ended, 216mm long

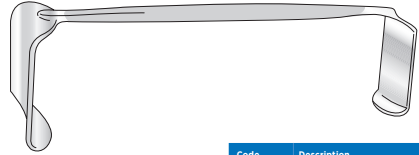

Code	Description
SC-GI/327	32 x 51mm and 38 x 51mm
SC-GI/328	44 x 51mm and 51 x 51mm
SC-GI/329	64 x 51mm and 38 x 51mm

Moynihan Retractor

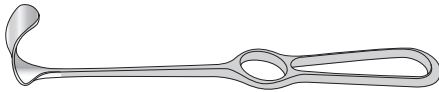

Code	Description
SC-GI/462	Single ended, blade 13 x 22mm, 215mm long

Deaver Abdominal Retractors



Code	Description
SC-GI/306	Set of 5, 315mm overall length
SC-GI/307	25mm wide
SC-GI/308	25mm wide
SC-GI/309	38mm wide
SC-GI/310	51mm wide
SC-GI/311	76mm wide

Elliot (Modified Deaver) Retractor



Code	Description
SC-GI/308M	With flat handle

Dyball and Lock Retractor

For liver

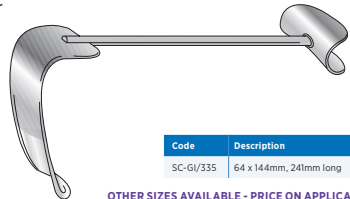

Code	Description
SC-GI/335	64 x 144mm, 241mm long

OTHER SIZES AVAILABLE - PRICE ON APPLICATION

Deaver Abdominal Retractors

With round handles

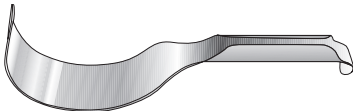

Code	Description
SC-GI/312	Set of 5, 305mm overall length
SC-GI/313	25mm wide
SC-GI/314	25mm wide
SC-GI/315	38mm wide
SC-GI/316	51mm wide
SC-GI/317	76mm wide

Kelly Retractor Blade

267mm long

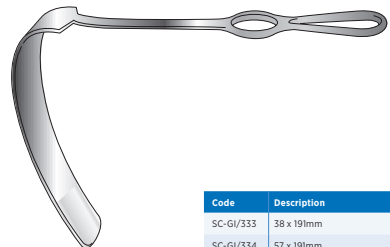

Code	Description
SC-GI/333	38 x 191mm
SC-GI/334	57 x 191mm

Retractors

Durham Retractor

With fenestrated blade, 216mm long

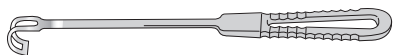

Code	Description
SC-GI/300	10mm wide
SC-GI/301	14mm wide
SC-GI/302	20mm wide

Ballance (Volkman) Retractor

203mm long

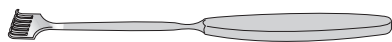

Sharp

Code	Description
SC-GI/463	1 prong
SC-GI/463a	2 prong
SC-GI/463b	3 prong
SC-GI/463c	4 prong
SC-GI/463d	6 prong

Blunt

Code	Description
SC-GI/463e	1 prong
SC-GI/463f	2 prong
SC-GI/463g	3 prong
SC-GI/463h	4 prong
SC-GI/463i	6 prong

Volkman Retractor



Code	Description
SC-OR/400	Sharp, 220mm long
SC-OR/400a	Blunt, 220mm long
SC-OR/400b	Sharp, 245mm long

Kilner Retractor

Double ended, cat's paw



Code	Description
SC-PL/056	152mm long

Kocher Retractor



Code	Description
SC-OR/N036c	Sharp, 205mm long
SC-OR/N036	Sharp, 220mm long
SC-OR/N036b	Blunt, 220mm long

Senn-Miller Retractor

170mm long



Code
SC-SH/5881

Single Hook Retractor

Sharp



Code	Description
SC-GI/SH5671	152mm long
SC-PL/065b	Half size, fine

Gillies Skin Hook

Solid handle, 190mm long



Code	Description
SC-PL/065a	Standard, fine
SC-PL/065b	Half size, fine

Dissectors and Probes

MacDonald Dissector Double Ended



Code	Description
SC-GI/285	191mm long

Probe, Sinus Silver



Code	Description
SC-GI/464	152mm long

Brodie Director Probe Ended, Silver Plated



Code	Description
SC-GI/286	165mm long

Probe, Fish Tail Silver Plated



Code	Description
SC-GI/293	127mm long
SC-GI/294	152mm long
SC-GI/295	203mm long
SC-GI/296	254mm long

Watson Cheyne Dissector

Fine, double-ended, with probe end



Code	Description
SC-GI/287	127mm long
SC-GI/288	191mm long
SC-GI/288a	230mm long
SC-GI/288b	255mm long

Jobson Horne Probe Dressing (Aural)

With one flat tapered end, serrated edge and one small ring end, stainless steel



Code	Description
SC-GI/297	140mm long
SC-GI/298	178mm long

Probe, Malleable Silver Plated



Code	Description
SC-GI/289a	127mm long
SC-GI/289	152mm long
SC-GI/290	178mm long
SC-GI/291	203mm long
SC-GI/292	255mm long
SC-GI/292a	305mm long

Bookwalter® Retractor Kit III

A table-fixed retractor system designed by surgeons to efficiently and reliably hold surgical instruments in place during surgery while allowing greater visibility.

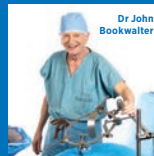

Kit includes Bookwalter® Kit:
Table Post and Coupling, Horizontal Flex Bar, Segmented Rings, Tilt Ratchet Mechanism, Kelly Retractors, Blades and Ratchets

Contact us for full details at info@surgicalholdings.co.uk

Miscellaneous

Aneurysm Needle

Small, for infusions



Code	Description
SC-GI/472a	146mm long

Syme Aneurysm Needle



Code	Description
SC-GI/473	165mm long

Ring Cutter

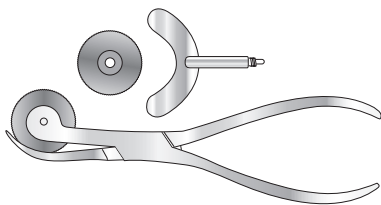

Code	Description
SC-GI/452	Circular saw blade, 165mm long
SC-GI/452a	Spare blade

Mayo Instrument Pin

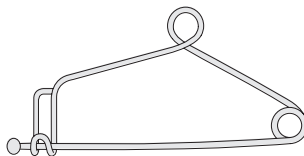

Code	Description
SC-GI/355	102mm long
SC-GI/356	152mm long

Baron Scalpel Handle

130mm long



Code	Description
SC-PM/003	No 3
SC-PM/004	No 4

Scalpel Handle

127mm long



Code	Description
SC-PM/007	No 3
SC-PM/008	No 4
SC-PM/008a	No 4 L
SC-PM/001a	No 7

Endoscope Re-fibre

Surgical Holdings manufacture their own fibre bundles in house. We cover small and larger diameter scopes and only use high quality German fibre optic material and stainless steel tubing.

- Quality components, globally sourced:
- ✓ Medical grade stainless steel tubing
 - ✓ German engineered new glass fibre
 - ✓ New fibre cone as standard
 - ✓ New solderable sapphire distal window
 - ✓ New light post colour ring
 - ✓ New objective in 95% of cases
 - ✓ Replacement 'O' ring to prevent leakage



After repair



Before repair

Contact us with your requirements
info@surgicalholdings.co.uk

Kidney Dish

Stainless steel

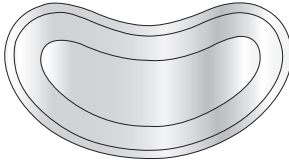

Code	Description
SC-GI/380	152mm
SC-GI/381	203mm
SC-GI/382	254mm
SC-GI/383	305mm

Lotion Bowl

Without lid, stainless steel

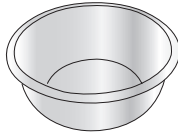

Code	Description
SC-GI/384	102mm
SC-GI/385	152mm
SC-GI/386	203mm
SC-GI/387	254mm
SC-GI/388	305mm

Instrument Tray

Stainless steel

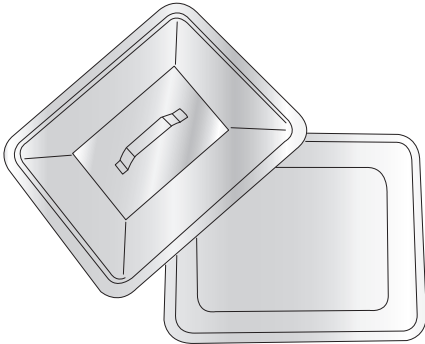

Code	Description
SC-GI/389	254 x 203 x 50mm
SC-GI/390	Lid only for 254 x 203 x 50mm
SC-GI/391	305 x 254 x 50mm
SC-GI/392	Lid only for 305 x 254 x 50mm
SC-GI/393	356 x 305 x 50mm
SC-GI/394	Lid only for 356 x 305 x 50mm

Cheate Jar

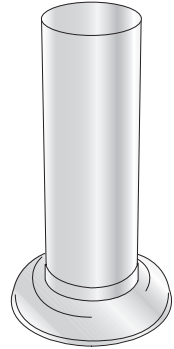

Code	Description
SC-GI/397	Stainless steel, 203mm x 50mm

Measuring Jug



Code	Description
SC-GI/395	1 litre capacity

Petri Dish



Code	Description
SC-SH/002149	100mm, stainless steel, with lid

Gallipot

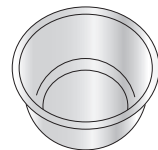

Code	Description
SC-GI/396	Stainless steel, 63mm

Silicone Matting

Medical grade for storage, sterilisation and transportation of instruments.

Cushion, protect, and organise delicate surgical instruments during storage, transportation, and sterilisation. Perforations allow for ventilation during the sterilisation process. The silicone mat can be cut to fit any size container.

 SILICONE MATTING AVAILABLE FOR ALL BASKETS - PLEASE ASK FOR PRICE

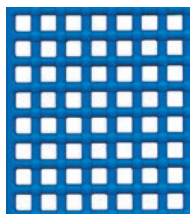

502mm long x 242mm wide
7mm holes, 10mm between holes

Code
BES/1004M

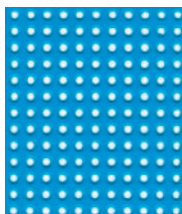

515mm long x 240mm wide
3mm holes, 6mm between holes

Code
BES/1001M

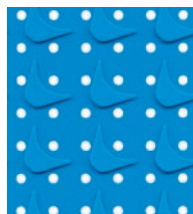

570mm long x 550mm wide
4mm holes, 13mm between holes

Code
BES/1002M

Sterilising Baskets

DIN Basket

Wire mesh base with perforated sides and two carrying handles

Code	Description	Code	Description
SC-GI/CO006	230 x 130 x 60mm	SC-GI/CO013	480 x 250 x 70mm
SC-GI/CO007	240 x 130 x 50mm	SC-GI/CO016	480 x 400 x 60mm
SC-GI/CO008	240 x 130 x 60mm	SC-GI/CO017	480 x 480 x 50mm
SC-GI/CO009	240 x 250 x 50mm	SC-GI/CO018	480 x 480 x 60mm
SC-GI/CO010	240 x 250 x 60mm	SC-GI/CO019	500 x 300 x 50mm
SC-GI/CO014	300 x 300 x 50mm	SC-GI/CO020	550 x 430 x 50mm
SC-GI/CO015	350 x 350 x 60mm	SC-GI/CO021	600 x 300 x 60mm
SC-GI/CO011	480 x 250 x 50mm		
SC-GI/CO012	480 x 250 x 60mm		



DIN Basket

Wire mesh basket with two carrying handles

Code	Description	Code	Description
SC-GI/CO022	240 x 250 x 50mm	SC-GI/CO026	480 x 250 x 60mm
SC-GI/CO023	240 x 250 x 60mm	SC-GI/CO027	480 x 250 x 70mm
SC-GI/CO024	240 x 250 x 70mm	SC-GI/CO028	480 x 250 x 100mm
SC-GI/CO031	300 x 300 x 60mm	SC-GI/CO029	480 x 480 x 50mm
SC-GI/CO025	480 x 250 x 50mm	SC-GI/CO030	480 x 480 x 70mm

DIN Basket Lids

For perforated and wire mesh baskets

Code	Description
SC-GI/CO032	240 x 250mm
SC-GI/CO033	300 x 300mm
SC-GI/CO034	480 x 250mm
SC-GI/CO035	480 x 480mm

Did you know...

Organising and fixing instruments in place can aid the cleaning process.

Help keep your instruments in good condition for longer with our baskets and trays. Available in custom sizes, to suit your requirements perfectly.

info@surgicalholdings.co.uk

ENT Basket

Wire mesh base with perforated sides and two carrying handles, supplied with lid

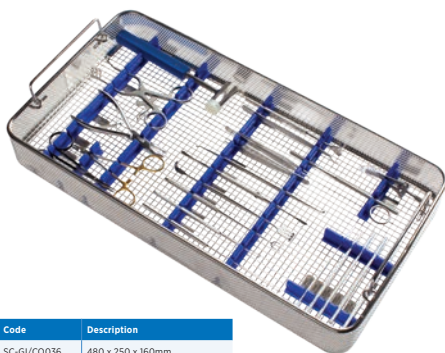

Code	Description
SC-GI/CO036	480 x 250 x 160mm
SC-GI/CO037	Fixing clamps

Sieve

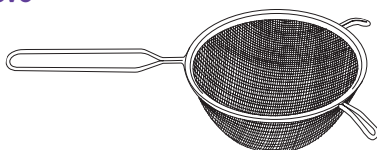

Code	Description
SC-GI/5071	203mm x 50mm ø

Arthroscope Basket

Wire mesh base with two fixing clamps

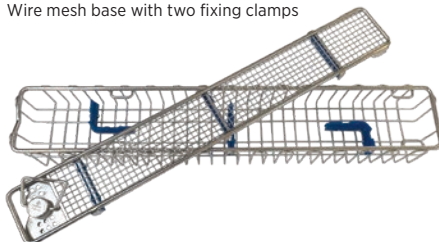

Code	Description
SC-GI/CO001	290 x 80 x 52mm

Endoscope Basket

With small lens basket

Code	Description
SC-GI/CO002	6400 x 150 x 77mm

Wire mesh base with two fixing clamps

Code	Description
SC-GI/CO003	S - 460 x 80 x 52mm
SC-GI/CO004	D - 480 x 80 x 52mm
SC-GI/CO005	D - 680 x 80 x 52mm

Fine Mesh Basket



With hinged take off / lockable lid

Code	Description
SC-GI/CO041	120 x 155 x 40mm
SC-GI/CO044	120 x 155 x 50mm
SC-GI/CO042	235 x 155 x 40mm
SC-GI/CO045	235 x 155 x 50mm
SC-GI/CO043	375 x 260 x 40mm

With separate lid

Code	Description
SC-GI/CO038	120 x 155 x 40mm
SC-GI/CO039	235 x 155 x 40mm
SC-GI/CO040	375 x 260 x 40mm

Symmetry Surgical Quadlock Containers



Surgical Holdings offer the unique Quadlock container. The Patented design offers 4 locks, as opposed to the traditional 2, to ensure extra security and peace of mind.

Contact us for full spec and to order
info@surgicalholdings.co.uk



WE ALSO MAKE CUSTOM BASKETS AND TRAYS,
CONTACT US TO DISCUSS YOUR REQUIREMENTS

Optical Fibre Cables

Our optical fibre cables are compatible with all major scopes and illuminators. Every light lead is high temperature xenon compatible, rated to the highest level of thermal resistance and tested to ensure the highest light output possible.

Choice of 10 colours for easy identification

Choice of lengths and sheathing types

Free on-site light lead testing
We'll come and go through your lead stock to ensure your leads are fit for use

Reinforced for longer life

How to order

Select an option from each of the following steps to create your part number.

Part number = _____

Step 1 Step 2 Step 3 Step 4 Step 5 Step 6 Step 7

Example: 474810180FRGY is a Storz Proximal, Storz Distal, 4.8mm Bundle, 254mm Length, Fully Reinforced Sheathing in Grey

Step 1: Proximal

All end tips are stainless steel

ACMI

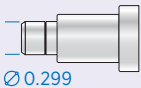

1

Wolf/Dyonics

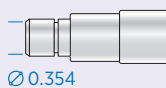

2

Long Wolf



L2

Olympus/ACMI

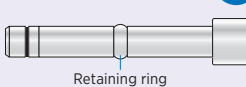

3

Storz



4

Pilling

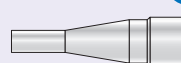

5

Universal

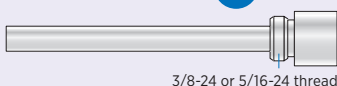

U

Step 2: Distal

All end tips are stainless steel

Wolf Snap On

6

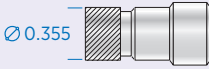

Storz

7

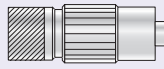

ACMI Snap-On

8

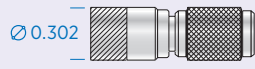

Olympus

9

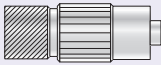

Wolf Clip-On

10



Pilling

11

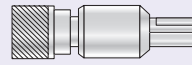

ACMI Clip-On

12



Mini Olympus

13



2.8 mm & 4.25 mm only

Universal

U

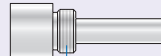

3/8-24 or 5/16-24 thread

Step 3: Bundle Size

Place gauge on bundle to determine diameter

2.2mm 22



2.8mm 28



Mini Olympus only

3.0mm 30



3.8mm 38



4.25mm 425



Mini Olympus only

4.8mm 48



Step 4: Length

6ft

6

8ft

8

10ft

10

Call us for custom lengths

Step 5: Connector Angle

180°

180

45°

45

90°

90

Step 6: Sheathing Type

Non-reinforced

0

6" Reinforced*

6

Fully Reinforced*

FR

*Reinforced options are not available with clear sheathing

Step 7: Sheathing Colour

Black



BK

Blue



BL

Clear



CL

Green



GR

Gray



GY

Red



RD

Pink



PK

White



WH

4.8mm only

Yellow



YL

Index

A

Adson Artery Forceps	14
Adsons Dissecting Forceps	18
Allis Tissue Forceps	20
Aneurysm Needle	44
Arthroscope Basket	47

B

Babcock Tissue Forceps	20
Baby Metzenbaum Scissors	26
Backhaus Towel Clip	34
Balfour Abdominal Retractor	35
Ball and Socket Towel Forceps	34
Ballance (Volkman) Retractor	42
Baron Scalpel Handle	44
Berkeley Abdominal Retractor	35
Berry Needle Holder/Wire Twister	31
Blalock Bulldog Clamp	17
Block End Dissecting Forceps	18
Bonney Dissecting Forceps	18
Bowlby Dilator	39
Boyd Scissors	28
Brodie Director Probe Ended, Silver Plated	43
Bruce Clarke Needle Holder	29

C

“Careless” Scissors	25
Cairns Artery Forceps	14
Canny Ryall Army Retractor	40
Canny Ryall Navy Retractor	40
Carmalt Angiotribe Forceps	16
Charnley-McIndoe Dissecting Forceps	18
Cheatle Jar	45
Cheatle Sterilizer Forceps	22

Childe Approximating Forceps	23
Collin Retractor	38
Crile Artery Forceps	14
Crile-Wood Needle Holder	29, 31
Cushing Artery Forceps	14
Czerny Retractor	40

D

Dandy Artery Forceps	16
Deaver Abdominal Retractors	41
DeBakey Atraumatic Dissecting Forceps	18
DeBakey Needle Holder	32
Derf Needle Holder	31
Dieffenbach Bulldog Clamp	17
DIN Basket Lids	46
DIN Basket	46
Dissecting Forceps	18
Dressing Scissors	24, 26, 27, 28
Dressing Scissors, Left-Handed	24
Dunhill Artery Forceps	14
Dunhill Dissecting Forceps	18
Durham Retractor	42
Duval Tissue Forceps	20
Dyball and Lock Retractor	41

E

Elliot (Modified Deaver) Retractor	41
ENT Basket	47

F

Fergusson Scissors	24
Fine Mesh Basket	47
Finochietto Needle Holder	31
Foerster Sponge Holding Forceps	22

Foster Gillies Scissor/Needle Holder	33		
Fraser Kelly Artery Forceps Curved	15		
Fredrick Coole Dissecting Forceps	18		
G			
Gallipot	45		
Gelpi Retractor	38		
Gillies Dissecting Forceps	19		
Gillies Scissor/Needle Holder	33		
Gillies Skin Hook	42		
Goligher Retractor	35		
Gossett Abdominal Retractor	38		
Guys Gallabin Suture-Holding Forceps	21		
H			
Halsey Needle Holder	31		
Halstead Mosquito Forceps	15		
Harrison Bowl Steriliser Forceps	22		
Heath Stitch Scissors	25		
Heiss Artery Forceps	15		
Hunter Splinter Forceps	23		
I			
Instrument Tray	45		
Iris Scissors	28		
Irwin Retractor	39		
J			
Jackson Burrows Dissecting Forceps	19		
Jean Dissecting Forceps	19		
Jobson Horne Probe Dressing (Aural)	43		
Joll Thyroid Retractor	38		
Jones Towel Clip	34		
K			
Kelly Artery Forceps	15		
Kelly Retractor Blade	41		
Kidney Dish	45		
Kilner Dissecting Scissors	24		
Kilner Needle Holder	29, 31		
Kilner Retractor	42		
Kocher Artery Forceps	15		
Kocher Langenbeck Retractor	40		
Kocher Retractor	40, 42		
L			
Landon Retractor	40		
Lane Retractor	40		
Lane Tissue Forceps	20		
Lanes Dissecting Forceps	19		
Langenbeck Retractor	40		
Lawrence Needle Holder	29		
Lawson Tait Artery Forcep	14		
Ligature Scissors	26		
Ligature Stitch Scissors	24		
Lister Bandage Scissors	25		
Lister Sinus Forceps	22		
Littler Dissecting Scissors	24		
Littlewood Tissue Forceps	20		
Lotion Bowl	45		
M			
MacDonald Dissector Double Ended	43		
MacPhail Needle Holder	29		
Masing Needle Holder	32		
Mathieu Needle Holder	30		
Mayo Dressing Scissors	26		
Mayo Harrington Scissors	27		

Index

Mayo Instrument Pin	44	Pozzi Abdominal Retractors	38
Mayo Needle Holder	30	Probe, Fish Tail Silver Plated	43
Mayo Scissors	24, 27, 28	Probe, Malleable Silver Plated	43
Mayo-Harrington Dressing Scissors	26	Probe, Sinus Silver	43
Mayo-Hegar Needle Holder	32		
McIndoe Dissecting Forceps	19	R	
McIndoe Modified Dissecting Forceps	19	Ramplcy Sponge Holding Forceps	22
McIndoe Scissors	25	Ring Cutter	44
Measuring Jug	45	Roberts Artery Forceps	16
Metzenbaum Dissecting Scissors	27, 28	Robins Anchoring Forceps	23
Metzenbaum Scissors	24, 26	Rochester-Mayo Needle Holder	30
Michel Clip Extracting Forceps	23	Rochester-Pean Artery Forceps	16
Michel Forceps	23	Russian Dissecting Forceps	21
Michel Skin Holding Forceps	23	Rutherford Morrison Tissue Forceps	20
Miles Retractor	35	Ryder Needle Holder	32
Morris Retractor	41		
Moynihan Retractor	41	S	
Moynihan Artery Forceps	16	Sarot Needle Holder	32
Moynihan Towel Clip	34	Scalpel Handle	44
		Senn-Miller Retractor	42
N		Shardles Towel Clip	34
Naughton Morgan Needle Holder	30	Shaw Tissue Forceps	21
Needle Holder	29	Sieve	47
Nievert Needle Holder	32	Silicone Matting	46
Norfolk and Norwich Retractor	39	Single Hook Retractor	42
		Spencer Wells Artery Forceps	16
O		Spring Bag Clip	34
Olsen-Hegar Scissor/Needle Holder	33	Spring Clip	34
Optical Fibre Cables	48-49	Sterilising Baskets	46-47
		Stevens Tenotomy Scissors	28
P		Strabismus Scissors	28
Paynes Suture Scissors	24	Syme Aneurysm Needle	44
Petri Dish	45		

T

Thomas Strabismus Scissors	25
Travers Retractor	39
Treves Dissecting Forceps	19
Tubing Scissors	25
Turner Warwick Blades	36-37
Turner Warwick Needleholder with Tungsten Carbide Jaws	36
Turner Warwick Universal Self Retaining Retractor	36

U

Utility Scissors	25
------------------	----

V

Volkman Retractor	42
-------------------	----

W

Watson Cheyne Dissector	43
Waugh Dissecting Forceps	19
Weitlander Retractor	39
West Retractor	39

Our Manufacturing Partners

We're proud to be approved UK suppliers of the top global brands in surgical instruments, giving us access to thousands of both big-name and some of the more obscure, but nevertheless important, instruments.











+ Our strong relationships with these businesses go back many years. This means we can provide you with quality instruments from the brands you know, at very competitive prices.



symmetry™
BOOKWALTER™



Instrument Sales

-  Surgical Holdings Instruments
-  Symmetry Surgical
-  Hermann Laparoscopic
-  Bissinger Bipolar
-  Light Leads
-  DIN Baskets & Containers
-  Sterile Packed K-Wires
-  Custom-made Instruments

Refurbish & Repair

-  Surgical Instruments
-  Laparoscopic Instrumentation
-  Electrosurgery Devices
-  Rigid Endoscopes



Surgical Holdings Parkside Centre, Temple Farm Ind. Est., Southend-on-Sea, Essex, SS2 5SJ
E. info@surgicalholdings.co.uk T. +44 (0)1702 602050 F. +44 (0)1702 460006
surgicalholdings.co.uk

