

Waters™

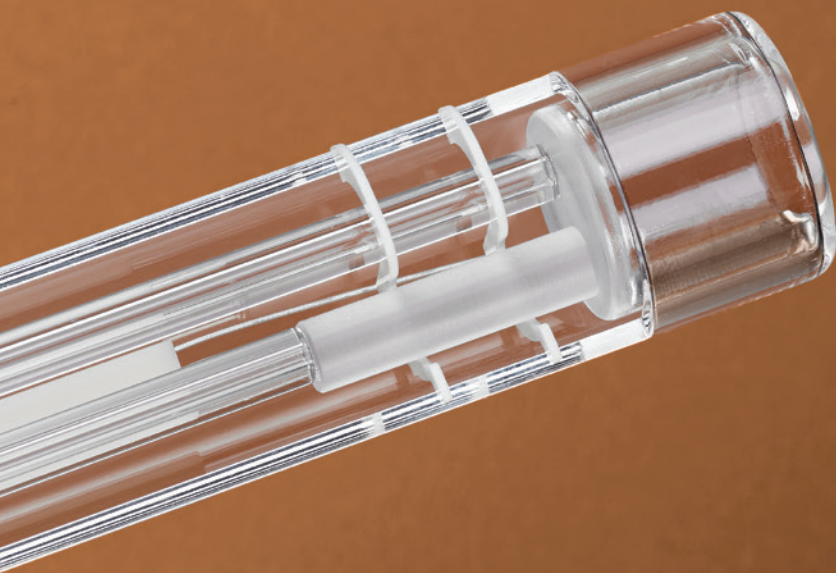

DILATOMETRY  
PUSH-ROD AND OPTICAL

## HIGH PERFORMANCE DILATOMETERS

A dilatometer is a precision instrument for the measurement of dimensional changes in material as a function of temperature. Dilatometry can be used to test a wide range of material including traditional and advanced ceramics, glasses, metals, and polymers. It provides measurements of a wide variety of properties including linear thermal expansion, coefficient of thermal expansion, sintering temperature, shrinkage steps, phase transitions, density change, softening point and decomposition temperature, anisotropic behavior, and glass transition temperature.

No single dilatometer can effectively and precisely meet the testing requirements of such a wide range of materials and material property measurements. Only TA Instruments offers a complete line of horizontal, vertical, and optical dilatometers and can provide the right instrument to match your needs no matter the application.

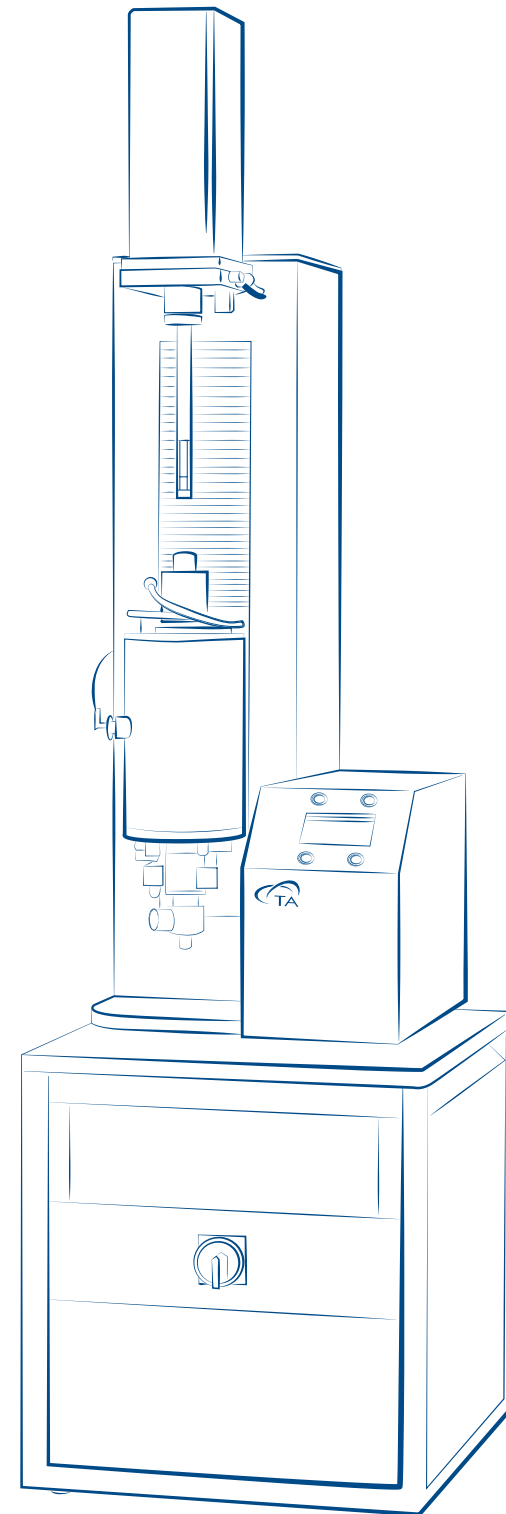
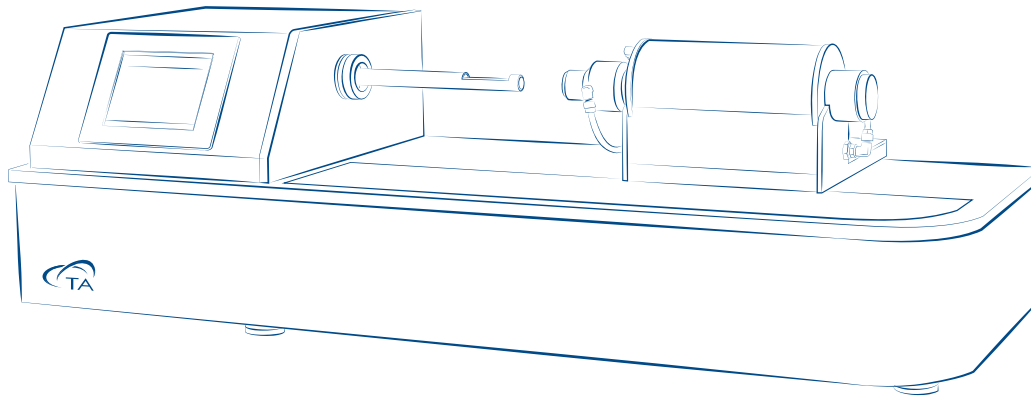

# DILATOMETRY

## and the Measurement of DIMENSIONAL CHANGES

In a dilatometry experiment, a sample is placed into a holder with one end brought into contact with a push-rod. Alternatively, for a non-contact measurement, the sample is framed by optical CCD sensors. The sample and holder are then enclosed within a furnace where the sample is subjected to a prescribed temperature program of heating, cooling, or isothermal conditions. During the experiment, the linear dimensional change (expansion or contraction) of the sample is measured by a highly accurate displacement sensing system.

The linear dimension change,  $\Delta L$ , that occurs under a specific temperature change,  $\Delta T$ , is called the linear thermal expansion,  $d\%$ . It is simply expressed as the ratio of  $\Delta L$  to the initial length,  $L_0$ . The fractional linear change per degree change in temperature is called the Coefficient of Linear Thermal Expansion and is denoted in the abbreviated form of CTE or by the Greek letter  $\alpha$ .

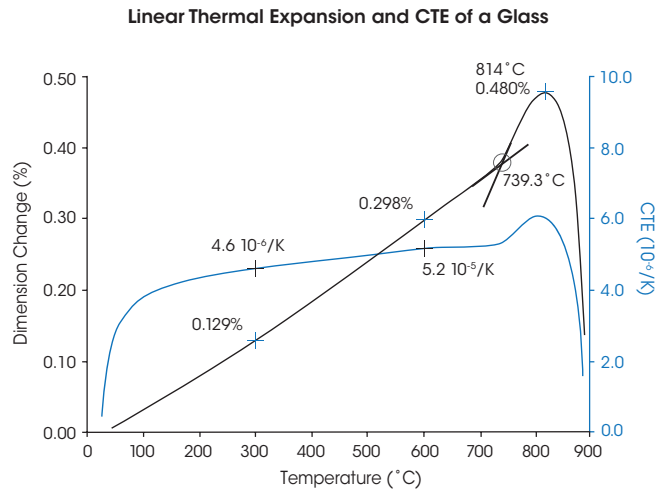
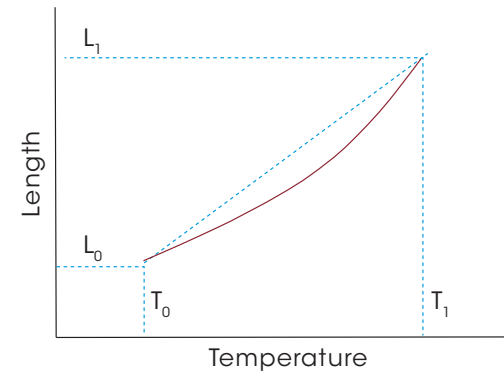
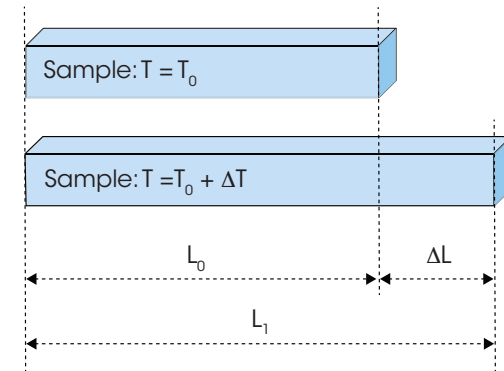

$$d\% = \frac{\Delta L}{L_0} = \frac{L_1 - L_0}{L_0}$$

$$\text{CTE} = \alpha = \frac{\Delta L}{L_0 \Delta T} = \frac{L_1 - L_0}{L_0 (T_1 - T_0)}$$

# Understanding DILATOMETRY MEASUREMENT TECHNOLOGIES: PUSH-ROD vs. OPTICAL

All materials and applications requiring exacting measurements of dimension change are not created equal. Measurement accuracy can be affected by factors such as how soft or rigid a sample is and how this physical state may change, the magnitude of the dimension change, the temperature range or rate required, or that the sample is irregularly shaped and difficult to load in a conventional way. For these reasons, it is critical to understand both the choices in measurement techniques and technologies as well as the advantages of these techniques for making the right choice for the application at hand. In dilatometry, technology comparisons are often made between horizontal and vertical push-rod designs, which are often positioned as “one-size-fits-all” solutions. **Only** TA Instruments can offer a complete line of **push-rod** and **optical dilatometers**. The table and figures below provide a comparison of these technologies to help ensure the proper instrument selection to meet specific needs of any material and/or application.

Parameter	Push-rod	Optical
Operating modes	Dilatometry	Dilatometry, fleximetry, heating microscopy
1 Displacement sensor technology resolution	Optical encoder, or LVDT max. 1 nm	Optical bench with HD cameras, or CCD sensors max 50 nm
2 Measuring system	Push-rod in mechanical contact with the sample	Light beam emitted by LED for contact-less measurement
3 Sample Dimension Physical state	0.1 to 50 mm rigid to moderately soft	0.3 to 80 mm rigid to molten
4 Temperature range	-150°C to 2300°C (*)	-150°C to 1650°C (*)

(\*) Possible with different furnaces

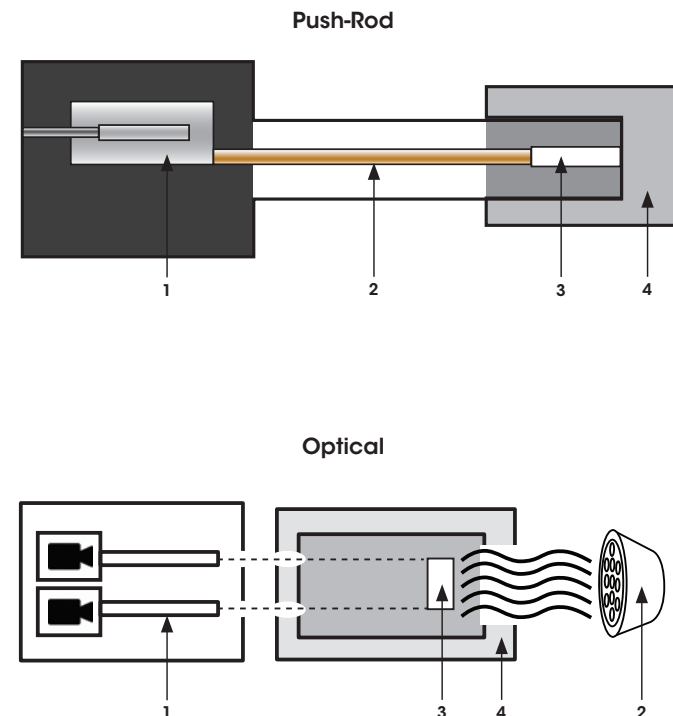

# Push-rod Dilatometry | True Differential™ Technology

The main components of a push-rod dilatometer are a measuring head consisting of a displacement sensor and force controller to apply load to the sample, a measuring system consisting of a sample holding tube and push-rod connected to the displacement sensor, and a movable furnace. The sample is sandwiched between the end of the measuring system and the push-rod. As the temperature changes during an experiment, the sample and the measuring system expand and contract together. The measuring head records a signal that is the sum of all these changes. Single-sample, dual-sample and True Differential™ dilatometers incorporate varied measuring head designs using different approaches for calibrating and correcting displacement contributions of the measuring system to the true sample. The most accurate results are delivered by the **True Differential™ design offered ONLY by TA Instruments.**

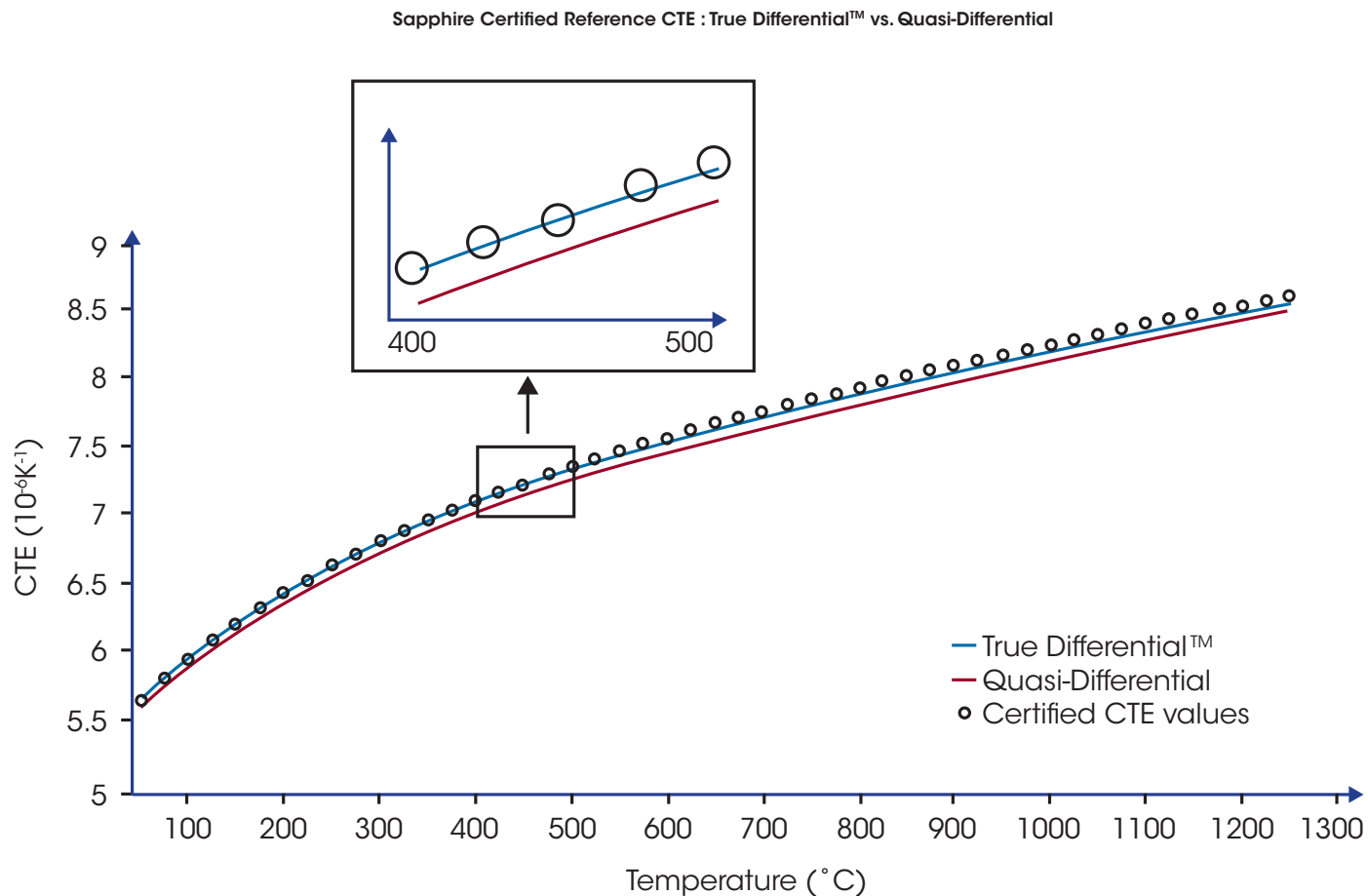

# Unique True Differential™ Technology Provides **UNMATCHED PRECISION** and **ACCURACY** for **THERMAL EXPANSION MEASUREMENTS**

## True Differential™ vs. Quasi-Differential

In traditional single push-rod dilatometry, a reference standard of known thermal expansion is used as a calibrant to establish a baseline that is subsequently used to correct for measurement system effects when running samples. In the "differential" approach, a second push-rod is incorporated into the design, allowing the reference calibrant to be run simultaneously leading to improved precision and accuracy. There are two different approaches to differential dilatometry, referred to as "quasi-differential" and TA Instruments' unique True Differential™ design, shown schematically in the figures to the right. A brief review of the schematics and discussion of these designs reveals why the True Differential™ by TA is superior to the quasi-differential approach.

In the quasi-differential approach, a dual-sample dilatometer is used in this "quasi-differential" mode and software is used to subtract signals from two separate transducers. Although this approach improves accuracy over the single-sample mode measurement, the use of two separate displacement sensors introduces further variables and software algorithms are still required.

In the unique TA Instruments True Differential™ configuration, a single displacement transducer uses an innovative approach to provide improved accuracy over the quasi-differential approach. The core of the differential transducer is coupled to the reference specimen while the coil of the transducer is coupled to the sample. The result is the transducers frame of reference moves with system expansion, leaving only sample expansion to be measured, **resulting in increased accuracy, reduced reliance on system calibration, and increased temperature program flexibility.** The results in the figure to the left clearly show the improved accuracy of the True Differential™ measurements on a certified Sapphire standard.

TA Instruments Unique True Differential™

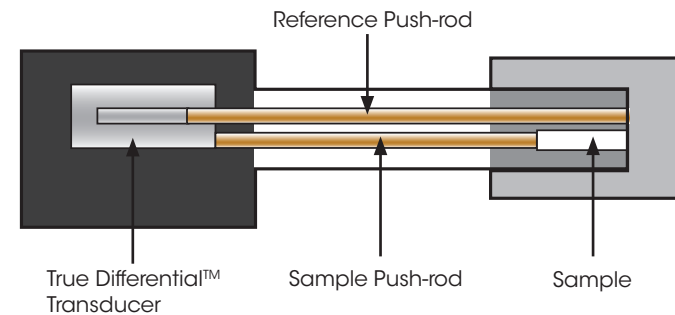

Dual-sample in Quasi-Differential mode

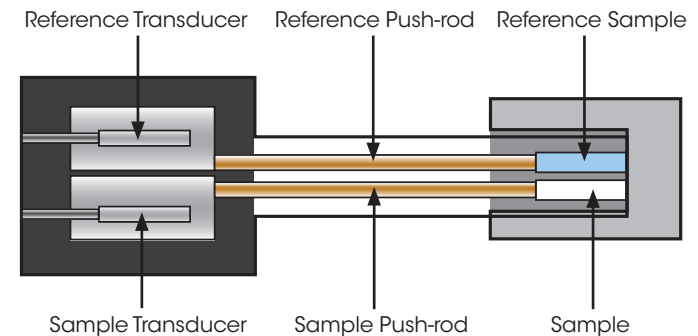

# HIGH RESOLUTION HORIZONTAL DILATOMETER | DIL 830 Series

The DIL 830 Series features an impressive array of unique technologies and capabilities that make it the ideal choice for any R&D laboratory in need of the most accurate measurements of dimensional properties of materials. The instruments includes exclusive True Differential™ technology, optical encoder displacement sensor, new fast-cool dynamic and motorized furnaces, measuring head housing with active thermal stabilization, touch screen display, and the new linear sample load motor. The result is the highest performing horizontal push-rod dilatometer available, regardless of the material or application.



# The World's **MOST ADVANCED** **HORIZONTAL PUSH-ROD** **DILATOMETER**

## Features and Benefits:

- Exclusive True Differential™ technology reduces reliance on system calibrations and provides industry leading CTE accuracy of  $0.01 \times 10^{-6} \text{ K}^{-1}$
- Dynamic fast-cool furnaces improve throughput by a factor of seven compared to any competitive design
- New optical encoder with a resolution of 1 nm detects the smallest dimensional changes and enables measurements of shorter samples without sacrificing  $\Delta L$  resolution
- Newly designed measuring head housing with active electrical thermal stabilization ensures unprecedented stability of the detection core
- Sample load delivered by magnetic motor with a linearity better than  $\pm 0.005 \text{ N}$  across the entire measuring range of 5,000  $\mu\text{m}$  ensures constant load regardless of changes in sample length
- Motorized furnace stage for convenient sample loading and unloading
- Integrated touch screen enhances usability with convenient access to instrument functions and real-time display of measurement parameters and test time
- Initial sample length automatically measured and recorded, eliminating potential for human error
- Available in two models with flexible sample configurations with maximum length of 25 mm and diameter of 6 mm or 12 mm (see specifications for details)
- Conforms to all major standard dilatometry test methods including: ASTM C372, ASTM E228, DIN 52328, ASTM C531, ASTM E831, DIN 53752, ASTM C824, DIN 51045, SEP 1680, ASTM D696, DIN 51909, SEP 1681

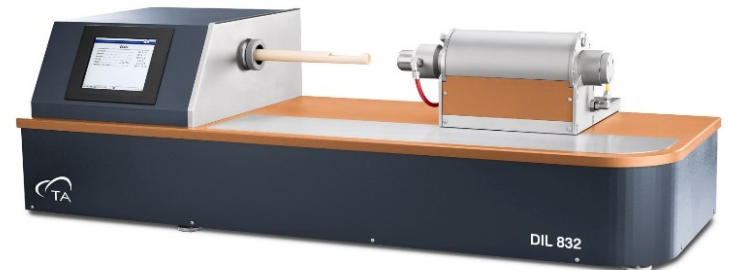

**DIL 832 True Differential™**  
**Horizontal High Resolution Dilatometer**



# ADVANCED VERTICAL DILATOMETER

## DIL 820 Series

DIL 820 Series dilatometers operate in a vertical orientation making them uniquely capable of conducting experiments simply not possible on a horizontal design. Some examples include applications where displacement from expansion or shrinkage is large such as Rate Controlled Sintering (RCS), higher temperature applications up to 2300°C, and testing of challenging materials such as powders. 820 Series models feature exclusive True Differential™ technology, optical encoder displacement sensor, new fast-cool dynamic and motorized furnaces, measuring head housing with active thermal stabilization, color display, and the new linear sample load motor. The result is the highest performing vertical push-rod dilatometer available for the most challenging measurements of dimension also available in a reactive-gas version for measurements in reducing forming-gas atmosphere.



# VERTICAL DESIGN for the Most CHALLENGING APPLICATIONS

## Features and Benefits:

- Exclusive True Differential™ technology reduces reliance on system calibrations and provides industry leading CTE accuracy of  $0.01 \times 10^{-6} \text{ K}^{-1}$
- Vertical orientation provides unique testing capabilities not possible on horizontal design, such as large frictionless displacement capabilities for precise and accurate sintering studies, and testing of challenging materials such as powders
- Vertical orientation prevents sagging of the measuring systems and furnace tubes at high temperatures, enabling testing to higher temperatures for longer periods of time
- Dynamic fast-cool furnaces with natural cooling times of less than one hour improves throughput by a factor of seven compared to any competitive design
- Housing design decouples the thermal bridge between the furnace and measuring head preventing the "chimney effect" for unprecedented temperature uniformity in a vertical design
- New optical encoder with a resolution of 1 nm detects even the smallest dimensional changes and enables measurements of shorter samples without sacrificing  $\Delta L$  resolution
- Six models with temperature ranges between  $-150^{\circ}\text{C}$  to  $2300^{\circ}\text{C}$
- Magnetic motor with industry-leading linearity of  $\pm 0.005 \text{ N}$  across the entire  $5000 \mu\text{m}$  measuring range allows testing of difficult, load-sensitive samples that are impossible to test on traditional horizontal push-rod instruments
- Small linear footprint frees up valuable lab bench space compared to horizontal models
- Conforms to all major standard test methods for dilatometry including: ASTM C372, ASTM E228, DIN 52328, ASTM C531, ASTM E831, DIN 53752, ASTM C824, DIN 51045, SEP 1680, ASTM D696, DIN 51909, SEP 1681



**DIL 822**  
True Differential™ Vertical  
Dilatometer



**DIL 821HT**  
High Temperature Vertical  
Dilatometer

# DIL 820 AND 830 SERIES | TECHNOLOGY

## **True Differential™ Design Delivers Ten Times Better CTE Accuracy**

True Differential™ technology, available on DIL 822 and DIL 832 models, delivers unparalleled performance right where it is most needed in dilatometry: CTE accuracy. With the industry leading value of  $0.01 \times 10^{-6} \text{ K}^{-1}$ , it provides the confidence in analysis scientists and engineers require for testing and evaluating today's high value and high-performance materials. Note: Refer to page 5 for a detailed explanation of the True Differential™ approach.

## **New Dynamic Furnaces Improve Throughput by a Factor of Seven**

The cooling time of furnaces leads to long downtimes between consecutive tests and has resulted in dilatometry being viewed as a time-consuming, low throughput technique. That is why TA is pleased to introduce the newly designed 800 Series furnaces featuring ballistic cool down times. Regardless of the maximum temperature of the test, these furnaces can cool to room temperature in under one hour, dramatically improving throughput and eliminating the need for the expense of duplicate furnaces.

## **Optical Encoder Delivers 1 nm Resolution**

The 820 and 830 series dilatometers include proven and reliable optical encoder technology providing a displacement resolution of 1 nm. This offers several advantages over traditional LVDT systems. As resolution is improved by a factor of ten, it enables testing of very small specimens or high-performance materials exhibiting extremely small dimensional changes.

## **New Motor Delivers Constant Contact Force**

The design of the new magnetic motor guarantees a sample load with a linearity of  $\pm 0.005 \text{ N}$  linearity over the entire  $5,000 \mu\text{m}$  displacement range. This ensures a constant contact between push-rod and sample regardless of the specimen's dimensional changes or the rate at which they occur. This is a key instrument capability for accurate sintering studies.

**TECHNOLOGY** that **DELIVERS** the  
**HIGHEST RESOLUTION**  
and **CTE ACCURACY**

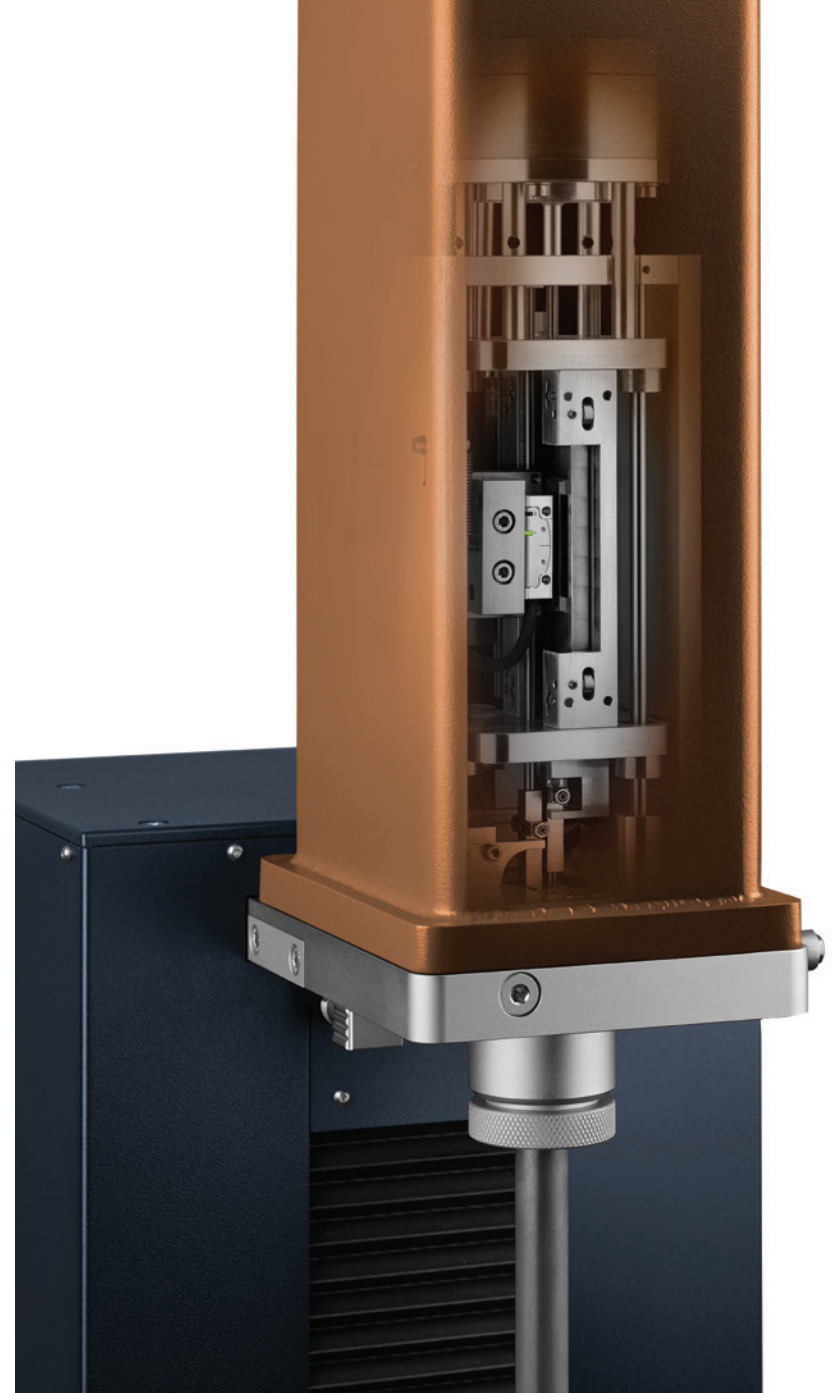

**DIL 820 Series Vertical Dilatometer:**  
Measuring Head with Optical Encoder and Magnetic Motor

## Optical Encoder Measures Nanoscale Dimensional Changes

The accurate measurement of very thin specimens of dimensionally stable materials, being those with very low CTE's, can be challenging for some dilatometers. The DIL 820 and 830 series incorporate optical encoders with a displacement resolution of 1 nm, making the accurate measurement of such materials possible. The upper right graph shows the results of a sample of Alumina of only 650  $\mu\text{m}$  thick measured on a DIL 830 series horizontal dilatometer from RT to 1200°C. It can be seen here that an expansion of only 2.26  $\mu\text{m}$  was easily measured using this optical encoder technology.

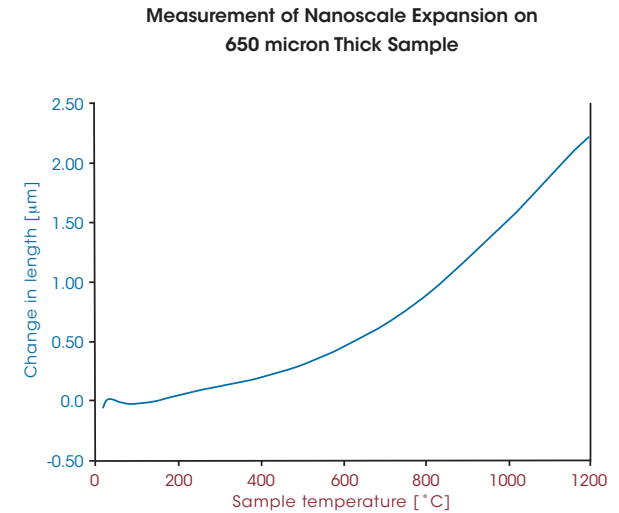

## Fast Dynamic Furnaces Improve Productivity by a Factor of 3

A major contributor of dilatometry testing times are the long hours it takes to cool down the furnace once the experiment ends. 820 and 830 Series dynamic furnaces feature hi-tech insulation materials and active cooling that dramatically reduces the idle, non-productive time between consecutive runs. The plot here on the right shows how in less than one hour from the end of a test at 1700°C it is possible to start another test without requiring a second furnace. The use of the same furnace greatly improves reproducibility and prevents the need to use multiple correction curves, a source of potential user-induced errors.

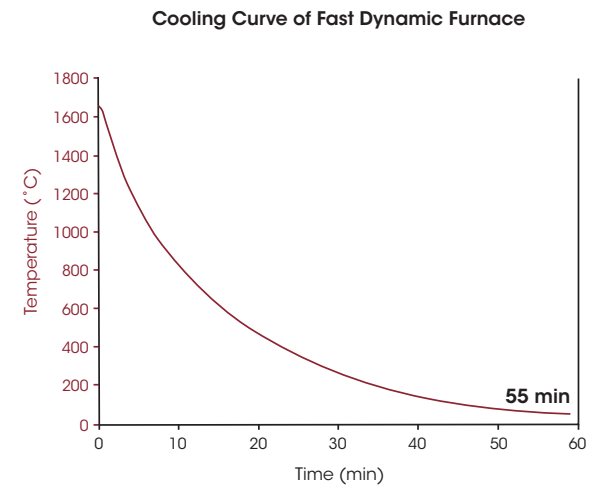

# DIL 820 AND 830 SERIES | SPECIFICATIONS

Parameter	821	822	831	832
<b>Design</b>	Single Sample Vertical Push-rod	True Differential™ Vertical Push-rod	Single Sample Horizontal Push-rod	True Differential™ Horizontal Push-rod
<b>Maximum Sample Length</b>	25 mm	25 mm	25 mm	25 mm
<b>Maximum Sample Diameter</b>	12 mm	5 mm	12 mm	5 mm
<b>Displacement System</b>	Optical encoder	Optical encoder	Optical encoder	Optical encoder
<b>Length (ΔL) Resolution</b>	1 nm	1 nm	1 nm	1 nm
<b>Measuring Range</b>	5 mm	5 mm	5 mm	5 mm
<b>CTE Accuracy</b>	0.03 10 <sup>-6</sup> K <sup>-1</sup>	0.01 10 <sup>-6</sup> K <sup>-1</sup>	0.03 10 <sup>-6</sup> K <sup>-1</sup>	0.01 10 <sup>-6</sup> K <sup>-1</sup>
<b>Sample Holders</b>	Fused Silica, Alumina or Graphite	Fused Silica, Alumina or Graphite	Fused Silica or Alumina	Fused Silica or Alumina
<b>Temperature Range</b>	-160 °C to 2300 °C (*)	-160 °C to 2300 °C (*)	-160 °C to 1700 °C (*)	-160 °C to 1700 °C (*)
<b>Maximum Heating Rate</b>	100 °C/min (*)	100 °C/min (*)	100 °C/min (*)	100 °C/min (*)
<b>Maximum Cooling Rate</b>	100 °C/min (*)	100 °C/min (*)	100 °C/min (*)	100 °C/min (*)
<b>Atmosphere</b>	Air (oxidizing), inert, reducing, vacuum	Air (oxidizing), inert, reducing, vacuum	Air (oxidizing), inert, reducing, vacuum	Air (oxidizing), inert, reducing, vacuum
<b>Adjustable Force Range</b>	0.01 to 1 N	0.01 to 1 N	0.01 to 0.5 N	0.01 to 0.5 N

(\*) Depending on furnace option. See furnace specifications for full details.

# DIL 820 AND 830 SERIES | FURNACE OPTIONS

A range of dynamic furnaces are available for the DIL 820 and 830 series featuring motorized operations, high performance insulation, active cooling, and are optimized for minimum internal volume.

<b>Max Furnace Temperature</b>	-160°C to 700°C	RT to 1100°C	RT to 1500°C	RT to 1700°C	RT to 2300°C
<b>Sample Temperature Range</b>	-150°C to 650°C	RT to 1000°C	RT to 1470°C	RT to 1680°C	RT to 1980°C 300°C to 2300°C
<b>Heating Element</b>	NiCr with sheath	CrAl Fe	Pt/Rh	Pt/Rh	Graphite
<b>Measuring System</b>	Fused silica	Fused silica	Alumina	Alumina	Graphite
<b>Max Heating Rate</b>	50°C/min	60°C/min	100°C/min	100°C/min	50°C/min
<b>Max Controlled Cooling Rate</b>	25°C/min	25°C/min	15°C/min	5°C/min	100°C/min
<b>Natural Cooling Time (min) (from max temp to 25 °C)</b>	22 min	51 min	53 min	54 min	22 min
<b>Model Compatibility</b>	820	820, 830	820, 830	820, 830	820



820 Series Dynamic Furnace

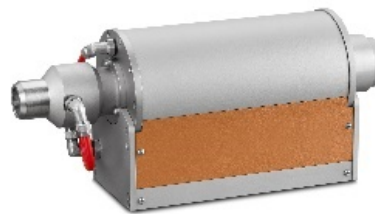

830 Series Dynamic Furnace



820 Series  
High Temperature Furnace

## HORIZONTAL DILATOMETER | DIL 800 SERIES

All TA Instruments 800 Series horizontal dilatometers are precision instruments employing state-of-the-art Linear Variable Differential Transducer (LVDT) and digital amplifier technology. They are available in single-sample, dual-sample, and True Differential™ configurations. Version "L" models perform tests in air only, making them ideally suited for characterizing ceramics or other materials processed in air. Standard models can be run in air, inert, reducing, or vacuum atmospheres. These industry tested, rugged dilatometers can be configured with a variety of furnaces to meet the widest range of applications.



# Traditional **HORIZONTAL DESIGN,** **INDUSTRY TESTED,** **RUGGED** and **RELIABLE DILATOMETERS**

## Features and Benefits:

- TA Instruments unique True Differential™ measurement design with industry leading CTE accuracy of  $0.01 \times 10^{-6} \text{ K}^{-1}$  (DIL 802 models)
- High sensitivity Linear Variable Differential Transducer (LVDT) measuring head with digital amplifier technology, thermally-stabilized and designed to be shock-proof for industry leading sensitivity, accuracy, precision and ruggedness
- Available in dual-sample configuration and combined with interchangeable furnaces to maximize productivity in any lab (DIL 803 models)
- Available in air-only configurations for traditional ceramics testing ("L" models)
- Wide range of easily interchangeable furnaces provides the utmost in configuration flexibility and allows -150°C to 1700°C temperature range on a single instrument
- Furnaces can be operated in air (oxidizing), inert, reducing, or vacuum atmospheres to meet widest range of applications.
- Complies to all major standard test methods including: ASTM C372, ASTM E228, DIN 52328, ASTM C531, ASTM E831, DIN 53752, ASTM C824, DIN 51045, SEP 1680, ASTM D696, DIN 51909, SEP 1681

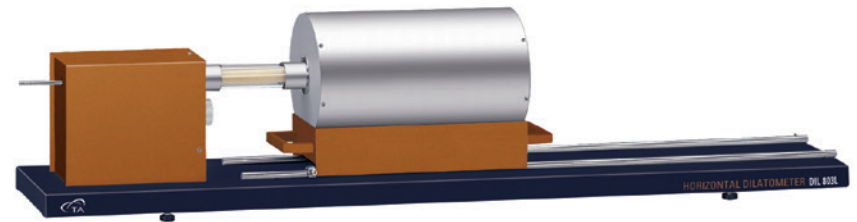

DIL 801L, DIL 802L, DIL 803L Dilatometers



DIL 801, DIL 802, DIL 803 Dilatometers



# DIL 800 SERIES | TECHNOLOGY

## Rugged and Reliable Transducer Technology

All 800 Series horizontal dilatometers are precision instruments employing state-of-the-art Linear Variable Differential Transducer (LVDT) and digital amplifier technology. These transducers are thermally-stabilized and designed to be shock-proof for the ultimate in sensitivity, accuracy, precision and ruggedness. Every dilatometer is capable of applying a wide range of user-defined contact forces (0.02 N to 1.00 N) so that efficient contact is maintained even during processes that may involve contraction of the sample. This ensures measurement accuracy and repeatability.

## Industry Leading CTE Accuracy with Unique True Differential™ Design

The DIL 802 features a True Differential™ measurement design that maximizes precision and accuracy. Many two-sample dilatometers can operate in differential mode, in which the signals from two separate transducers are subtracted from one another. Unlike these “software differential” instruments, the DIL 802 is designed specifically for the high performance of True Differential™ operation. At the heart of the DIL 802 is a single displacement transducer with an innovative measurement design that reduces noise and maximizes accuracy. The core of the differential transducer is coupled to the reference specimen while the coil of the transducer is coupled to the sample. The transducer’s frame of reference moves with system expansion, leaving only the excess sample expansion to be measured. This results in industry leading CTE accuracy of  $0.01 \times 10^{-6} \text{ K}^{-1}$ , reduced reliance on system calibration, and increased temperature program flexibility.

## Dual-Sample Design for Higher Productivity and Flexibility

To maximize sample throughput, the DIL 803 models offer dual-sample simultaneous operation in a horizontal dilatometer. They can also be operated as a differential system, using an inert reference specimen to reduce the influence of system expansion, increasing accuracy under dynamic temperature conditions. Combined with TA’s easily interchanged furnaces that reduce cooling time between experiments, the DIL 803 models maximize productivity in any lab.

## “L” Models Ideal for Testing of Traditional Ceramics

The DIL 80xL Series is designed to determine linear dimensional changes through a wide temperature range in air environment only, making them ideally suited for characterizing traditional ceramic materials.

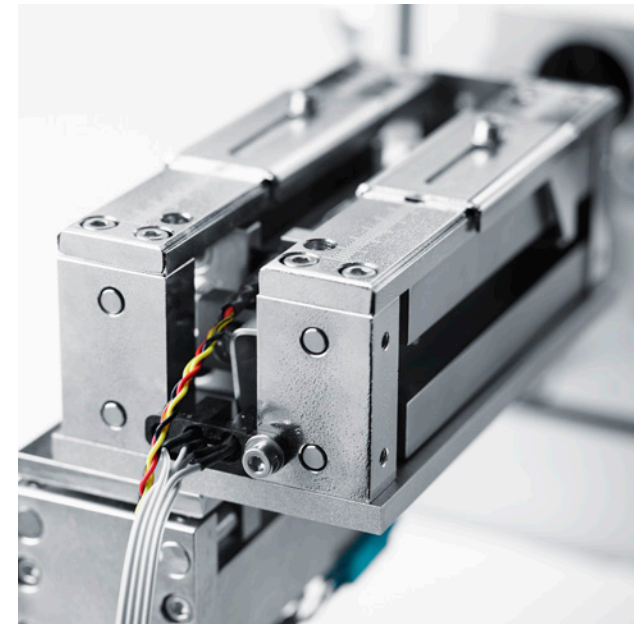

DIL 802 True Differential™ transducer

### Accurate and Consistent Over Broad Temperature Range

Often high-performance materials are exposed to extreme temperature swings while in application, and it is very important to have accurate measurements of the dimensional changes that these materials experience. The 802 True Differential™ Dilatometer provides superior CTE accuracy and can be configured with multiple furnaces to cover a broad temperature range of -160°C to 1700°C. This capability is demonstrated for a Sapphire reference standard with results shown in the figure to the right. Here the thermal expansion was measured from -150°C to 1500°C using switchable furnaces: the cryogenic furnace and a 1700°C furnace. Note that all the measurements fall well within ±0.5% of the reference values and it is important to recognize the agreement of the values, between ambient and 600°C where there is overlap in the data between furnaces.

Sapphire Standard: CTE Measurements from -150°C to 1500°C

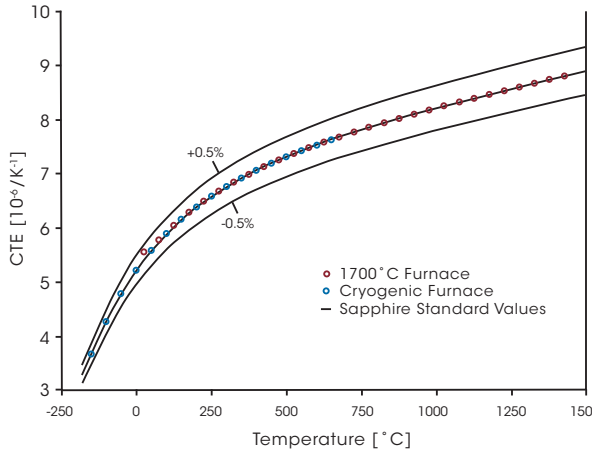

### Rapid Cooling Dynamic Furnace for Traditional Ceramics

The DIL 80xL Series features a new high performance 1100°C furnace designed specifically to meet the testing needs for traditional ceramics materials. This new furnace is constructed with high-performance insulation and includes an innovative active air cooling system providing unprecedented cool-down times. The figure to the right shows the performance of the furnace cooling from 1000°C to 25°C in only 13 minutes. In the event the material being tested is atmosphere sensitive, and forced-air cooling cannot be used, the total cool-down time is still only 35 minutes. Both cool down times are unmatched in dilatometry, enabling the prompt use of the instrument for a new test and guaranteeing high throughput without the need for expensive duplicate furnaces.

Rapid Cooling of Furnace from 1000°C to RT in Under 15 Minutes

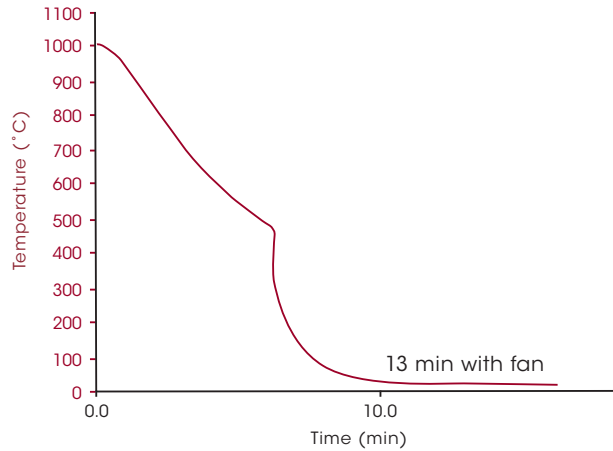

## DIL 800 SERIES | FURNACE OPTIONS

All DIL 800 Series horizontal dilatometers can be configured with a wide range of furnace options depending on the temperature range requirements. Furnaces are easily interchangeable, providing the utmost in configuration flexibility. Multiple furnaces of the same type can also be used to increase throughput on a single instrument.

<b>Temperature Range</b>	-160 to 700 °C	RT to 1100 °C	RT to 1350 °C	RT to 1500 °C	RT to 1700 °C
<b>Sample Temperature Range</b>	-150 to 650 °C	RT to 1000 °C	RT to 1320 °C	RT to 1470 °C	RT to 1680 °C
<b>Heating Element</b>	NiCr with sheath	CrAl Fe	CrAl Fe	SiC	Pt/Rh
<b>Measuring System</b>	Fused silica	Fused silica	Alumina	Alumina	Alumina
<b>Max Heating Rate</b>	50 °C/min	100 °C/min	100 °C/min	25 °C/min	25 °C/min
<b>Max Cooling Rate</b>	25 °C/min	25 °C/min	10 °C/min	15 °C/min	5 °C/min
<b>Model Compatibility</b>	801, 802, 803		801, 801L, 802, 802L, 803, 803L		



# DIL 800 SERIES | SPECIFICATIONS

Parameter	801	802	803	801L	802L	803L
<b>Horizontal Push-rod Design</b>	Single	True Differential™	Dual	Single	True Differential™	Dual
<b>Maximum Sample Length</b>	50 mm	50 mm	50 mm	50 mm	50 mm	50 mm
<b>Maximum Sample Diameter</b>	14 mm (*)	7 mm (*)	7 mm (*)	14 mm (*)	7 mm (*)	7 mm (*)
<b>Displacement System</b>	LVDT	LVDT	LVDT	LVDT	LVDT	LVDT
<b>Length (ΔL) Resolution</b>	10 nm	10 nm	10 nm	20 nm	20 nm	20 nm
<b>Measuring Range</b>	4 mm	4 mm	4 mm	4 mm	4 mm	4 mm
<b>CTE Accuracy</b>	0.03 10 <sup>-6</sup> K <sup>-1</sup>	0.01 10 <sup>-6</sup> K <sup>-1</sup>	0.03 10 <sup>-6</sup> K <sup>-1</sup>	0.03 10 <sup>-6</sup> K <sup>-1</sup>	0.01 10 <sup>-6</sup> k <sup>-1</sup>	0.03 10 <sup>-6</sup> k <sup>-1</sup>
<b>Sample Holders</b>	Fused Silica or Alumina	Fused Silica or Alumina	Fused Silica or Alumina	Fused Silica or Alumina	Fused Silica or Alumina	Fused Silica or Alumina
<b>Temperature Range</b>	-160 °C to 1700 °C (*)	-160 °C to 1700 °C (*)	-160 °C to 1700 °C (*)	RT to 1700 °C (*)	RT to 1700 °C (*)	RT to 1700 °C (*)
<b>Maximum Heating Rate</b>	100 °C/min (*)	100 °C/min (*)	100 °C/min (*)	100 °C/min (*)	100 °C/mm (*)	100 °C/min (*)
<b>Maximum Cooling Rate</b>	25 °C/min (*)	25 °C/min (*)	25 °C/min (*)	25 °C/min (*)	25 °C/min (*)	25 °C/min (*)
<b>Atmosphere</b>	Air (oxidizing), inert, reducing, vacuum	Air (oxidizing), inert, reducing, vacuum	Air (oxidizing), inert, reducing, vacuum	Air	Air	Air
<b>Adjustable Force Range</b>	0.01 to 1 N	0.01 to 1 N	0.01 to 1 N	0.02 to 1 N	0.02 to 1 N	0.02 to 1 N

(\*) Depending on furnace option. See furnace specifications for full details.

## OPTICAL DILATOMETER | DIL 806

TA Instruments' patented Shadow-Meter technology<sup>(1)</sup> allows contactless measurements of thermal expansion and contraction of thin or irregularly shaped samples of soft materials. Unaffected by system thermal expansion that can be caused by changes in temperature, the DIL 806 offers an intrinsically absolute measurement and does not need the test-specific calibrations that are required with traditional push-rod dilatometers.

(1) US Patent No. 7.524.105

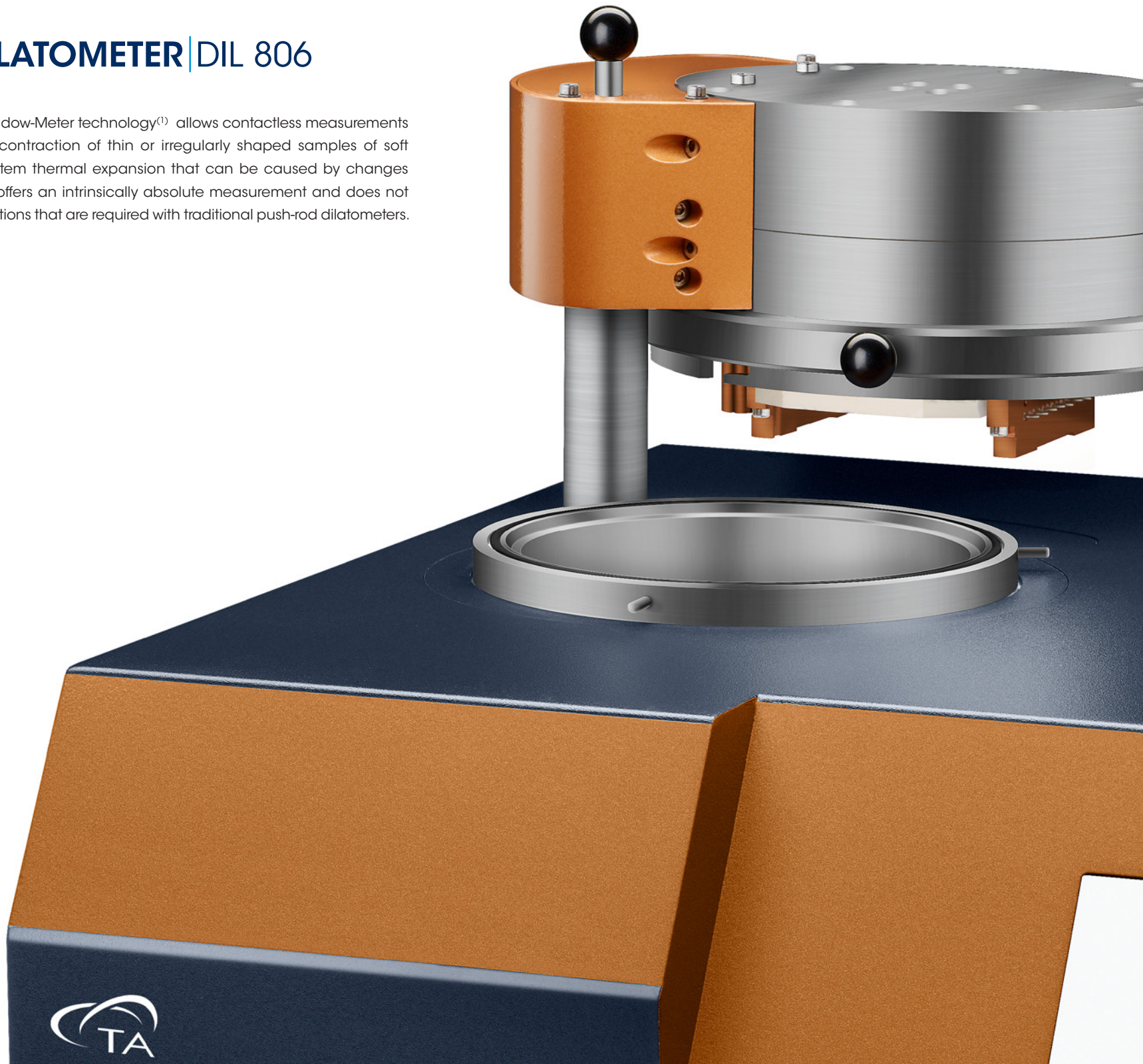

# CONTACTLESS MEASUREMENTS

## make Unconventional Dilatometry

# POSSIBLE

### Features and Benefits:

- Patented design requires no contact with sample allowing for maximum flexibility in sample type and preparation, including the ability to measure thin films, irregular shapes, transparent and translucent materials, and soft materials otherwise not possible on traditional push-rod systems
- Design eliminates the need for measurement system calibrations and corrections, providing absolute measurement of sample response
- A single sample can be measured in several directions, allowing for the determination of the anisotropic thermal expansion in composites or other oriented materials
- Free of contact points, such as push-rods, ensures the sample is at a uniform temperature throughout the experiment, regardless of the experimental profile
- Innovative plate-shaped dynamic furnace provides superior temperature uniformity, response time, and rapid heating and cooling rates for measurement accuracy and high sample throughput
- Three different temperature ranges for maximum flexibility: -150°C to 600°C, RT to 900°C, or RT to 1400°C
- Greatly simplified sample loading with easy access to the sample chamber and measurement area removes restrictions on sample positioning
- Initial sample length is automatically measured and recorded, eliminating the potential for human error

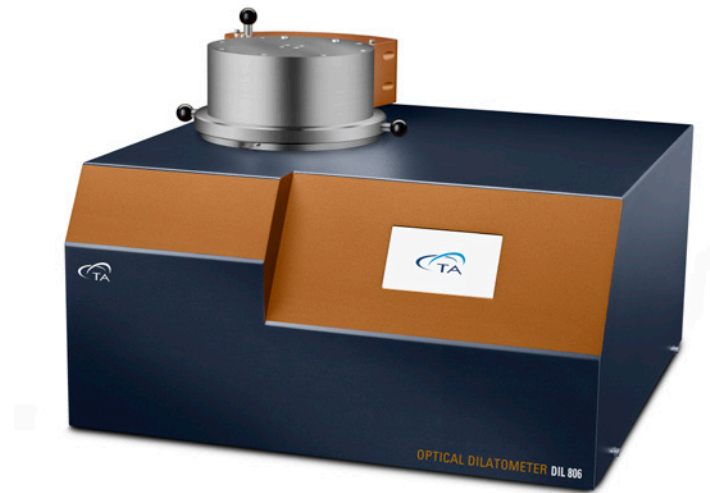

DIL 806 Optical Dilatometer

**The DIL 806 Optical Dilatometer uses an innovative new measurement principle to make unconventional dilatometry experiments possible, and to improve many conventional tests.**

## Measurement Principle

The DIL 806 operates by the shadowed light method, in which the absolute sample size is determined in one direction by measuring the shadow it casts on a high precision Charge-Coupled Device (CCD) detector. A high intensity GaN LED emits a plane of light that is passed through a diffusion unit and collimating lens to produce a highly uniform, short wavelength, plane of light. The sample blocks transmission of a portion of this light. This now "shadowed light" is refined through a telecentric optical system and recorded by the CCD which provides a length resolution of 50 nm. Digital edge detection automatically determines the width of the shadow, and therefore the dimension of the sample.

## Absolute Measurement Advantages

The DIL 806 non-contact design makes an intrinsically absolute measurement and therefore it is unaffected by system thermal expansion resulting from programmed temperature changes. Only the sample is subjected to temperature excursions; both the light source and detector are well-isolated from these changes. Consequently, the measurement is absolute and the test-specific calibrations that are common with push-rod dilatometers are not required.

## Furnace Technology

The DIL 806 features an innovative plate-shaped furnace offering a wide temperature range of -150°C to 1400°C (\*) and superior uniformity and response time. The sample is positioned centrally within the wide planar heating element, which is much larger than the sample, preventing thermal gradients in the lateral direction. A similar heating element in the furnace lid is positioned immediately above the sample, minimizing vertical temperature gradients.

The furnace can heat rapidly at speeds up to 100 °C/min and can cool from 1400°C to 50°C in under 10 minutes. These rapid rates enable high sample throughput, or characterizing materials with processes that undergo large and rapid temperature changes. The dynamic furnace response also makes the DIL 806 especially well-suited to Rate-Controlled Sintering experiments, fully supported by the instrument control software which permits user defined target sintering (contraction) rates. The temperature profile is then adjusted to achieve this by increasing or decreasing the heating rate in real-time response to the sample behavior.

(\*) Depending on furnace option. See furnace specifications for full details.

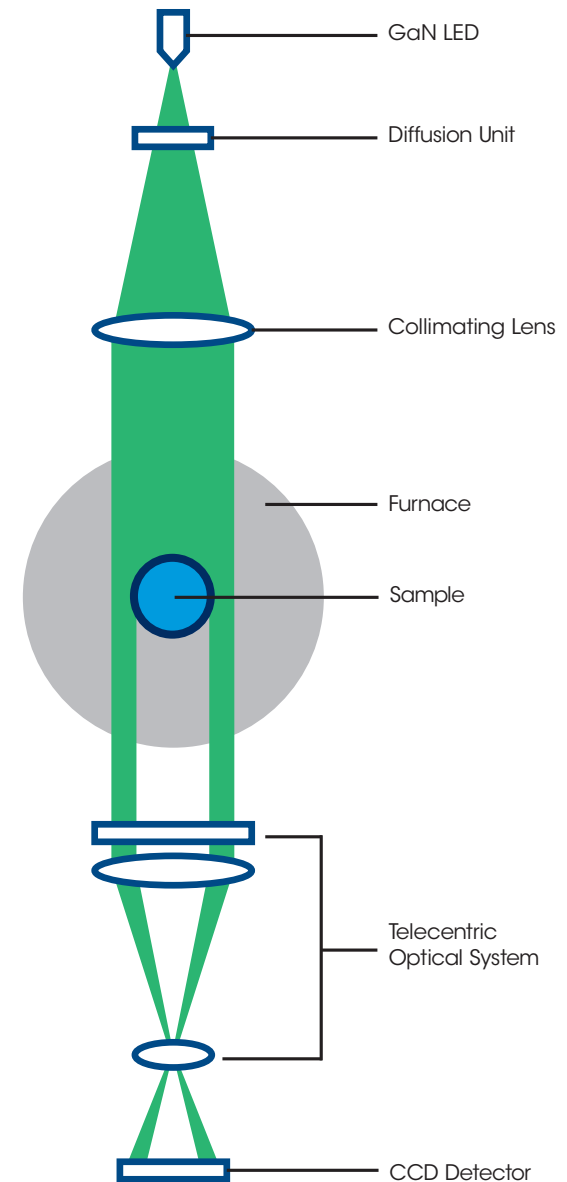

**Shadow-Meter Design**

[1] US Patent # 7,524,105

Sample Loaded in DIL 806 Instrument

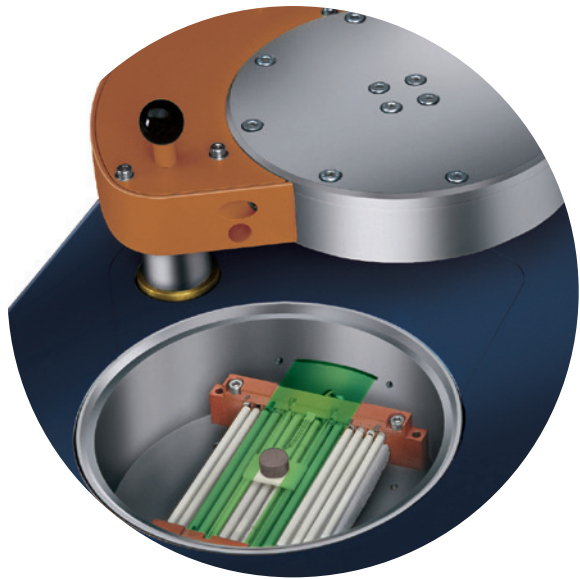

# The MANY BENEFITS of a NON-CONTACT MEASUREMENT

### Improved Temperature Uniformity

In traditional dilatometry, the pushrod can act as a heatsink at the point of contact between it and the sample. In optical dilatometry, the absence of physical contact between the measuring system and the sample eliminates the heatsink issue and enhances temperature uniformity during the measurement.

### Simplified Sample Loading

The DIL 806 has a 30 mm wide measurement area, shown in the picture at the top right. The instrument works equally well with a sample positioned anywhere in this range. This completely simplifies sample loading by providing ample room and removing restrictions on sample position.

### Maximum Sample Testing Flexibility

The lack of a push-rod contact removes the requirement for smooth or parallel faces, allowing testing of irregularly shaped samples without difficulty. In addition, because no load is applied to the sample, even the softest materials can be tested with the highest precision. These samples may include thin films, or materials that are inherently soft or experience a softening transition during the course of the experiment. For example, the measurement of a thin film in a push-rod dilatometer is difficult due to these contact forces. The DIL 806 optical dilatometer can easily characterize the thermal expansion and phase transformation of a thin steel foil, as shown in the figure to the left. Note sample holders to support thin films are available.

Dimension Change of a Thin Film with DIL 806

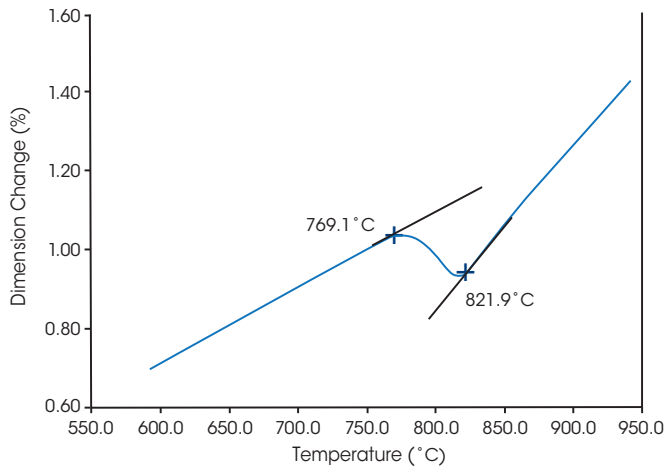



# OPTICAL DILATOMETRY PLATFORM | 860 SERIES

The 860 Series dilatometers are a unique and versatile line of instruments that employ patented<sup>1</sup> multi-directional optical bench technology, which enables non-contact measurements of multi-dimensional shape changes. The Optical Dilatometry Platform, ODP 868, is a single instrument that operates in four modes including: dilatometry, heating microscopy, relative fleximetry, and absolute fleximetry. The HM 867 is a stand alone Heating Microscope that is a standard instrument for process optimization in the ceramics industry.

(1) US Patents: #6,476,922 B2 & #6,767,127 B2

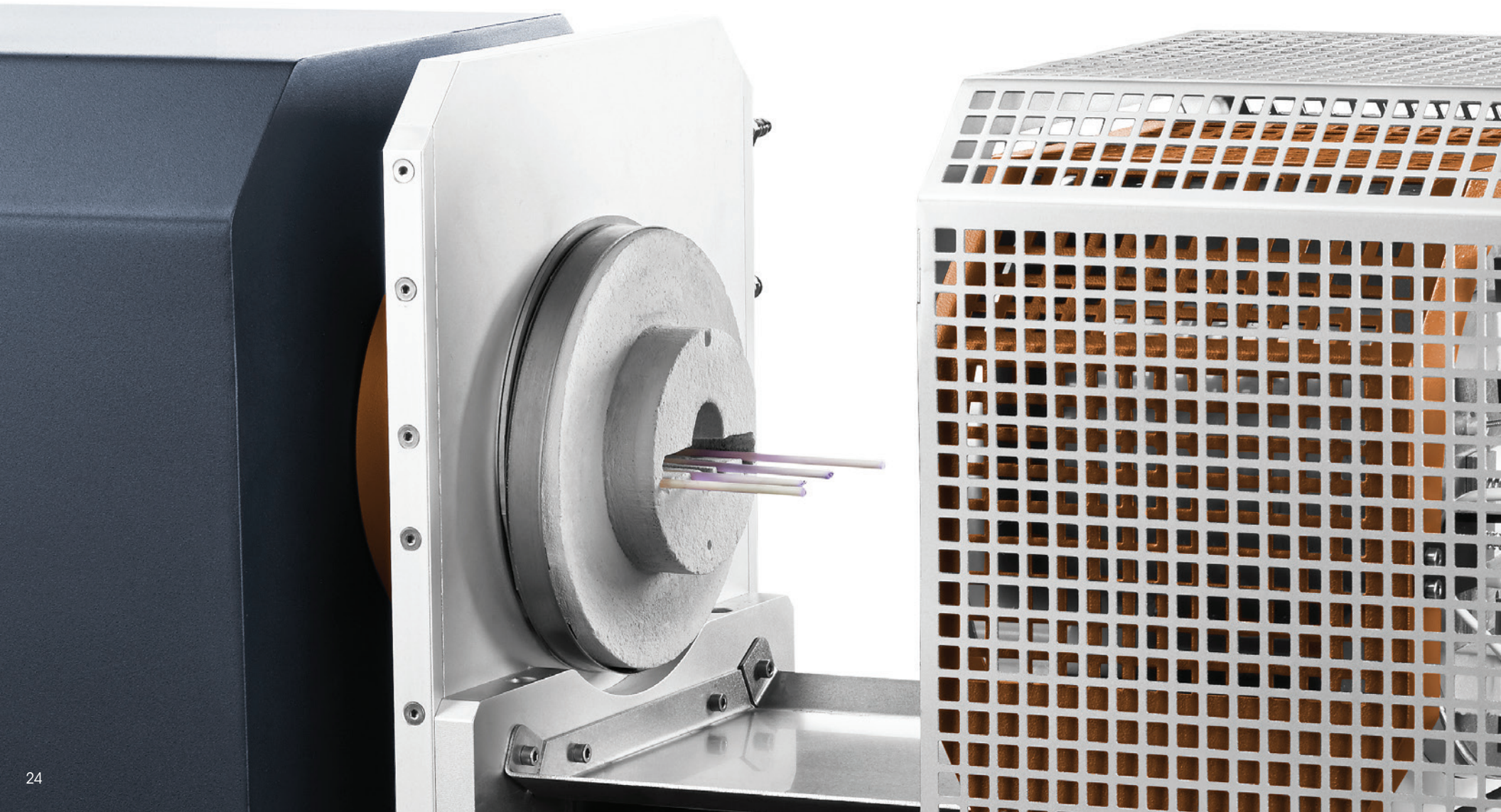

# NON-CONTACT measurements for **ABSOLUTE DATA**

## Features and Benefits:

- Only optical dilatometer featuring a multi-directional optical bench with patented technologies for the most accurate dilatometry, heating microscopy, and fleximetry available for the complete characterization of raw materials, semi-finished products, and process optimization
- Non-contact design provides maximum flexibility in sample type and preparation, including the ability to measure thin films, irregular shapes, and soft samples not possible on traditional push rod systems
- Patented multi-beam design provides absolute measurements of dimensional changes in a single run without the need of correction or calibration curves
- Thermally Stabilized Optical Bench Housing guarantees maximum performance and stability throughout the temperature range of the measurements
- Micro-stepper motor driven, high-resolution CMOS-based camera optics with dedicated lenses provide state-of-the-art imaging and precise automated XYZ positioning
- New highly responsive furnace with maximum temperature of 1650°C and heating rates up to 200°C/sec enables testing under thermal conditions which replicate actual manufacturing cycles
- Misura 4™ and MorphometriX™ software delivers innovative image analysis with proprietary algorithms and unmatched 14 fps acquisition rate, and provides ability to correct asymmetries in sample geometry with precision exceeding that of the human eye
- Configurable and upgradeable platform is available with any or all modes to meet current and future testing requirements
- Complies to all standard test methods for ash fusibility including: ASTM C372, ASTM D1857, CEN/TR 15404, BS 1016: Part 15, CEN/TS 15370-1, DIN 51730, ISO 12891, ISO 540, and NF M03-048



**ODP 868**  
Optical Dilatometry Platform

The 860 Series uses a high-powered LED light source to illuminate a sample suspended in a furnace. During the temperature program, four high definition cameras mounted on the multi-directional optical bench frame the sample and track dimensional changes in real time. This makes the 860 the only instrument capable of testing in dilatometry, heating microscopy, and fleximetry modes.

## Dilatometry

In dilatometry mode, two cameras on the optical bench frame the opposing edges of the sample and track the edges as the specimen expands or contracts during the experiment <sup>(1)</sup>. This allows the user to take advantage of all the benefits of non-contact dilatometry.

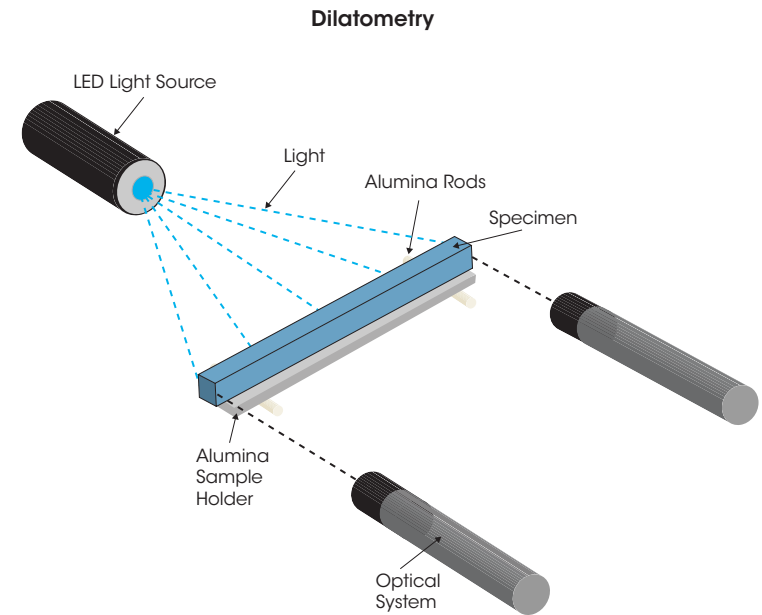

# Worlds most **VERSATILE** **OPTICAL DILATOMETRY PLATFORM**

## Heating Microscopy

In Heating Microscopy mode, a single camera on the optical bench frames the entire sample and records the sequence of the characteristic shape changes and the temperature throughout the experiment. This is ideal for identifying all key material change events including sintering, softening, full sphere, half sphere, and melting. Dimension changes up to 100% can be measured. The heating microscope is available as a stand-alone instrument, HM 867, or as an option on the Optical Dilatometry Platform, ODP 868.

## Fleximetry

Fleximetry can be conducted in both relative and absolute modes. In relative mode, one camera frames the lower center region of the sample to monitor very fast bending events as the temperature changes. In absolute mode<sup>(1)</sup>, three cameras on the optical bench frame the samples. One camera frames the center of the sample, while the other two are aimed on the lower edges adjacent to the supporting beams. This allows quantitative analysis of sample bending. This is ideal for the study of flexural behavior of materials undergoing simulated industrial firing cycles without application of loads.

(1) Patent Pending # PR2013A000064

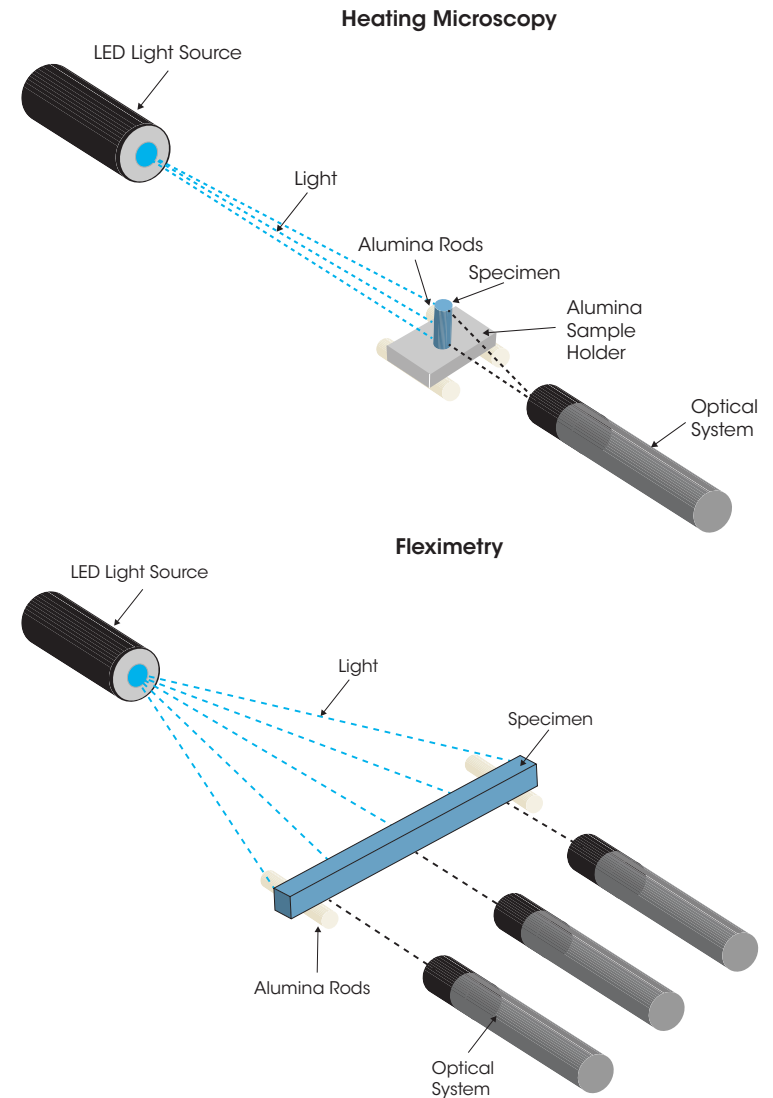

# 860 SERIES | TECHNOLOGY

## Advanced Patented Optical Design for Accuracy and Flexibility

The ODP 860 Series is the only optical dilatometer to feature a multi-directional optical bench with patented technologies for the most accurate dilatometry, heating microscopy, and fleximetry available. The optical bench features four fully automated cameras. Each optic includes a high-resolution CMOS-based camera and dedicated lens for state-of-the-art imaging, and is driven by micro-stepper motors for the most precise automated XYZ positioning.

The optical bench is enclosed in a temperature stabilized housing that guarantees maximum performance and stability throughout the temperature range of the measurements. The patented multi-beam design enables absolute measurements of dimensional changes in dilatometry and fleximetry modes, and eliminates the need for correction or calibration curves greatly simplifying experimental method optimization. The ODP 868 Multi-Directional Optical Bench can be purchased complete with all testing modes, or with the combination of any of the five modes, and upgraded in the future as testing requirements change or grow.

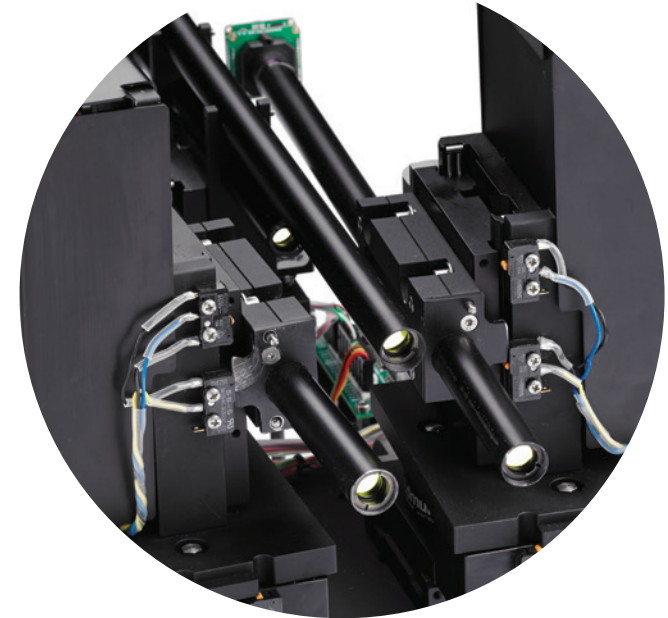

Multi-directional Optical Bench



Side-view of Optical Bench Cameras

### Highly Responsive Large Volume Furnace

The 860 Series features an all new furnace with a maximum temperature of 1650°C mounted on a precision stepper motor for automated opening and closing. This highly responsive furnace provides heating rates of up to 200°C/sec, enabling sample testing under environmental conditions which replicate those actually experienced in manufacturing.

The furnaces features large internal volume, providing the ability to test samples up to 85 mm long and 19 mm in height, meeting ASTM ash fusibility requirements. Alternatively, up to eight samples, with dimensions of 3 x 2 mm can be tested simultaneously for improved throughput. The furnace includes connections for air or inert gas purge which is preheated before it flows over the sample.

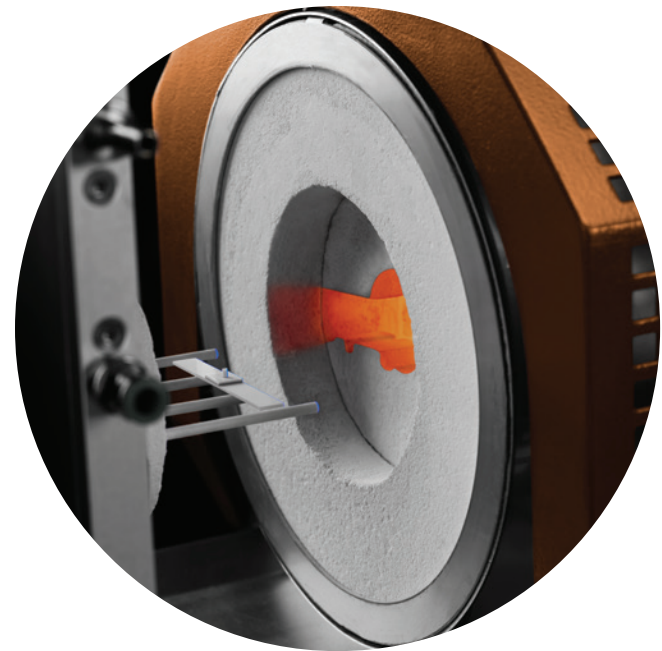

860 Furnace

## Measuring the True Softening Temperature with Optical Dilatometry

Traditional push-rod dilatometers cannot accurately measure the softening point of a material. This is because the contact of the push-rod on the soft sample results in large errors, the magnitude of which depends on the value of that force. Measured softening points can be understated by as much as 150°C or more. TA Instruments' suite of non-contact optical dilatometers makes characterizing the softening point of a material a simple test. The non-contact approach eliminates all the difficulties associated with push-rod systems as the sample is not under load. The figure to the right shows an example of linear thermal expansion and CTE for a glaze measured on the ODP 868. It can be seen here that the parameters are easily and correctly measured. In addition, the test can be continued to temperatures well beyond the softening point.

Thermal Expansion and CTE of Glaze Through Softening Temperature

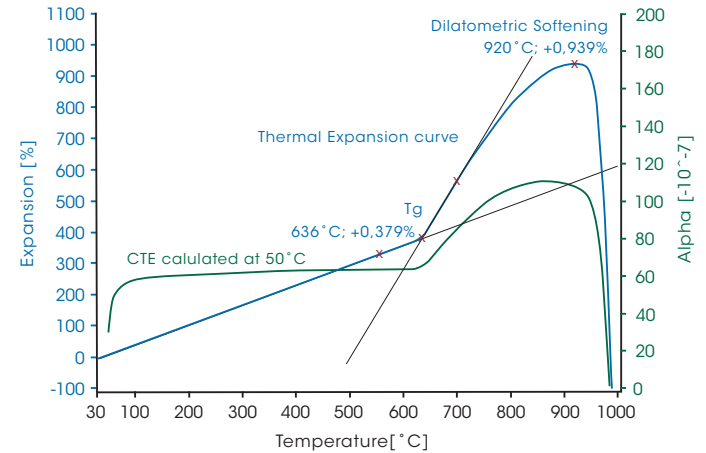

## Optical Dilatometry of Non Homogeneous Materials

Quartz sand is inexpensive and resistant to high temperatures. It is typically used for metal casting processes. The plot on the right shows thermal expansion and volume change of a coarse grained pure quartz sand green body bonded with a little PVA. The volume increase is in agreement with the theoretical decrease in density from alpha-Quartz and alpha-Cristobalite. The fragile coarse sample would be crushed by the load required to keep the push-rod in contact with the specimen. Dilatometry on such fragile samples can be performed only by using an optical dilatometer.

Coarse Quartz Sand Sample Tested in Vertical Dilatometry Mode

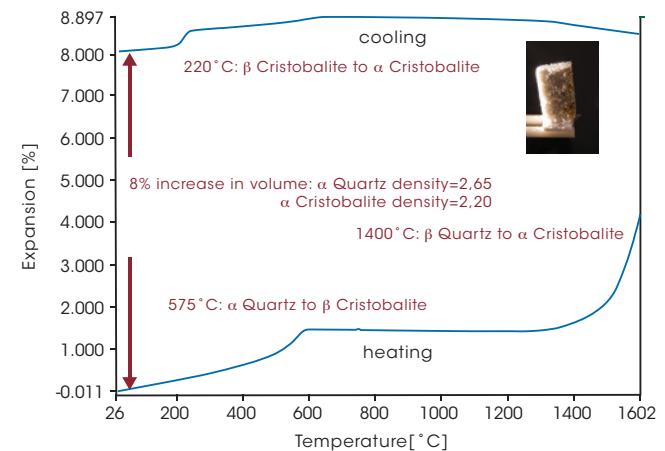

## A complete solution for dilatometry, Misura 4™ software suite includes Instrument Control, Data Analysis, MorphometriX™ and Graphics.

### • Client Server Architecture and Apps Based Structure

Through the App "Instrument Control" feature it is possible to set up analytical methods with an unlimited number of segments of duration and complexity. The user is able to import and export files to analyze and compare data from other dilatometers and different sources, though in different formats.

### • MorphometriX™ image analysis engine for automated identification of shape changes

A revolutionary shape analysis engine at the core of Misura 4™ software suite, MorphometriX™ translates the intuitive concept of shape into rigorous mathematical parameters with consistent physical foundations. It brings image analysis far beyond the classic geometrical parameters like height, width, perimeter, etc, or the characteristic shapes as softening, sphere, half-sphere or melting. Taking advantage of an acquisition rate of up to 14 fps, MorphometriX™ pattern-matching recognizes materials' transformations with precision, superseding the eye of the human operator and automatically identifying the specimen's shapes and temperatures.

### • MorphometriX™ geometry factors and customized models

TA Instruments' proprietary algorithms correct for possible sample geometry asymmetries and make measurements that are unaffected by the most common preparation and positioning issues. With MorphometriX™ the advanced user can easily implement customized algorithms and design next generation materials by teaching the software how to recognize unknown shapes and behavior, and, optimize the analytical method in real-time.

### • Misura 4™ Graphics, a tool for maximum reporting flexibility

Graphics allows the user to plot and analyze results with advanced mathematical tools, or to integrate additional data to calculate theoretical viscosity of materials according to V.F.T. equation, and the surface tension with the sessile drop method. Comprehensive reports can be interactively generated and rendered as vector PDF files; single or multiple frames can be selected and exported in web or video format (.AVI) for presentations; raw data can be imported and exported in CSV format.

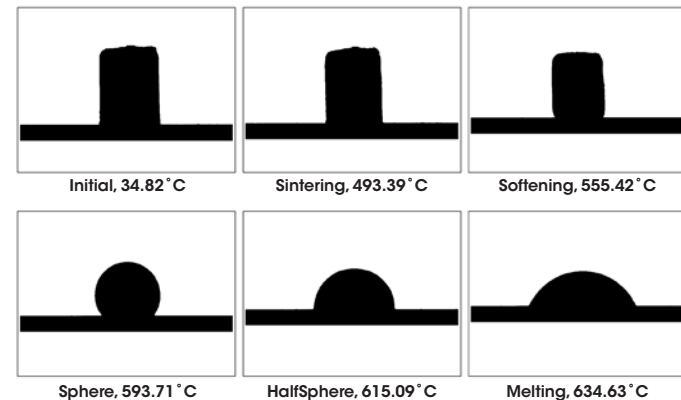
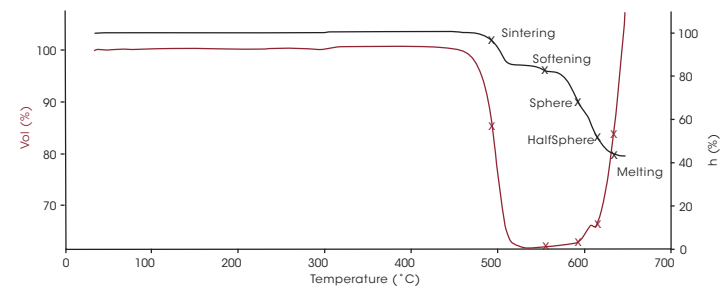
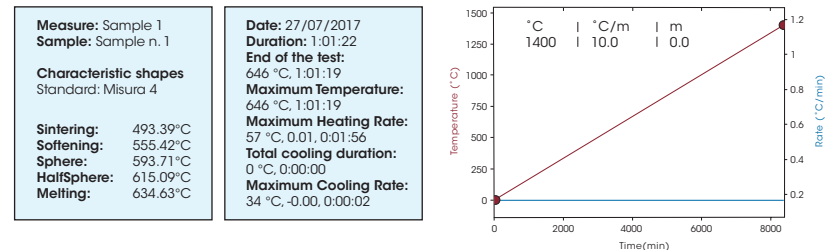

### Misura 4™ Graphics flexible reporting

A heating microscope report showing sample and method data, the changes of sample's height and volume as a function of the temperature, and material's characteristic shapes and their temperatures, all on one page. Graphics allows the user to easily tailor the report of any dilatometric test, import data from third party software, or export to third party reporting tools.



# DIL 806 AND 860 SERIES | SPECIFICATIONS

	DIL 806	ODP	HM 867
<b>Design</b>	Patented Shadow-Meter Horizontal Optical Dilatometer	<b>Scalable Optical Dilatometry Platform:</b> Patented Dual Beam Dilatometer Heating Microscope Patented Absolute Fleximeter Relative Fleximeter	Heating Microscope
<b>Sample Length</b>	0.1 to 30 mm	0.5 to 85 mm (*)	1 to 6 mm
<b>Sample Height</b>	2 to 10 mm	0.5 to 19 mm	0.5 to 19 mm
<b>Displacement System</b>	CCD sensor array	HD camera in Heating Microscope Dual optical system in Dilatometry Triple optical system in Fleximetry	HD camera
<b>Dimensional Change Resolution</b>	50 nm	3 ppm in Heating Microscope 250 nm in Dilatometry 500 µm in Fleximetry	5 ppm
<b>Measuring Range</b>	29 mm	19 mm (*)	19 mm
<b>CTE Accuracy</b>	0.05 10 <sup>-6</sup> K <sup>-1</sup>	0.2 10 <sup>-6</sup> K <sup>-1</sup> (Depending on OP-mode and sample size)	NA
<b>Temperature Range</b>	-170°C to 700°C RT to 900°C RT to 1400°C	RT to 1650°C	RT to 1600°C
<b>Actual Sample Temperature</b>	-150°C to 650°C RT to 900°C RT to 1350°C	RT to 1650°C	RT to 1600°C
<b>Heating Rate</b>	0.1 to 200 °C Depending on temperature range	0.2 to 100°C/min up to 200°C/sec in FlashMode	0.2 to 100°C/min up to 200°C/sec in FlashMode
<b>Atmosphere</b>	Air, inert gas, vacuum	Air,	Air
<b>Contact Force</b>	NA, contactless measurement	NA, contactless measurement	NA, contactless measurement

(\*) Depending on operational mode. See 860 Series Technology Section for full details.

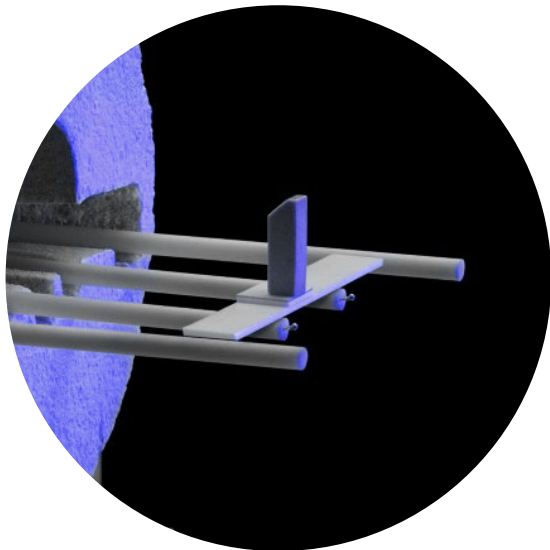

Sintering Study

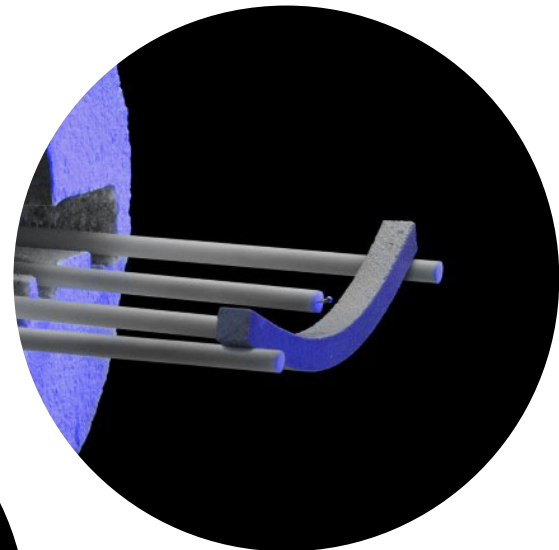

Pyroplasticity with Fleximeter

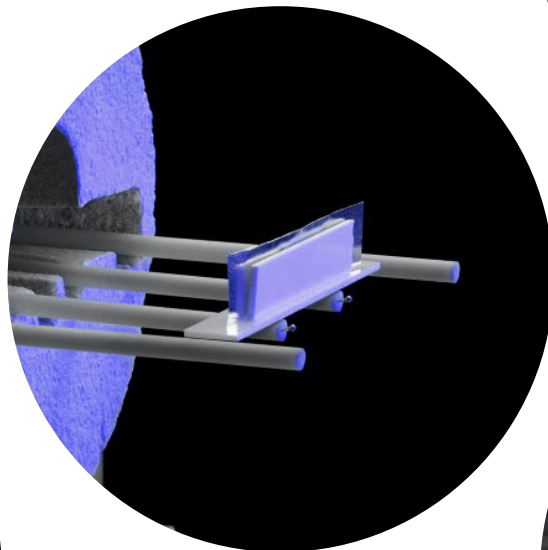

Thin Film Holder

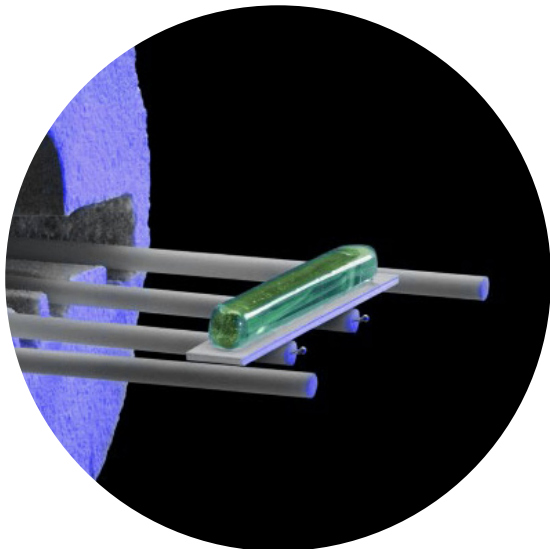

Expansion and Softening of a Glass with  
Horizontal Dilatometry

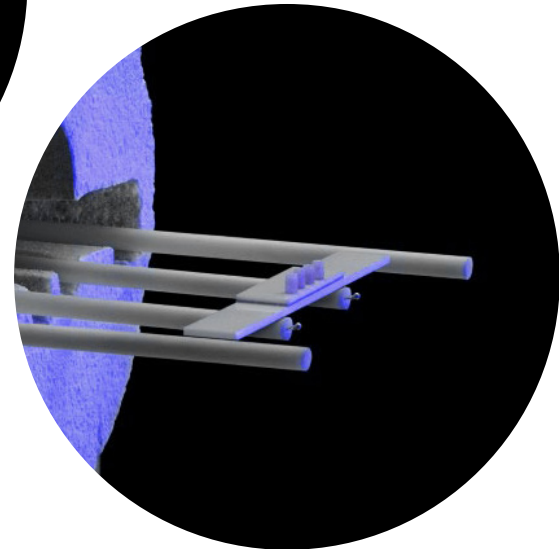

Mult Sample Heating Microscopy

# DILATOMETRY | APPLICATIONS

## Measurements of Glass Transition and Softening Temperature

Two important measurements commonly made on a dilatometer are the determinations of the glass transition temperature,  $T_g$ , and the softening point. The figure to the top right shows results of thermal expansion for glass material as measured on TA Instruments True Differential™ Dilatometer. It can be seen here that the sample was heated through the  $T_g$ , observed at 471.0°C, to the softening point, observed at a temperature of 540°C. The instrument control software includes a unique “automatic softening point detection” function to terminate the test. This feature allows these properties to be measured for unknown materials without concern of damage to the instrument that could result if the sample is melted and flows onto components.

Glass Transition and Softening Temperature

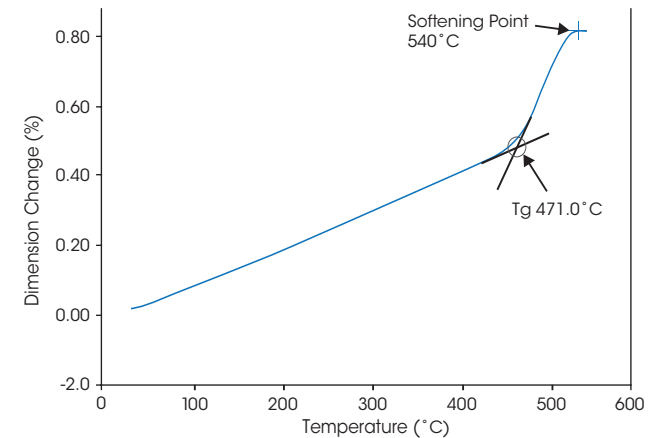

## Advantage of Vertical Dilatometer for Sintering

TA's unique vertical push-rod dilatometers are ideal for the study and optimization of sintering processes. When the sample is oriented in the vertical position, negligible force can be applied to the sample which minimizes excessive deformation that occurs in a horizontal dilatometer. In addition, the frictional interactions between the sample and the holder are also minimized. Both of these effects lead to incorrect shrinkage results in a horizontal dilatometer. In the example at the bottom right, the same ceramic body has been sintered both at constant heating rate and in Rate Controlled Sintering (RCS). Constant heating rate is preferred for faster sintering process and is usually employed for the manufacturing of traditional ceramic products. RCS maximizes the densification of the sample and is preferred in the advanced ceramics industry.

Sintering vs. Rate Controlled Sintering

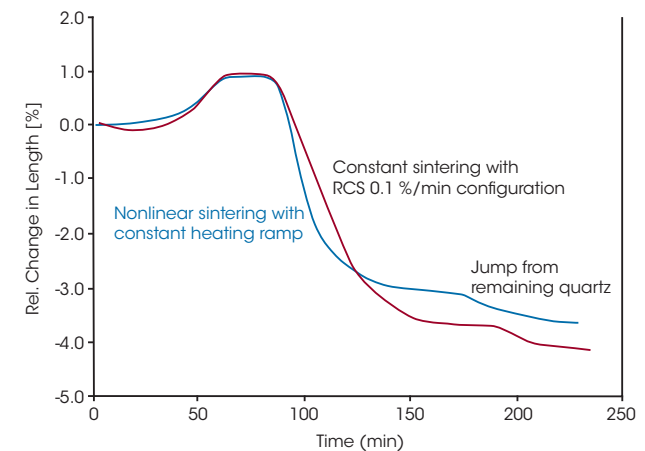

### Simulating a Fast Firing Cycle in the Lab with Optical Dilatometry

Fast firing of traditional ceramics has quickly become the preferred processing technology because of the reduction in cost and increased productivity it provides. Because fast firing requires all materials within the ceramic body to obtain optimal stabilization within a few minutes, some raw materials used in slower firing process may not be suitable. Therefore, it is important to understand the suitability of all raw materials in the laboratory before scaling a batch up for production. TA Instruments' optical dilatometer, ODP 868, includes a furnace capable of rapid heating and cooling, allowing the simulation of thermal profiles of fast firing kilns and eliminating the need for expensive and time-consuming pilot-scale tests. An example is shown in the figure at the top right. Here a green body was heated to 800°C in 4 minutes, then to 1220°C in 4.2 minutes, and held isothermally for five minutes to allow the body to fully sinter. Subsequently, the furnace was fast cooled to 680°C in 30 seconds and then to 100°C in 5.3 minutes. It can be seen in the figure that, at the end of the process, the sample was properly sintered and dimensionally stable.

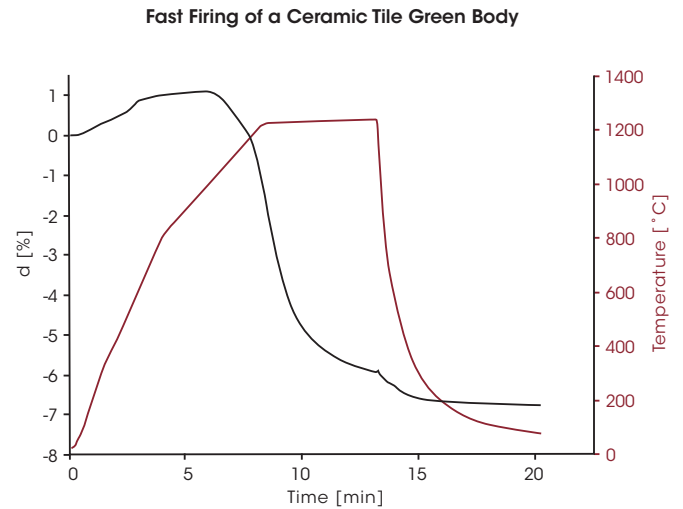

### Pyroplasticity Study of Sintered Bodies with Absolute Fleximeter

The ceramic tile market is trending towards larger formats and faces the challenge of reducing the tile thickness while maintaining planarity. Flatness defects can be induced during pressing, firing, or cooling. During firing, the amount of deformation is dependent on the viscosity of the glassy phases. The viscosity follows an Arrhenius relationship. However, some materials will exhibit a change in the composition of the glassy phase during the firing process which results in an increase of viscosity as the temperature increases. The figure to the right shows results of two different sintered bodies that were tested using the Absolute Fleximetry mode of the ODP 868. It can be seen here that "Sample A" starts bending, and as the temperature continues to increase, the sample can no longer support its own weight and ultimately flexes over 6 mm (i.e. 7.5%). "Sample B" shows dramatically different flexing behavior. For this sample, the softening vitreous phases dissolve other mineral components present in the body. As a result, the viscosity increases with the temperature, and the body tends to flex less. The latter result will produce a tile in a larger format that is easier to process and with better planarity.

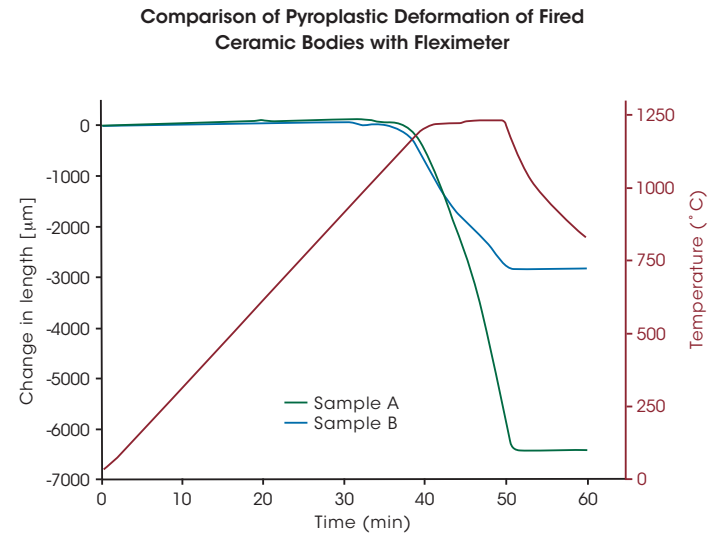

## Identification of Characteristic Shapes and Temperatures with Heating Microscopy

Heating microscopy identifies a material's characteristic shapes and corresponding temperatures, and is a must-have tool for optimizing manufacturing processes in ceramics, metals and alloys. The top right graph shows a comparison of two matt glazes. For Matt Glaze 1 all the five basic characteristic shapes were identified, and the data reveals the sample has a strong surface tension and a poor compatibility with the substrate of the sample holder. In contrast, Matt Glaze 2 not only melts at lower temperature but has a great degree of compatibility with the substrate. After Matt Glaze 2 melts, it spreads evenly over the surface of the substrates making it an ideal candidate for bodies of the same or similar composition of the substrate. The characteristic temperatures were automatically identified by MorphometriX™, TA Instruments' image analysis software engine equipped with pattern-matching models for recognition of transformations in materials in real-time with precision superseding the eye of a human operator.

## Characterization of Mold Powders for Continuous Casting

Mold powders are added to the top of molten steel in a continuous casting mold. The powder partially melts, forming a liquid layer next to the molten steel protecting it from reoxidation, absorbing the non-metallic inclusions, lubricating the steel shell as it passes through the mold, and controlling the heat transfer from the solidifying steel shell to the mold. If the mold powder does not readily flow, and completely covers the exposed surface of the molten steel, the thermal insulation it is meant to provide is not sufficient leading to unwanted reoxidation and inefficient removal of non-metallic inclusions. Because the melting behavior of mold powders is dependent on heating rate, it is very important to accurately measure this behavior at actual ballistic heating rates of the process to understand performance during the casting process. TA's Optical Dilatometer Platform, ODP 868, with flash and rapid heating capabilities is the perfect tool to characterize and understand this behavior. Because the approach is optical, there is no complicated sample preparation as would be the case with traditional push-rod instruments. The figure to the right shows melting points for a mold powder determined at 30°C/min, 80°C/min, and under the most rapid flash conditions. It can be seen that the melting point of the powder decreases with increasing heating rate.

Matt Glaze Characteristic Shape & Temperatures

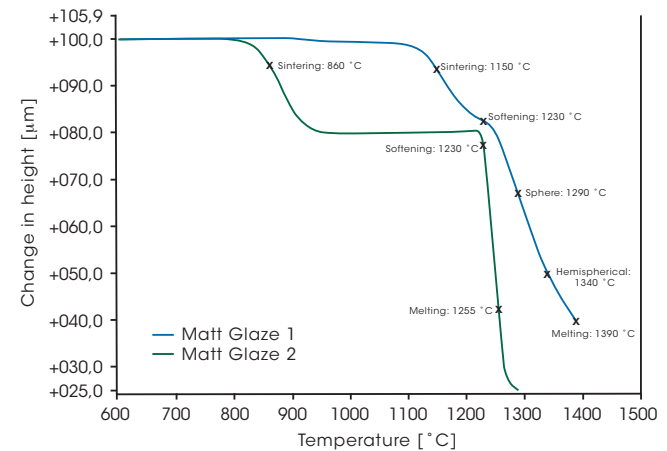

Mold Powder Melting Points

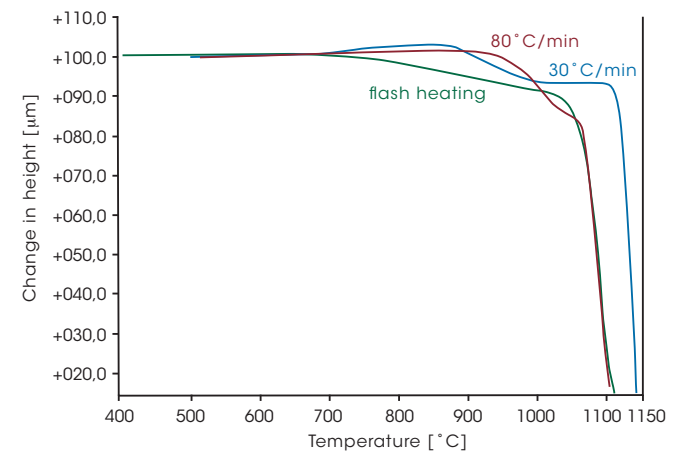

## Solid Oxide Fuel Cell Stack Compatibility Study

Solid Oxide Fuel Cells (SOFC) are devices that convert chemical energy into electrical and thermal energy by combining oxygen and hydrogen. The base of a SOFC cell consists of two porous electrode layers separated by a high-density oxygen-conducting electrolyte layer. The thickness of the entire structure is less than 1 mm. The fabrication process consists of forming the anode and cathode layers, deposition of the electrolyte, and co-sintering of the stack. It is important to understand the behavior of the layers during co-sintering to successfully process SOFC's because a mismatch in shrinkage leads to distortion of the final piece. It is virtually impossible to make these measurements on a traditional push-rod dilatometer because the layers are so thin and not mechanically self-supporting. However, such measurements are possible using TA's unique optical dilatometer and film sample holder. The graph to the right shows a sintering study of two materials proposed for an SOFC consisting of a 125  $\mu\text{m}$  thick Nickel/yttria-stabilized Zirconia ceramic metal (Ni-YSZ cermet) anode and 10  $\mu\text{m}$  thick YSZ electrolyte performed by TA Instruments' optical dilatometer with Thin Film Holder. It can be seen in the graph that the results measured by the optical dilatometer show significant mismatch of the shrinkage during sintering, demonstrating the two materials are incompatible for the co-sintering process.

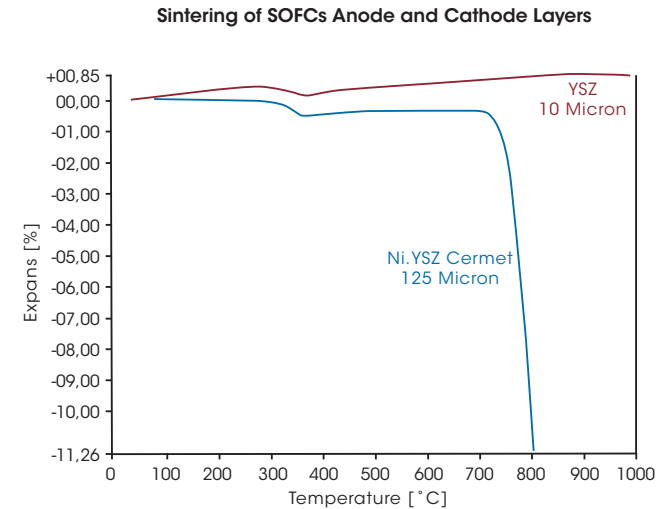

## Ash Flow Temperature of Solid Fuels

Coal, solid recovered fuel, wood and other biomasses are commonly burned to generate heat. During the combustion process, alkaline metals present in these fuels can generate complex eutectic salts and lower the melting point of the ashes. This causes fouling and slagging problems in heat exchangers and superheater tubes, leading to equipment damage and expensive downtime of the power plant. The ash flow temperature (AFT) of a solid fuel gives an indication to what extent ash agglomeration and ash clinking is likely to occur during gasification. The results of an AFT analysis consist of four temperatures, namely the initial deformation temperature (IDT), softening temperature (ST), hemispherical temperature (HT) and flow temperature (FT). These temperatures can be measured under either oxidizing or reducing conditions (or both), with the difference between the oxidizing and reducing results often correlating strongly with fluxing agents such as iron. Several standard methods, of which the most common are ASTM 1857, ISO 540 and DIN 51730, define how to prepare and test specimens. All methods require the use of a heating microscope like TA Instruments HM 867. The graph on the right shows a fusibility test performed on a 19 mm tall pyramidal coal sample according to ASTM standard 1857. The temperatures of the characteristic shapes were automatically determined with MorphometriX™ Software.

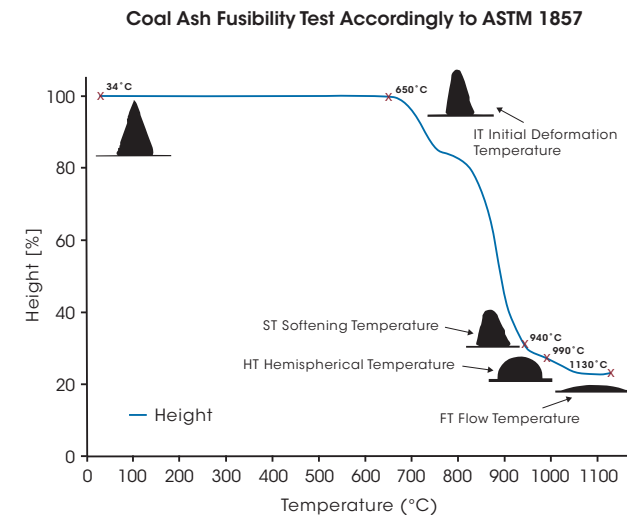

# Industry-Leading Sales & Support

TA Instruments' leadership position results from the fact that we offer the best overall product in terms of technology, performance, quality, and customer support. While each is important, our demonstrated commitment to after-sales support is a primary reason for the continued loyalty of our customers. To provide this level of support, TA Instruments has assembled the largest worldwide team of field technical and service professionals in the industry. Others promise good service. Talk to our customers and learn how TA Instruments consistently delivers on our promise to provide exceptional service.

With direct support staff in **23 countries** and **5 continents**, TA Instruments can extend its exceptional support to you, wherever you are.









## AMERICAS

- New Castle, DE USA
- Lindon, UT USA
- Eden Prairie, MN USA
- Chicago, IL USA
- Costa Mesa, CA USA
- Montreal, Canada
- Toronto, Canada
- Mexico City, Mexico
- São Paulo, Brazil

## EUROPE

- Hüllhorst, Germany
- Eschborn, Germany
- Elstree, United Kingdom
- Brussels, Belgium
- Etten-Leur, Netherlands
- Paris, France
- Barcelona, Spain
- Milano, Italy
- Warsaw, Poland
- Prague, Czech Republic
- Solna, Sweden
- Copenhagen, Denmark

## ASIA & AUSTRALIA

- Shanghai, China
- Beijing, China
- Tokyo, Japan
- Seoul, South Korea
- Taipei, Taiwan
- Guangzhou, China
- Petaling Jaya, Malaysia
- Singapore
- Bangalore, India
- Sydney, Australia



©2023 TA Instruments/Waters Corporation. Printed in the U.S.A.

**TA Instruments**

159 Lukens Drive  
New Castle, DE 19720 U.S.A.  
T: 1 302 427 4000  
F: 1 302 427 4041  
[www.tainstruments.com](http://www.tainstruments.com)

**Waters Corporation**

34 Maple Street  
Milford, MA 01757 U.S.A.  
T: 1 508 478 2000  
F: 1 508 872 1990  
[www.waters.com](http://www.waters.com)